

-- STATE OF NORTH CAROLINA--
DEPARTMENT OF TRANSPORTATION
RALEIGH, N.C.

SECOND INDUSTRY DRAFT RFP



DESIGN-BUILD PROJECT

TIP I-2304AC

December 23, 2009



VOID FOR BIDDING

DATE AND TIME OF TECHNICAL AND PRICE PROPOSAL SUBMISSION: **March 11, 2010 BY 4:00 PM**

DATE AND TIME OF PRICE PROPOSAL OPENING: **March 26, 2010 AT 2:00 PM**

CONTRACT ID: C202383

WBS ELEMENT NO. 34156.3.GV3

FEDERAL-AID NO. NHFIMF-085-3(197)81

COUNTY: ROWAN / DAVIDSON

ROUTE NO. I-85

MILES: 3.3

LOCATION: I-85 FROM NORTH OF SR 2120 (LONG FERRY ROAD) TO NORTH OF NC 150

TYPE OF WORK: DESIGN-BUILD AS SPECIFIED IN THE SCOPE OF WORK
CONTAINED IN THE REQUEST FOR PROPOSALS

NOTICE:

ALL PROPOSERS SHALL COMPLY WITH ALL APPLICABLE LAWS REGULATING THE PRACTICE OF GENERAL CONTRACTING AS CONTAINED IN CHAPTER 87 OF THE GENERAL STATUTES OF NORTH CAROLINA WHICH REQUIRES THE PROPOSER TO BE LICENSED BY THE N.C. LICENSING BOARD FOR CONTRACTORS WHEN BIDDING ON ANY NON-FEDERAL AID PROJECT WHERE THE BID IS \$30,000 OR MORE, EXCEPT FOR CERTAIN SPECIALTY WORK AS DETERMINED BY THE LICENSING BOARD. PROPOSERS SHALL ALSO COMPLY WITH ALL OTHER APPLICABLE LAWS REGULATING THE PRACTICES OF ELECTRICAL, PLUMBING, HEATING AND AIR CONDITIONING AND REFRIGERATION CONTRACTING AS CONTAINED IN CHAPTER 87 OF THE GENERAL STATUTES OF NORTH CAROLINA. NOT WITHSTANDING THESE LIMITATIONS ON BIDDING, THE PROPOSER WHO IS AWARDED ANY PROJECT SHALL COMPLY WITH CHAPTER 87 OF THE GENERAL STATUTES OF NORTH CAROLINA FOR LICENSING REQUIREMENTS WITHIN 60 CALENDAR DAYS OF BID OPENING, REGARDLESS OF FUNDING SOURCES.

5% BID BOND OR BID DEPOSIT REQUIRED

**PROPOSAL FORM FOR THE CONSTRUCTION OF CONTRACT NO. C202383
IN ROWAN AND DAVIDSON COUNTIES, NORTH CAROLINA**

Date _____ 20 _____

**DEPARTMENT OF TRANSPORTATION,
RALEIGH, NORTH CAROLINA**

The Design-Build Team herein acknowledges that it has carefully examined the location of the proposed work to be known as Contract No. C202383; has carefully examined the Final Request for Proposals (RFP) and all addendums thereto, specifications, special provisions, the form of contract, and the forms of contract payment bond and contract performance bonds, which are acknowledged to be part of the Contract; and thoroughly understands the stipulations, requirements and provisions. The undersigned Design-Build Team agrees to be bound upon their execution of the Contract and including any subsequent award to them by the Board of Transportation in accordance with this Contract to provide the necessary contract payment bond and contract performance bond within fourteen calendar days after the written notice of award is received by them.

The undersigned Design-Build Team further agrees to provide all necessary materials, machinery, implements, appliances, tools, labor, and other means of construction, except as otherwise noted, to perform all the work and required labor to design, construct and complete all the work necessary for State Highway Contract No. C202383 in Rowan and Davidson Counties by no later than the dates(s) specified in the Final RFP or Technical Proposal, whichever is earlier, and in accordance with the requirements of the Engineer, the Final RFP, the 2006 *Standard Specifications for Roads and Structures*, specifications prepared by the Department, the Technical Proposal prepared by the Design-Build Team, at the lump sum price(s) bid by the Design-Build Team in their Price Proposal.

The Design-Build Team shall provide signed and sealed documents prepared by the Design-Build Team, which specifications and plans show the details covering this project and adhere to the items noted above.

The Design-Build Team acknowledges that project documents furnished by the Department are preliminary and provided solely to assist the Design-Build Team in the development of the project design. Unless otherwise noted herein, the Department does not warrant or guarantee the sufficiency or accuracy of any information furnished by the Department.

The Department does not warrant or guarantee the sufficiency or accuracy of any investigations made, nor the interpretations made or opinions of the Department as to the type of materials and conditions to be encountered at the project site. The Design-Build Team is advised to make such independent investigations, as they deem necessary to satisfy their self as to conditions to be encountered on this project. The Design-Build Team shall have no claim for additional compensation or for an extension of contract time for any reason resulting from the actual conditions encountered at the site differing from those indicated in any of the information or documents furnished by the Department except as may be allowed under the provisions of the Standard Specifications.

Although the Department has furnished preliminary designs for this project, unless otherwise noted herein, the Design-Build Team shall assume full responsibility, including liability, for the

project design, including the use of portions of the Department design, modification of such design, or other designs as may be submitted by the Design-Build Team.

The Design-Build Team shall be fully and totally responsible for the accuracy and completeness of all work performed under this contract, and shall indemnify and hold the Department harmless for any additional costs and all claims against the Department or the State which may arise due to errors or omissions of the Department in furnishing the preliminary project designs and information, and of the Design-Build Team in performing the work.

The published volume entitled North Carolina Department of Transportation, Raleigh, *Standard Specifications for Roads and Structures*, JULY 2006, as well as, all design manuals, policy and procedures manuals, and AASHTO publications and guidelines referenced in the Request For Proposals, with all amendments and supplements thereto, are by reference, incorporated and made part of this contract; that, except as herein modified, all the design, construction and Construction Engineering Inspection included in this contract is to be done in accordance with the documents noted above and under the direction of the Engineer.

If the Design-Build Proposal is accepted and the award is made, the Technical Proposal submitted by the Design-Build Team is by reference, incorporated and made part of this contract. The contract is valid only when signed either by the Contract Officer or such other person as may be designated by the Secretary to sign for the Department of Transportation. The conditions and provisions herein cannot be changed except by written approval as allowed by the Request for Proposals.

Accompanying the Design-Build Proposal shall be a bid bond secured by a corporate surety, or certified check payable to the order of the Department of Transportation, for five percent of the total bid price, which deposit is to be forfeited as liquidated damages in case this bid is accepted and the Design-Build Team shall fail to provide the required payment and performance bonds with the Department of Transportation, under the condition of this proposal, within 14 calendar days after the written notice of award is received by them, as provided in the Standard Specifications; otherwise said deposit will be returned to the Design-Build Team.

**TO
BE
SEALED
IN
FINAL
RFP**

*Transportation Program
Management Director*

**TO
BE
SEALED
IN
FINAL
RFP**

State Contract Officer

TABLE OF CONTENTS

COVER SHEET

PROPOSAL SHEETS

PROJECT SPECIAL PROVISIONS	<small>(GREEN SHEETS)</small>	<i>PAGE NO.</i>
Contract Time and Liquidated Damages		1
Other Liquidated Damages		1
Progress Schedule		2
Payout Schedule		3
Mobilization		4
Substantial Completion.....		4
Submittal of Quantities, Fuel Base Index Price and Opt-Out Option		5
Partnering		6
Execution of Signature Sheets and Debarment Certification		7
Submission of Design-Build Proposals		7
Confidential Questions		8
Value Analysis		9
Schedule of Estimated Completion Progress.....		9
Revisions to FHWA 1273 Concerning Personal Information on Payroll Submissions .		9
Disadvantaged Business Enterprise		10
Certification for Federal-Aid Contracts.....		20
Required Contract Provisions for ARRA		20
Contractor's License Requirements		21
U. S. Department of Transportation Hotline.....		22
Subsurface Information		22
Bid Documentation.....		22
Twelve Month Guarantee		25
Outsourcing Outside the U.S.A.....		26
Clearing and Grubbing		26
SHPO Documentation for Borrow / Waste Sites		26
Erosion & Sediment Control / Storm Water Certification.....		27
Procedure for Monitoring Borrow Pit Discharge.....		33
Reinforced Concrete Pipe Design		34
Culvert Pipe		36
Drainage Pipe.....		37
Pipe Installation and Pipe Culverts		38
Cement & Lime Stabilization of Sub-Grade Soils		44
Price Adjustments for Asphalt Binder.....		48
Price Adjustments - Asphalt Concrete Plant Mix		49
Field Office		49
Automated Machine Guidance.....		51
Overhead Sign Supports		53
Overhead Sign Foundations.....		60

GENERAL (GREEN SHEETS) 70

SCOPES OF WORK (GREEN SHEETS)

Roadway 85
 Pavement Management 92
 Structures 96
 Geotechnical Engineering 99
 Hydraulics 107
 Traffic Management 109
 Incident Management 123
 Signing 125
 Pavement Markings 129
 Railroad Coordination 131
 Utilities Coordination 137
 Right of Way 144
 Erosion and Sedimentation Control 147
 Lighting 153
 Environmental 156
 Public Information 158

PERMITS (WHITE SHEETS) 160

STANDARD SPECIAL PROVISIONS (YELLOW SHEETS)

Liability Insurance 254
 Plant and Pest Quarantines 255
 Contractor Claim Submittal Form 255
 Gifts from Vendors and Contractors 256
 Embankments 256
 Shallow Undercut 257
 Flowable Fill 257
 Reinforced Bridge Approach Fill 258
 Fine Grading Subgrade, Shoulders and Ditches 260
 Aggregate Base Course 261
 Preparation of Subgrade and Base 261
 Aggregate for Soil – Cement Base 261
 Asphalt Pavements – Superpave 262
 Asphalt Paver – Fixed and Mobil String Line 276
 Asphalt Binder Content of Asphalt Plant Mixes 276
 Final Surface Testing – Asphalt Pavements 277
 Tying Proposed Concrete Pavement to Existing Concrete Pavement 280
 Concrete Pavements and Shoulders 281
 Guardrail Anchor Units, Type M-350 286
 Guardrail Anchor Units, Type 350 287

Impact Attenuators Units, Type 350 288

Fence..... 290

Preformed Scour Hole with Level Spread Apron 290

Street Signs and Markers and Route Markers..... 291

Steel U-Channel Posts 291

Shipping Signs 292

Galvanized High Strength Bolts, Nuts and Washers..... 292

Aggregate Production 292

Concrete Brick and Block Production 293

Portland Cement Concrete (Alkali-Silica Reaction) 293

Glass Beads 294

Engineering Fabrics Table 1056-1 294

Qualification of Welds and Procedures 294

Paint Sampling and Testing 295

Portable Concrete Barrier 295

Temporary Shoring..... 295

Changeable Message Signs..... 303

Pavement Marking Lines 303

Excavation, Trenching, Pipe Laying & Backfilling for Utilities 303

On-the-Job Training 303

Availability of Funds – Termination of Contracts 307

NCDOT General Seed Specification for Seed Quality 308

Errata 311

Award of Contract..... 315

Minority and Female Employment Requirements 316

Required Contract Provisions Federal-Aid Construction Contracts 319

General Decision Wages..... 329

Division One 333

PROPOSAL FORMS - ITEMIZED SHEET, ETC.

Itemized Proposal Sheet (WHITE SHEET)

Fuel Usage Factor Chart and Estimate of Quantities (WHITE SHEET)

Listing of DBE Subcontractors (YELLOW SHEET)

Execution of Bid, Noncollusion Affidavit & Debarment Certification (YELLOW SHEETS)

Signature Sheet (YELLOW SHEETS)

***** PROJECT SPECIAL PROVISIONS *******CONTRACT TIME AND LIQUIDATED DAMAGES**

04/15/07

DB1 G06

The date of availability for this contract is April 26, 2010, except that work in jurisdictional waters and wetlands shall not begin until a meeting between the DOT, Regulatory Agencies, and the Design-Build Team is held.

The completion date for this contract is defined as the date proposed in the Technical Proposal by the proposer who is awarded the project. The completion date thus proposed shall not be later than June 15, 2013.

When observation periods are required by the special provisions, they are not a part of the work to be completed by the completion date and/or intermediate contract times. Should an observation period extend beyond the final completion date, the acceptable completion of the observation period shall be a part of the work covered by the performance and payment bonds.

The liquidated damages for this contract are **Twenty Thousand Dollars (\$20,000.00)** per calendar day. As an exception to this amount, where the contract has been determined to be substantially complete as defined by the Project Special Provision "Substantial Completion" found elsewhere in this RFP, the liquidated damages will be reduced to **Five Thousand Dollars (\$5,000.00)** per calendar day.

Where the Design-Build Team who is awarded the contract has proposed a completion date for the contract as required above, but also has proposed an earlier date for substantial completion, then both of these proposed dates will become contract requirements.

Liquidated damages of **Twenty Thousand Dollars (\$20,000.00)** per calendar day will be applicable to the early date for substantial completion proposed by the bidder. Liquidated damages of **Five Thousand Dollars (\$5,000.00)** per calendar day will be applicable to the final completion date proposed by the bidder where the Design-Build Team has proposed an earlier date for substantial completion.

OTHER LIQUIDATED DAMAGES

(3/22/07) (Rev. 02/14/08)

DB1 G11

Refer to the Traffic Management Scope of Work for more information on the following time restrictions and liquidated damages:

Liquidated Damages for Intermediate Contract Time #1 for lane narrowing, lane closure, holiday and special event time restrictions for I-85 and all ramps is **\$10,000.00** per hour or any portion thereof.

Liquidated Damages for Intermediate Contract Time #2 for road closure time restrictions for I-85 and all ramps are **\$5,000.00** per 15-minute period or any portion thereof.

Liquidated Damages for Intermediate Contract Time #3 for road closure time restrictions exceeding the proposed closure duration committed to by the Design-Build Team for any ramp closure at the NC150 interchange is **\$4,000.00** per day or any portion thereof per each ramp.

PROGRESS SCHEDULE

(12-18-07)

DB1 G12

Revise the *2006 Specifications* as follows:

Page 1-72, Article 108-2 Progress Schedule, delete in its entirety and replace with the following:

The Design-Build Team shall prepare and submit for review and approval a schedule of proposed working progress. This schedule shall be submitted on forms supplied by the Engineer or in a format that is approved by the Engineer. A detailed Critical Path Method (CPM) schedule shall not be submitted to replace the progress schedule details required below.

The Design-Build Team shall submit a Progress Schedule for review within thirty (30) calendar days of receiving Notice of Award. The Department will review the Progress Schedule within twenty-one (21) calendar days of receipt. The Design-Build Team shall make any necessary corrections and adjustments to the Progress Schedule as necessitated by the Department's review within seven (7) calendar days. The Department will review the revised Progress Schedule within seven (7) calendar days of receipt.

When the Engineer has extended the completion date the Design-Build Team shall submit a revised progress schedule to the Engineer for review and approval. If plan revisions are anticipated to change the sequence of operations in such a manner as will effect the progress but not the completion date, then the Design-Build Team may submit a revised progress schedule for review and approval but the completion date shall remain unchanged.

The proposed progress schedule shall contain the following items:

- (A) A time scale diagram with major work activities and milestone dates clearly labeled.
- (B) A cash curve corresponding to the milestones and work activities established above.
- (C) A written narrative that explains the sequence of work, the controlling operation(s), intermediate completion dates, milestones, project phasing, anticipated work schedule, and estimated resources. In addition, explain how permit requirements, submittal tracking, and coordination with subcontractors, utility companies and other entities will be performed.

Major work activities are defined as components comprising more than 5% of the total project cost or occupying more than 10% of total contract time and shall include, if applicable, the following:

- Clearing and grubbing
- Grading
- Drainage
- Soil stabilization
- Aggregate base course
- Pavement
- Culverts
- Bridges (including removal)
- Signals and lighting
- Overhead signs
- Utility relocation and construction

Major Milestones are derived from the project construction phasing and shall include, if applicable, the following:

- Critical design submittal dates
- Critical permitting dates
- Completion of right of way acquisition
- Completion of Utility Conflicts
- Start of construction
- Intermediate completion dates or times
- Seasonal limitation /observation period s/ moratoriums
- Traffic shifts
- Beginning and end of each traffic control phase or work area
- Road openings
- Completion date

The Design-Build Team shall provide a written narrative each month detailing the work and percentage of work completed, anticipated sequence of upcoming work (2 month forecast), controlling operation(s), intermediate completion dates, and milestones. If any milestones are exceeded or will not be achieved, the Design-Build Team shall provide in the written narrative details of the delay; controlling operation affected, impacts to other operations, revisions to future intermediate completion dates and milestones, and remedial action necessary to get the project back to the original completion date.

PAYOUT SCHEDULE

(5-23-07)

DB1 G13

No later than 12:00 o'clock noon on the sixth day after the opening of the Price Proposal, the responsive proposer with the lowest adjusted price shall submit a proposed Anticipated Monthly Payout Schedule to the office of the State Contract Officer. The information shall be submitted in a sealed package with the outer wrapping clearly marked "Anticipated Monthly Payout Schedule" along with the Design-Build Team name and the contract number. The Anticipated

Monthly Payout Schedule will be used by the Department to establish the monthly funding levels for this project. The Anticipated Monthly Payout Schedule shall parallel, and agree with, the project schedule the Design-Build Team submits as a part of their Technical Proposal. The schedule shall include a monthly percentage breakdown (in terms of the total contract amount percentages) of the work anticipated to be completed. The schedule shall begin with the Date of Availability and end with the Actual Completion Date proposed by the Design-Build Team. If the Payout Schedule is not submitted as stated herein, the Technical and Price Proposals will be considered irregular by the Department, and the bid may be rejected.

Submit updates of the Anticipated Monthly Payout Schedule on March 15, June 15, September 15, and December 15 of each calendar year until project acceptance. Submit the all updates to the Resident Engineer with a copy to the State Construction Engineer at 1 South Wilmington St, 1543 Mail Service Center, Raleigh, NC 27699-1543.

MOBILIZATION

(10-31-05) (Rev 01-3-07)

DB1 G15A

Revise the 2006 *Standard Specifications for Roads and Structures* as follows:

Page 8-1, Subarticle 800-2, MEASUREMENT AND PAYMENT

Delete this subarticle in its entirety and replace with the following:

800-2 MEASUREMENT AND PAYMENT

5 percent of the “Total Amount of Bid for Entire Project” shall be considered the lump sum amount for Mobilization. Partial payments for Mobilization will be made beginning with the first partial pay estimate paid on the contract. Payment will be made at the rate of 50 percent of the lump sum amount calculated for Mobilization. The remaining 50 percent will be paid with the second partial payment.

SUBSTANTIAL COMPLETION

(3-22-07)

DB1 G16

When the special provisions provide for a reduction in the rate of liquidated damages for the contract time or an intermediate contract time after the work is substantially complete, the work will be considered substantially complete when the following requirements are satisfied:

1. Through traffic has been placed along the project or along the work required by an intermediate contract time and the work is complete to the extent specified below, and all lanes and shoulders are open such that traffic can move unimpeded at the posted speed. Intersecting roads and service roads are complete to the extent that they provide the safe and convenient use of the facility by the public.
2. The final layers of pavement for all lanes and shoulders along the project or along the work required by an intermediate contract time are complete.
3. All signs are complete and accepted except for the signs on intersecting roadways.

4. All guardrails, drainage devices, ditches, excavation and embankment are complete.
5. Remaining work along the project consists of permanent pavement markings, permanent pavement markers or incidental construction that is away from the paved portion of the roadway.

Upon apparent substantial completion of the entire project or the work required by an intermediate contract time, the Engineer will make an inspection of the work. If the inspection discloses the entire project or the work required by an intermediate contract time is substantially complete; the Engineer will notify the Design-Build Team in writing that the work is substantially complete. If the inspection discloses the entire project or the work required by an intermediate contract time is not substantially complete, the Engineer will notify the Design-Build Team in writing of the work that is not substantially complete. The entire project or the work required by an intermediate contract time will not be considered substantially complete until all of the recommendations made at the time of the inspection have been satisfactorily completed.

SUBMITTAL OF QUANTITIES, FUEL BASE INDEX PRICE AND OPT-OUT OPTION

(08-21-07)

DB1 G43

(A) Submittal of Quantities

Submit quantities on the *Fuel Usage Factor Chart and Estimate of Quantities* sheet, located in the back of this RFP, following the Itemized Proposal Sheet.

The Design-Build Team shall prepare an Estimate of Quantities that they anticipate incorporating into the completed project and upon which the Price Proposal was based. The quantity breakdown shall include all items of work that appear in the *Fuel Usage Factor Chart and Estimate of Quantities* sheet. Only those items of work which are specifically noted in the Fuel Usage Factor Chart will be subject to fuel price adjustments. The quantity estimate submitted in the Price Proposal shall be the final total quantity limit for which fuel price adjustments will be made for each item, regardless of supplemental agreements. The Department will review the Estimate of Quantities to ensure its reasonableness to the proposed design. Agreement of quantities will be a prerequisite prior to execution of the contract.

Submittal The submittal shall be signed and dated by an officer of the Design-Build Team. The information shall be copied and submitted in a separate sealed package with the outer wrapping clearly marked "Fuel Price Adjustment" and shall be delivered at the same time and location as the Technical and Price Proposal. The original shall be submitted in the Price Proposal.

Trade Secret Information submitted on the *Fuel Usage Factor Chart and Estimate of Quantities* sheet will be considered "Trade Secret" in accordance with the requirements of G.S. 66-152(3) until such time as the Price Proposal is opened.

(B) Base Index Price

The Design-Build Team's Estimate of Quantities will be used on the various partial payment estimates to determine fuel price adjustments. The Design-Build Team shall submit a payment request for quantities of work completed based on the work completed for that estimate period. The quantities requested for partial payment shall be reflective of the work actually accomplished for the specified period. The Design-Build Team shall certify that the quantities are reasonable for the specified period. The base index price for DIESEL #2 FUEL is \$ [REDACTED] per gallon.

(C) Opt Out of Fuel Price Adjustment

If the Design-Build Team elects not to pursue reimbursement for Fuel Price Adjustments, a quantity of zero shall be entered for all quantities in the *Fuel Usage Factor Chart and Estimate of Quantities* and the declination box shall be checked. Failure to complete this form will mean that the Design-Build Team is declining the Fuel Price Adjustments for this project.

(D) Change Option The proposer will not be permitted to change the option after the Price Proposal and the copy of the *Fuel Usage Factor Chart and Estimate of Quantities* sheet are submitted.

(E) Failure to submit the completed *Fuel Usage Factor Chart and Estimate of Quantities* sheet separately and in the Price Proposal will result in the Technical and Price Proposal being considered irregular by the Department and the Technical and Price Proposal may be rejected.

PARTNERING

04/03/07

DB1 G49

As a part of its quality management program, the North Carolina Department of Transportation intends to encourage the formation of a cohesive relationship with the Design-Build Team and its principal subcontractors and suppliers. This relationship will be structured to draw on the strengths of each organization to identify and achieve reciprocal goals. The objectives are safe, effective, and efficient contract performance; and completion within budget, on schedule, and in accordance with the plans and specifications.

This relationship will be bilateral in makeup and participation will be totally voluntary. The cost associated with effectuating this relationship will be agreed to by both parties and shall be shared equally. Compensation for the Department's share of the partnering costs will be by Supplemental Agreement.

To implement this initiative prior to starting work in accordance with the requirements of Section 108 of the Standard Specifications and the Standard Special Provision for Division One (found elsewhere in this RFP), and prior to the preconstruction conference, the Design-Build Team's management personnel and Division Construction Engineer will initiate a partnering

development seminar/team building workshop. Project personnel working with the assistance of the Construction Unit will make arrangements to determine attendees at the workshop, agenda of the workshop, duration, and location. Persons required to be in attendance will be the NCDOT Resident Engineer, the NCDOT Division Construction Engineer, and key project personnel; the Design-Build Team's senior management personnel, the Design-Build Team's on-site project manager, and key project supervisory personnel for both the Design-Build Team and principal subcontractors and suppliers. The project design engineers, FHWA, and key local government personnel will also be invited to attend as necessary.

Follow-up workshops may be held periodically throughout the duration of the contract as agreed by the Design-Build Team and the North Carolina Department of Transportation. In the event that additional workshops are held, compensation for the Department's share of the follow-up partnering workshops will be by Supplemental Agreement.

The establishment of the partnering charter on a project will not change the legal relationship to the contract nor relieve either party from any of the terms of the contract.

EXECUTION OF SIGNATURE SHEETS AND DEBARMENT CERTIFICATION

(9/07/05)

DB1 G52

The Proposer's attention is directed to the various sheets in the Request for Proposals which are to be signed by the Proposer. A list of these sheets is shown below. The signature sheets are located behind the Itemized Proposal Sheet in this Request for Proposal. The NCDOT bid bond form is available on-line at: <http://ncdot.org/doh/forms/files/bidbond.pdf> or by contacting the Records and Documents office at 919-250-4124.

1. Applicable Signature Sheets: 1, 2, 3, 4, 5, or 6 (Bid)

2. Bid Bond

The Proposer shall certify to the best of his knowledge all subcontractors, material suppliers and vendors utilized herein current status concerning suspension, debarment, voluntary exclusion, or determination of ineligibility by any federal agency, in accordance with the "Debarment Certification" located behind the *Execution of Bid Noncollusion Affidavit and Debarment Certification* signature sheets in this RFP. Execution of the bid signature sheets in conjunction with any applicable statements concerning exceptions, when such statements have been made on the "Debarment Certification", constitutes the Proposer's certification of "status" under penalty of perjury under the laws of the United States.

SUBMISSION OF DESIGN-BUILD PROPOSAL

04/03/07

DB1 G55A

The Proposer's attention is directed that each Proposer's Design-Build Proposal shall comply with the following requirements in order for that Design-Build Proposal to be responsive and considered for award.

1. The Proposer shall be prequalified with the Department prior to submitting a Design-Build Proposal.
2. The Proposer shall deliver the Design-Build Proposal to the place indicated, and prior to the time indicated in this Request for Proposals.
3. The Design-Build Proposal documents shall be signed by an authorized employee of the Proposer.
4. The Design-Build Proposal shall be accompanied by Bid surety in the form of a Bid bond or Bid deposit.
5. If Disadvantaged Business Enterprises (DBE) goals are established for this contract, the Proposer shall complete the form Listing of DBE Subcontractors contained elsewhere in this RFP in accordance with the Project Special Provision entitled Disadvantaged Business Enterprises.
6. The Design-Build Proposal shall address all the requirements as specified in this Request for Proposals.

In addition to the above requirements, failure to comply with any of the requirements of Article 102-8 of the Standard Special Provisions, Division One (found elsewhere in this RFP) or Articles 102-10 or 102-11 of the 2006 *Standard Specifications for Roads and Structures* may result in a Design-Build Proposal being rejected.

CONFIDENTIAL QUESTIONS

(1-5-07)

DB1 G56

The Design-Build Team will be permitted to ask confidential questions of the Department, which neither the question nor answer will be shared with other proposing teams. For the purpose of this provision, “confidential question” is defined as a private inquiry containing information whose disclosure could alert others to certain details of doing business in a particular manner. The Department will determine if the question is considered a confidential question.

- I. Confidential questions arising prior to issuance of the Final Request for Proposals will be allowed at the External RFP review with the individual teams.

The Department will answer the confidential question verbally at the meeting if possible. If not answered verbally during the meeting, the Department will answer the confidential question by subtle changes in the Final Request for Proposals, which will clarify the scope by either allowing or disallowing the request. The revision will be made in such a manner as to not disclose the confidential question.

- II. After the issuance of the Final Request for Proposals, confidential questions may be asked by requesting a meeting with the Contract Officer. The request shall be in writing and provide sufficient detail to evaluate the magnitude of the request. Questions shall be of such

magnitude as to warrant a special meeting. Minor questions will not be acknowledged or answered.

After evaluation, the Contract Officer will respond to the question in writing to the Design-Build Team only. Other teams will not be notified of the question or answer.

If the Design-Build Team includes work based on the confidential questions and answers, the work shall be included and discussed in the Technical Proposal. The Technical Proposal will be evaluated in accordance with existing policies.

VALUE ANALYSIS

(1-5-07)

DB2 R12

Value Engineering Construction Proposals (VECP), as identified in Article 104-12 of 2006 *Standard Specifications for Roads and Structures* will be accepted. Only proposals, which alter the requirements of the RFP issued by the Department, will be considered as Value Engineering Construction Proposals.

SCHEDULE OF ESTIMATED COMPLETION PROGRESS

(07-15-08)

DB1 G58

The Design-Build Team's attention is directed to the Standard Special Provision entitled "Availability of Funds - Termination of Contracts" included elsewhere in this RFP. The Department of Transportation's schedule of estimated completion progress for this project as required by that Standard Special Provision is as follows:

<u>Fiscal Year</u>	<u>Progress (Dollar Value)</u>
2010 (07/01/09 – 06/30/10)	7% of Total Amount Bid
2011 (07/01/10 – 06/30/11)	43% of Total Amount Bid
2012 (07/01/11 – 06/30/12)	31% of Total Amount Bid
2013 (07/01/12 – 06/30/13)	19% of Total Amount Bid

The Design-Build Team shall also furnish its own progress schedule in accordance with Project Special Provision entitled "Progress Schedule" (found elsewhere in this RFP). Any acceleration of the progress as shown by the Design-Build Team's progress schedule over the progress as shown above shall be subject to the approval of the Engineer.

REVISION TO FHWA-1273 CONCERNING PERSONAL INFORMATION ON PAYROLL SUBMISSIONS:

(1-20-09)

DB1G59

Revise the *Standard Special Provision FHWA-1273 Required Contract Provisions Federal-Aid Construction Contracts* as follows:

Section V, Paragraph 2b is replaced with the following:

The payroll records shall contain the name, and the last four digits of the social security number of each such employee, his or her correct classification; hourly rates of wages paid (including rates of contributions or costs anticipated for bona fide fringe benefits or cash equivalent thereof the types described in Section 1(b)(2)(B) of the Davis Bacon Act); daily and weekly number of hours worked; deductions made; and actual wages paid.

DISADVANTAGED BUSINESS ENTERPRISE

(08-28-09)

DB1 G61

Policy

It is the policy of the North Carolina Department of Transportation that Disadvantaged Business Enterprises (DBEs) as defined in *49 CFR Part 26* shall have the equal opportunity to compete fairly for and to participate in the performance of contracts financed in whole or in part by Federal Funds.

Obligation

The Design-Build Team, subcontractor, and sub-recipient shall not discriminate on the basis of race, religion, color, national origin, age, disability or sex in the performance of this contract. The Design-Build Team shall comply with applicable requirements of *49 CFR Part 26* in the award and administration of federally assisted contracts. Failure by the Design-Build Team to comply with these requirements is a material breach of this contract, which may result in the termination of this contract or such other remedy, as the Department deems necessary.

Definitions

Commitment - The approved DBE participation submitted by the Design-Build Team during the bidding process.

Committed DBE - Any DBE listed on the DBE commitment list approved by the Department at the time of Price Proposal submission or any DBE utilized as a replacement for a DBE firm listed on the commitment list.

Department - North Carolina Department of Transportation

Disadvantaged Business Enterprise (DBE) – A firm certified as a Disadvantaged Business Enterprise through the North Carolina Unified Certification Program.

Goal - The DBE participation specified herein

Letter of Intent – Written documentation of the Design-Build Team’s commitment to use a DBE subcontractor and confirmation from the DBE that it is participating in the contract.

Manufacturer - A firm that operates or maintains a factory or establishment that produces on the premises the materials or supplies obtained by the Design-Build Team.

Regular Dealer - A firm that owns, operates, or maintains a store, warehouse, or other establishment in which the materials or supplies required for the performance of the contract are bought, kept in stock, and regularly sold to the public in the usual course of business. A regular dealer engages in, as its principal business and in its own name, the purchase and sale or lease of the products in question. A regular dealer in such bulk items as steel, cement, gravel, stone, and petroleum products need not keep such products in stock, if it owns or operates distribution equipment. Brokers and packagers are not regarded as manufacturers or regular dealers within the meaning of this section.

Form RS-1-D - Form for subcontracts involving DBE subcontractors attesting to the agreed upon unit prices and extensions for the affected contract items.

North Carolina Unified Certification Program - A program that provides comprehensive information to applicants for certification, such that an applicant is required to apply only once for a DBE certification that will be honored by all recipients of USDOT funds in the state and not limited to the Department of Transportation only. The Certification Program is in accordance with *49 CFR Part 26*.

USDOT - United States Department of Transportation, including the Office of the Secretary, the Federal Highway Administration (FHWA), the Federal Transit Administration (FTA), and the Federal Aviation Administration (FAA).

Contract Goal

The following goal for participation by Disadvantaged Business Enterprises is established for this contract:

Disadvantaged Business Enterprises **10 %**

- (A) *If the goal is more than zero*, the Design-Build Team shall exercise all necessary and reasonable steps to ensure that Disadvantaged Business Enterprises participate in at least the percent of the contract as set forth above as the goal.
- (B) *If the goal is zero*, the Design-Build Team shall continue to recruit the DBEs and report the use of DBEs during the construction of the project. A good faith effort will not be required with a zero goal.

This goal is to be met through utilization of highway construction contractors and / or right-of-way acquisition firms. Utilization of DBE firms performing design, other preconstruction services, or Construction Engineering and Inspection are not included in this goal.

Contract Requirement

The approved DBE participation submitted by the Design-Build Team shall be the **Contract Requirement**.

Certified Transportation Firms Directory

Real-time information about firms doing business with the Department and firms that are certified through North Carolina's Unified Certification Program is available in the Directory of Transportation Firms. The Directory can be accessed by the link on the Department's homepage or by entering <https://apps.dot.state.nc.us/vendor/directory/> in the address bar of your web browser. Only firms identified as DBE certified in the Directory can be utilized to meet the contract goals.

The listing of an individual firm in the Department's directory shall not be construed as an endorsement of the firm's capability to perform certain work.

Listing of DBE Subcontractors in Contract

Only those DBE firms with current certification are acceptable for listing in the Proposer's submittal of DBE participation. The Design-Build Team shall indicate the following required information:

- (1) *If the goal is more than zero*, Proposers at the time the Price Proposal is submitted, shall submit a listing of DBE participation on the appropriate form (or facsimile thereof) contained elsewhere in the RFP in order for the Price Proposal to be considered responsive. Proposers shall indicate the total dollar value of the DBE participation for the contract. If Proposers have no DBE participation, they shall indicate this on the form "Listing of DBE Subcontractors" by entering the word or number zero. This form shall be completed in its entirety. **Blank forms will not be deemed to represent zero participation.** Price Proposals submitted that do not have DBE participation indicated on the appropriate form will not be read publicly during the opening of Price Proposals. The Department will not consider these Price Proposals for award and the Price Proposal will be returned to the Proposer.
- (2) *If the goal is zero*, Proposers at the time the Price Proposal is submitted, the Proposer shall enter the word "zero" or number "0" or if there is participation, add the value on the "Listing of DBE Subcontractors" (or facsimile thereof) contained elsewhere in the RFP.

Written Documentation – Letter of Intent

The Proposer shall submit written documentation of the Proposer's commitment to use a DBE subcontractor whose participation it submits to meet a contract goal and written confirmation from each DBE, listed in the proposal, indicating their participation in the contract. This documentation shall be submitted on the Department's form titled "Letter of Intent to Perform as a Subcontractor". This letter of intent form is available at:

<http://www.ncdot.org/doh/preconstruct/ps/contracts/letterofintent.pdf>.

It shall be received in the office of the State Contractor Utilization Engineer no later than 12:00 noon of the sixth calendar day following opening of Price Proposals.

If the Proposer fails to submit the letter of intent from each committed DBE listed in the proposal indicating their participation in the contract, the DBE participation will not count toward meeting the goal.

Counting DBE Participation toward Meeting DBE Goal of Zero or More

- (A) If a firm is determined to be an eligible DBE firm, the total dollar value of the participation by the DBE will be counted toward the contract requirement. The total dollar value of participation by a certified DBE will be based upon the value of work actually performed by the DBE and the actual payments to DBE firms by the Design-Build Team.
- (B) When a DBE performs as a participant in a joint venture, the Design-Build Team may count toward its DBE goal a portion of the total value of participation with the DBE in the joint venture, that portion of the total dollar value being a distinct clearly defined portion of work that the DBE performs with its forces.
- (C)
 - (1) The Design-Build Team may count toward its DBE requirement only expenditures to DBEs that perform a commercially useful function in the work of a contract. A DBE performs a commercially useful function when it is responsible for execution of the work of the contract and is carrying out its responsibilities by actually performing, managing, and supervising the work involved. To perform a commercially useful function, the DBE shall also be responsible with respect to materials and supplies used on the contract, for negotiating price, determining quality and quantity, ordering the material and installing (where applicable) and paying for the material itself. To determine whether a DBE is performing a commercially useful function, the Department will evaluate the amount of work subcontracted, industry practices, whether the amount the firm is to be paid under the contract is commensurate with the work it is actually performing and the DBE credit claimed for its performance of the work, and other relevant factors.
 - (2) A DBE may enter into subcontracts. Work that a DBE subcontracts to another DBE firm may be counted toward the contract requirement. Work that a DBE subcontracts to a non-DBE firm does not count toward the contract requirement. If a DBE contractor or subcontractor subcontracts a significantly greater portion of the work of the contract than would be expected on the basis of standard industry practices, the DBE shall be presumed not to be performing a commercially useful function. The DBE may present evidence to rebut this presumption to the Department for commercially useful functions. The Department's decision on the rebuttal of this presumption is subject to review by the Federal Highway Administration but is not administratively appealable to USDOT.
 - (3) The following factors will be used to determine if a DBE trucking firm is performing a commercially useful function.

- (a) The DBE shall be responsible for the management and supervision of the entire trucking operation for which it is responsible on a particular contract, and there shall not be a contrived arrangement for the purpose of meeting DBE goals.
 - (b) The DBE shall itself own and operate at least one fully licensed, insured, and operational truck used on the contract.
 - (c) The DBE receives credit for the total value of the transportation services it provides on the contract using trucks it owns, insures, and operates using drivers it employs.
 - (d) The DBE may lease trucks from another DBE firm, including an owner-operator who is certified as a DBE. The DBE who leases trucks from another DBE receives credit for the total value of the transportation services the lessee DBE provides on the contract.
 - (e) The DBE may also lease trucks from a non-DBE firm, including from an owner-operator. The DBE who leases trucks from a non-DBE is entitled to credit for the total value of transportation services provided by non-DBE lessees not to exceed the value of transportation services provided by DBE-owned trucks on the contract. Additional participation by non-DBE lessees receives credit only for the fee or commission it receives as a result of the lease arrangement. The value of services performed under lease agreements between the DBE and Design-Build Team shall not count towards the contract requirement.
 - (f) For purposes of this paragraph, a lease shall indicate that the DBE has exclusive use of and control over the truck. This does not preclude the leased truck from working for others during the term of the lease with the consent of the DBE, so long as the lease gives the DBE absolute priority for use of the leased truck. Leased trucks shall display the name and identification number of the DBE.
- (D)** A Design-Build Team may count toward its DBE requirement 60 percent of its expenditures for materials and supplies required to complete the contract and obtained from DBE regular dealer and 100 percent of such expenditures to a DBE manufacturer.
- (E)** A Design-Build Team may count toward its DBE requirement the following expenditures to DBE firms that are not manufacturers or regular dealers:
- (1) The fees or commissions charged by a DBE firm for providing a bona fide service, such as professional, technical, consultant, or managerial services, or for providing bonds or insurance specifically required for the performance of a DOT-assisted contract, provided the fees or commissions are determined to be

reasonable and not excessive as compared with fees and commissions customarily allowed for similar services.

- (2) The fees or commissions charged for assistance in the procurement of the materials and supplies, or for transportation charges for the delivery of materials or supplies required on a job site (but not the cost of the materials and supplies themselves), provided the fees are not from a manufacturer or regular dealer and provided the fees are determined to be reasonable and not excessive as compared with fees customarily allowed for similar services.

Good Faith Effort for Projects with Goals More than Zero

If the DBE participation submitted in the Price Proposal by the Proposer with the apparent adjusted low price does not meet or exceed the DBE contract goal, this Proposer shall submit to the Department documentation of its good faith efforts made to reach the contract goal. One complete set and 9 copies of this information shall be received in the office of the State Contractor Utilization Engineer no later than 12:00 noon of the sixth calendar day following opening of Price Proposals. Where the information submitted includes repetitious solicitation letters it will be acceptable to submit a representative letter along with a distribution list of the firms that were solicited. Documentation of DBE quotations shall be a part of the good faith effort submittal as necessary to demonstrate compliance with the factors listed below which the Department considers in judging good faith efforts. This documentation may include written subcontractor quotations, telephone log notations of verbal quotations, or other types of quotation documentation.

The following factors will be used to determine if the Proposer has made adequate good faith effort:

- (A) Whether the Proposer attended any pre-bid meetings that were scheduled by the Department to inform DBEs of subcontracting opportunities.
- (B) Whether the Proposer provided solicitations through all reasonable and available means (e.g. advertising in newspapers owned and targeted to the Disadvantaged at least 10 calendar days prior to Price Proposal opening). Whether the Proposer provided written notice to all DBEs listed in the NCDOT Directory of Transportation Firms, within the Divisions and surrounding Divisions where the project is located, that specialize in the areas of work (as noted in the DBE Directory) that the Proposer will be subcontracting.
- (C) Whether the Proposer followed up initial solicitations of interests by contacting DBEs to determine with certainty whether they were interested. If a reasonable amount of DBEs within the targeted Divisions do not provide an intent to quote or no DBEs specialize in the subcontracted areas, the Proposer shall notify DBEs outside of the targeted Divisions that specialize in the subcontracted areas, and contact the Director of Business and Opportunity Workforce Development to give notification of the Proposer's inability to get DBE quotes.

- (D) Whether the Proposer selected portions of the work to be performed by DBEs in order to increase the likelihood of meeting the contract goals. This includes, where appropriate, breaking out contract work items into economically feasible units to facilitate DBE participation, even when the Proposer might otherwise perform these work items with its own forces.
- (E) Whether the Proposer provided interested DBEs with adequate and timely information about the plans, specifications and requirements of the contract.
- (F) Whether the Proposer negotiated in good faith with interested DBEs without rejecting them as unqualified without sound reasons based on a thorough investigation of their capabilities. Any rejection should be noted in writing with a description as to why an agreement could not be reached.
- (G) Whether quotations were received from interested DBE firms but rejected as unacceptable without sound reasons why the quotations were considered unacceptable. The fact that the DBE firms quotation for the work is not the lowest quotation received will not in itself be considered as a sound reason for rejecting the quotation as unacceptable. The fact that the Proposer has the ability and / or desire to perform the contract work with its own forces will not be considered as sound reason for rejecting a DBE quote. Nothing in this provision shall be construed to require the Proposer to accept unreasonable quotes in order to satisfy contract goals.
- (H) Whether the Proposer specifically negotiated with subcontractors to assume part of the responsibility to meet the contract DBE goal when the work to be sublet includes potential for DBE participation.
- (I) Whether the Proposer made any efforts and / or offered assistance to interested DBEs in obtaining the necessary equipment, supplies, materials, insurance, and / or bonding to satisfy the work requirements in the RFP.
- (J) Any other evidence that the Proposer submits which show that the Proposer has made reasonable good faith efforts to meet the contract goal.

If a Proposer is the Proposer with the apparent adjusted low price or apparent lowest responsive bidder on more than one project within the same letting located in the same geographic area of the state, as a part of the good faith effort the Department will consider allowing the Proposer to combine the DBE participation as long as the overall DBE goal value of the combined projects is achieved.

If the Department does not award the contract to the Proposer with the apparent adjusted low price, the Department reserves the right to award the contract to the Proposer with the next apparent adjusted low price that can satisfy the Department that the contract goal can be met or that adequate good faith efforts have been made to meet the goal.

DBE Replacement

The Design-Build Team shall not terminate a committed DBE subcontractor for convenience or perform the work with its own forces or those of an affiliate. If the Design-Build Team fails to demonstrate reasonable efforts to replace a committed DBE firm that does not perform as intended with another committed DBE firm or completes the work with its own forces without the Engineer's approval, the Design-Build Team and any of its affiliated companies may be disqualified from further bidding for a period of up to 6 months.

The Design-Build Team shall comply with the following for replacement of committed DBE.

(A) Performance Related Replacement

When a DBE is terminated or fails to complete its work on the contract for any reason, the Design-Build Team shall take all necessary, reasonable steps to replace the DBE subcontractor with another DBE subcontractor to perform at least the same amount of work as the DBE that was terminated. The Design-Build Team is encouraged to first attempt to find another DBE firm to do the same work as the DBE that was being terminated.

To demonstrate necessary, reasonable good faith efforts, the Design-Build Team shall document the steps they have taken to replace any DBE subcontractor who is unable to perform successfully with another DBE subcontractor. Such documentation shall include but not be limited to the following:

- (1) Copies of written notification to DBEs that their interest is solicited in subcontracting the work defaulted by the previous DBE subcontractor or in subcontracting other items of work in the contract.
- (2) Efforts to negotiate with DBEs for specific subbids including, at a minimum:
 - (a) The names, addresses, and telephone numbers of DBEs who were contacted.
 - (b) A description of the information provided to DBEs regarding the plans and specifications for portions of the work to be performed.
- (3) For each DBE contacted but rejected as unqualified, the reasons for the Design-Build Team's conclusion.
- (4) Efforts made to assist the DBEs contacted, if needed, in obtaining bonding or insurance required by the Design-Build Team.

(B) Decertification Replacement

- (1) When a committed DBE is decertified by the Department after a Request for Subcontract has been received by the Department, the Department will not require the Design-Build Team to solicit replacement DBE participation equal to the remaining work to be performed by the decertified firm. The participation equal to the remaining work performed by the decertified firm will count toward the contract requirement.
- (2) When a committed DBE is decertified prior to the Department receiving a Request for Subcontract for the named DBE firm, the Design-Build Team shall take all necessary and reasonable steps to replace the DBE subcontractor with another DBE subcontractor to perform at least the same amount of work to meet the contract goal or demonstrate that it has made a good faith effort to do so.

Changes in the Work

When the Engineer makes changes that result in the reduction or elimination of work to be performed by a committed DBE, the Design-Build Team will not be required to seek additional participation. When the Engineer makes changes that result in additional work to be performed by a DBE based upon the Design-Build Team's commitment, the DBE shall participate in additional work to the same extent as the DBE participated in the original contract work.

When the Engineer makes changes that result in extra work, which has more than a minimal impact on the contract amount, the Design-Build Team shall seek additional participation by DBEs unless otherwise approved by the Engineer.

When the Engineer makes changes that result in an alteration of plans or details of construction and a portion or all of work had been expected to be performed by a committed DBE, the Design-Build Team shall seek participation by DBEs unless otherwise approved by the Engineer.

When the Design-Build Team requests changes in the work that result in the reduction or elimination of work that the Design-Build Team committed to be performed by a DBE, the Design-Build Team shall seek additional participation by DBEs equal to the reduced DBE participation caused by the changes.

Reports

All requests for subcontracts involving DBE subcontractors shall be accompanied by a certification executed by both the Design-Build Team and the DBE subcontractor attesting to the agreed upon unit prices and extensions for the affected contract items. This information shall be submitted on the Department Form RS-1-D, located at:

<http://www.ncdot.org/doh/forms/files/FORMRS-1-D.doc>

unless otherwise approved by the Engineer. The Department reserves the right to require copies of actual subcontract agreements involving DBE subcontractors.

Within 30 calendar days of entering into an agreement with a DBE for materials, supplies or services, not otherwise documented by a Request for Subcontract as specified above, the Design-Build Team shall furnish the Engineer a copy of the agreement. The documentation should also indicate the percentage (60% or 100%) of expenditures claimed for DBE credit.

All certifications will be considered a part of the project records, and consequently will be subject to penalties under Federal Law associated with falsifications of records related to projects.

Reporting Disadvantaged Business Enterprise Participation

(A) The Design-Build Team shall provide the Engineer with an accounting of payments made to Disadvantaged Business Enterprise firms, including material suppliers, contractors at all levels (prime, subcontractor, or second tier subcontractor). This accounting shall be furnished to the Engineer for any given month by the end of the following month. Failure to submit this information accordingly may result in the following action:

- (1) Withholding of money due in the next partial pay estimate; or
- (2) Removal of any affiliated company of the Design-Build Team from the Department's appropriate prequalified list or the removal of other entities from the approved subcontractors list.

(B) The Design-Build Team shall report the accounting of payments through the Department's DBE Payment Tracking System, which is located at:

<https://apps.dot.state.nc.us/Vendor/PaymentTracking/>.

The Design-Build Team shall also provide the Engineer an affidavit attesting the accuracy of the information submitted in the Payment Tracking System. This too shall be submitted for any given month by the end of the following month.

(C) Design-Build Teams reporting transportation services provided by non-DBE lessees shall evaluate the value of services provided during the month of the reporting period only.

Prior to payment of the final estimate, the Design-Build Team shall furnish an accounting of total payment to each DBE. A responsible fiscal officer of the payee contractor, subcontractor, or second tier subcontractor who can attest to the date and amounts of the payments shall certify that the accounting is correct.

While each contractor (prime, subcontractor, 2nd tier subcontractor) is responsible for accurate accounting of payments to DBEs, it shall be the Design-Build Team's responsibility to report all monthly and final payment information in the correct reporting manner.

Failure on the part of the Design-Build Team to submit the required information in the time frame specified may result in the disqualification of that Design-Build Team and any of its affiliated companies from further bidding until the required information is submitted.

Failure on the part of any subcontractor to submit the required information in the time frame specified may result in the disqualification of that contractor and any affiliate companies from working on any DOT project until the required information is submitted.

Failure to Meet Contract Requirements

Failure to meet contract requirements in accordance with Article 102-16(J) of the *Standard Specifications* may be cause to disqualify the Design-Build Team.

CERTIFICATION FOR FEDERAL-AID CONTRACTS

(3-21-90)

DB1 G85

The Proposer certifies, by signing and submitting a Design-Build Proposal, to the best of his or her knowledge and belief, that:

- (1) No Federal appropriated funds have been paid or will be paid, by or on behalf of the undersigned, to any person for influencing or attempting to influence an officer or employee of any Federal agency, a Member of Congress, an officer or employee of Congress, or an employee of a Member of Congress in connection with the awarding of any Federal contract, the making of any Federal grant, the making of any Federal loan, the entering into of any cooperative agreement, and the extension, continuation, renewal, amendment, or modification of any Federal contract, grant, loan, or cooperative agreement.
- (2) If any funds other than Federal appropriated funds have been paid or will be paid to any person for influencing or attempting to influence an officer or employee of any Federal agency, a Member of Congress, an officer or employee of Congress, or an employee of a Member of Congress in connection with this Federal contract, grant, loan, or cooperative agreement, the undersigned shall complete and submit Standard Form-LLL, *Disclosure Form to Report Lobbying*, in accordance with its instructions.

This certification is a material representation of fact upon which reliance was placed when this transaction was made or entered into. Submission of this certification is a prerequisite for making or entering into this transaction imposed by *Section 1352, Title 31, U.S. Code*. Any person who fails to file the required certification shall be subject to a civil penalty of not less than \$10,000 and not more than \$100,000 for each such failure.

The Proposer also agrees by submitting a Design-Build Proposal that he or she shall require that the language of this certification be included in all lower tier subcontracts, which exceed \$100,000 and that all such sub-recipients shall certify and disclose accordingly.

REQUIRED CONTRACT PROVISIONS FOR ARRA

(3-17-09) (Rev 3-31-09)

DB1 G86

Reporting Requirements

The Contractor is hereby notified that this project will be financed with *American Recovery and Reinvestment Act of 2009 (ARRA)* Funds. The Contractor shall assure that all subcontracts, and

other contracts for services for an ARRA funded project shall also have these provisions in their contracts. As such the Department may require that the Contractor provide reports and other employment information as evidence to document the number of jobs created and/or sustained by this project for the Contractor's own workforce and any sub-contractors. No direct payment will be made for providing said reports as the cost for same shall be included in the various items in the contract.

Posting with the Local Employment Security Commission

In addition to any other job postings the Contractor normally utilizes, the Contractor shall post with the local Employment Security Commission Office, all positions for which he intends to hire workers as a result of being awarded this contract.

Required Contract Provision to Implement ARRA Section 902

Section 902 of the American Recovery and Reinvestment Act (ARRA) of 2009 requires that each contract awarded using ARRA funds must include a provision that provides the U.S. Comptroller General and his representatives with the authority to:

- (1) Examine any records of the contractor or any of its subcontractors, or any State or local agency administering such contract, that directly pertain to, and involve transactions relating to, the contract or subcontract; and
- (2) Interview any officer or employee of the contractor or any of its subcontractors, or of any State or local government agency administering the contract, regarding such transactions.

Accordingly, the Comptroller General and his representatives shall have the authority and rights as provided under Section 902 of the ARRA with respect to this contract, which is funded with funds made available under the ARRA. Section 902 further states that nothing in this section shall be interpreted to limit or restrict in any way any existing authority of the Comptroller General.

Authority of the Inspector General

Section 1515(a) of the ARRA provides authority for any representatives of the Inspector General to examine any records or interview any employee or officers working on this contract. The contractor is advised that representatives of the inspector general have the authority to examine any record and interview any employee or officer of the contractor, its subcontractors or other firms working on this contract. Section 1515(b) further provides that nothing in this section shall be interpreted to limit or restrict in any way any existing authority of an inspector general.

CONTRACTOR'S LICENSE REQUIREMENTS

(7-1-95)

DB1 G88

If the Design-Build Team does not hold the proper license to perform any plumbing, heating, air conditioning, or electrical work in this contract, he will be required to sublet such work to a contractor properly licensed in accordance with *Article 2 of Chapter 87 of the General Statutes*

(licensing of heating, plumbing, and air conditioning contractors) and *Article 4 of Chapter 87 of the General Statutes* (licensing of electrical contractors).

U.S. DEPARTMENT OF TRANSPORTATION HOTLINE

(11-22-94)

DB1 G100

To report bid rigging activities call: **1-800-424-9071**

The U.S. Department of Transportation (DOT) operates the above toll-free *hotline* Monday through Friday, 8:00 a.m. to 5:00 p.m. eastern time. Anyone with knowledge of possible bid rigging, bidder collusion, or other fraudulent activities should use the *hotline* to report such activities.

The *hotline* is part of the DOT's continuing effort to identify and investigate highway construction contract fraud and abuse. It is operated under the direction of the DOT Inspector General. All information will be treated confidentially and caller anonymity will be respected.

SUBSURFACE INFORMATION

(3-22-07)

DB1 G119

Available subsurface information will be provided on this project. The Design-Build Team shall be responsible for additional investigations and for verifying the accuracy of the subsurface information supplied by the Department.

BID DOCUMENTATION

(7/18/06)

DB1 G142

General

The successful Design-Build Team shall submit the original, unaltered bid documentation or a certified copy of the original, unaltered bid documentation used to prepare the Price Proposal for this contract to the Department. Such documentation shall be placed in escrow with a banking institution or other bonded document storage facility selected by the Department and preserved by that institution or facility as specified in the following sections of this provision.

Bid Documentation

The terms "bid documentation" as used in this provision means all written information, working papers, computer printouts and electronic media, charts, and all other data compilations which contain or reflect information, data, and calculations used by the Proposer in the preparation of their Price Proposal. The term "bid documentation" includes, but is not limited to, Design-Build Team equipment rates, Design-Build Team overhead rates, labor rates, efficiency or productivity factors, arithmetical calculations, and quotations from subcontractors and material suppliers to the extent that such rates and quotations were used by the Proposer in formulating and determining the Price Proposal. The term "bid documentation" also includes any manuals, which are standard to the industry used by the Proposer in determining the Price Proposal. Such manuals may be included in the bid documentation by reference. Such reference shall include

the name and date of the publication and the publisher. The term does not include bid documents provided by the Department for use by the Proposer in bidding on this project.

Submittal of Bid Documentation

A representative of the Proposer shall deliver the original, unaltered bid documentation or a certified copy of the original, unaltered bid documentation to the Department, in a container suitable for sealing, within ten (10) days after the notice of award is received by the Proposer. Bid documentation will be considered a certified copy if the Proposer includes a letter to the Department from a chief officer of the company stating that the enclosed documentation is an EXACT copy of the original documentation. The letter must be signed by a chief officer of the company, have the person's name and title typed below the signature, and the signature shall be notarized at the bottom of the letter. The Department will not execute the contract until the original, unaltered bid documentation or a certified copy of the original, unaltered bid documentation has been received by the Department. The container shall be clearly marked "Bid Documentation" and shall also show on the face of the container the Proposer's name, Proposer's address, the date of submittal, the Project Number, and the County.

Affidavit

In addition to the bid documentation, an affidavit signed under oath by an individual authorized by the Proposer to execute the bid shall be included. The affidavit shall list each bid document with sufficient specificity so a comparison may be made between the list and the bid documentation to ensure that all of the bid documentation listed in the affidavit has been enclosed. The affidavit shall attest that the affiant has personally examined the bid documentation, that the affidavit lists all of the documents used by the Proposer to determine the Price Proposal for this project, and that all such bid documentation has been included.

Verification

Upon delivery of the bid documentation, the Department's Contract Officer and the Proposer's representative will verify the accuracy and completeness of the bid documentation compared to the affidavit. Should a discrepancy exist, the Proposer's representative shall immediately furnish the Department's Contract Officer with any other needed bid documentation. The Department's Contract Officer upon determining that the bid documentation is complete will, in the presence of the Proposer's representative, immediately place the complete bid documentation and affidavit in the container and seal it. Both parties will deliver the sealed container to a banking institution or other bonded document storage facility selected by the Department for placement in a safety deposit box, vault, or other secure accommodation.

Duration and Use

The bid documentation and affidavit shall remain in escrow until 60 calendar days from the time the Design-Build Team receives the final estimate; or until such time as the Design-Build Team gives written notice of intent to file a claim, files a written claim, files a written and verified claim, or initiates litigation against the Department related to the contract; or until authorized in

writing by the Design-Build Team. Upon the giving of written notice of intent to file a claim, filing a written claim, filing a written and verified claim, or the initiation of litigation by the Design-Build Team against the Department, or receipt of a letter from the Design-Build Team authorizing release, the Department may obtain the release and custody of the bid documentation. If the bid documentation remains in escrow 60 calendar days after the time the Design-Build Team receives the final estimate and the Design-Build Team has not filed a written claim, filed a written and verified claim, or has not initiated litigation against the Department related to the contract, the Department shall instruct the banking institution or other bonded document storage facility to release the sealed container to the Design-Build Team.

The Proposer certifies and agrees that the sealed container placed in escrow contains all of the bid documentation used to determine the Price Proposal and that no other bid documentation shall be relevant or material in litigation over claims brought by the Design-Build Team arising out of this contract.

Failure to Provide Bid Documentation

The Proposer's failure to provide the original, unaltered bid documentation or a certified copy of the original, unaltered bid documentation within 10 days after the notice of award is received by the Proposer may be just cause for rescinding the award of the contract and may result in the removal of the Proposer from the Department's appropriate prequalified list for a period up to 180 days. Award may then be made to the Proposer with the next lowest adjusted price or the work may be readvertised and constructed under the contract or otherwise, as the Board of Transportation may decide.

Escrow Agreement

The Proposer will be required to sign an Escrow Agreement within 10 days after the Proposer receives the notice of award. A copy of this Escrow Agreement document will be mailed to the Proposer with the notice of award for informational purposes. The Proposer and Department will sign the Escrow Agreement at the time that the bid documentation is delivered to a Banking Institution or other facility as outlined above. The Proposer's failure to sign the Escrow Agreement at the time the bid documentation is delivered may be just cause for rescinding the award of the contract and may result in the removal of the Proposer from the Department's appropriate prequalified list for a period up to 180 days. Award may then be made to the Proposer with the next lowest adjusted price or the work may be readvertised and constructed under the contract or otherwise, as the Board of Transportation may decide.

Confidentiality of Bid Documentation

The bid documentation and affidavit in escrow are, and will remain, the property of the Proposer. The Department has no interest in, or right to, the bid documentation and affidavit other than to verify the contents and legibility of the bid documentation unless the Design-Build Team gives written notice of intent to file a claim, files a written claim, files a written and verified claim, or initiates litigation against the Department. In the event of such written notice of intent to file a claim, filing of a written claim, filing a written and verified claim, or initiation of litigation

against the Department, or receipt of a letter from the Design-Build Team authorizing release, the bid documentation and affidavit may become the property of the Department for use in considering any claim or in litigation as the Department may deem appropriate.

Any portion or portions of the bid documentation designated by the Proposer as a "trade secret" at the time the bid documentation is delivered to the Department's Contract Officer shall be protected from disclosure as provided by G.S. 132-1.2.

Cost and Escrow Instructions

The cost of the escrow will be borne by the Department. The Department will provide escrow instructions to the banking institution or other bonded document storage facility consistent with this provision.

There will be no separate payment for all costs of compilation of the data, container, or verification of the bid documentation. Payment at the lump sum price for the Design-Build project will be full compensation for all such costs.

TWELVE MONTH GUARANTEE

(7-15-03)

DB1 G145

- (A) The Design-Build Team shall guarantee materials and workmanship against latent and patent defects arising from faulty materials, faulty workmanship or negligence for a period of twelve months following the date of final acceptance of the work for maintenance and shall replace such defective materials and workmanship without cost to the Department. The Design-Build Team will not be responsible for damage due to faulty design, normal wear and tear, for negligence on the part of the Department, and/or for use in excess of the design.
- (B) Where items of equipment or material carry a manufacturer's guarantee for any period in excess of twelve months, then the manufacturer's guarantee shall apply for that particular piece of equipment or material. The Department's first remedy shall be through the manufacturer although the Design-Build Team shall be responsible for invoking the warranted repair work with the manufacturer. The Design-Build Team's responsibility shall be limited to the term of the manufacturer's guarantee. NCDOT would be afforded the same warranty as provided by the Manufacturer.
- (C) The Design-Build Team shall be responsible for any and all remediation activities at the on-site wetland mitigation sites for a period of twelve months following final acceptance of the project at no additional cost to the Department.

This guarantee provision shall be invoked only for major components of work in which the Design-Build Team would be wholly responsible for under the terms of the contract. Examples would include pavement structures, bridge components, on-site mitigation and sign structures. This provision will not be used as a mechanism to force the Design-Build Team to return to the project to make repairs or perform additional work that the Department would normally

compensate the Design-Build Team for. In addition, routine maintenance activities (i.e. mowing grass, debris removal, ruts in earth shoulders,) are not parts of this guarantee.

Appropriate provisions of the payment and/or performance bonds shall cover this guarantee for the project. In addition, failure on the part of the responsible entity(ies) of the Design-Build Team to perform guarantee work within the terms of this provision shall be just cause to remove the responsible entity(ies) from the Department's corresponding prequalified list. The Design-Build Team will be removed for a minimum of 6 months and will be reinstated only after all work has been corrected and the Design-Build Team requests reinstatement in writing.

To ensure uniform application statewide the Division Engineer will forward details regarding the circumstances surrounding any proposed guarantee repairs to the Chief Engineer for review and approval prior to the work being performed.

OUTSOURCING OUTSIDE THE USA

(5-16-06)

DB1 G150

All work on consultant contracts, services contracts, and construction contracts shall be performed in the United States of America. No work shall be outsourced outside of the United States of America.

Outsourcing for the purpose of this provision is defined as the practice of subcontracting labor, work, services, staffing, or personnel to entities located outside of the United States.

The North Carolina Secretary of Transportation shall approve exceptions to this provision in writing.

CLEARING AND GRUBBING

(01-22-08)

DB8 R01

Perform clearing on this project to the limits established by Method "III" shown on Standard No. 200.03 of the 2006 *NCDOT Roadway Standard Drawings*.

Revise the 2006 *Standard Specifications for Roads and Structures* as follows:

Page 2-2, Article 200-3, Clearing, add the following as the 6th paragraph:

At bridge sites, clear the entire width of the right of way beginning at a station 3 feet back of the beginning extremity of the structure and ending at a station 3 feet beyond the ending extremity of the structure.

SHPO DOCUMENTATION FOR BORROW/WASTE SITES

(12-18-07)

DB8 R02

Revise the 2006 *Standard Specifications for Roads and Structures* as follows:

Division 2 Earthwork

Page 2-16, Subarticle 230-1(D), add the words: *The Contractor specifically waives* as the first words of the sentence.

Page 2-17, Subarticle 230-4(B) Contractor Furnished Sources, first paragraph, first sentence replace with the following:

Prior to the approval of any borrow sources developed for use on any project, obtain certification from the State Historic Preservation Officer of the State Department of Cultural Resources certifying that the removal of the borrow material from the borrow sources(s) will have no effect on any known district, site building, structure, or object, architectural and / or archaeological that is included or eligible for inclusion in the National Register of Historic Places.

Division 8 Incidentals

Page 8-9, Article 802-2 General Requirements, add the following as the 1st paragraph:

Prior to the removal of any waste from any project, obtain certification from the State Historic Preservation Officer of the State Department of Cultural Resources certifying that the deposition of the waste material to the proposed waste area will have no effect on any known district, site building, structure, or object, architectural and / or archaeological that is included or eligible for inclusion in the National Register of Historic Places. Furnish a copy of this certification to the Engineer prior to performing any work in the proposed waste site.

Page 8-10, Article 802-2, General Requirements, 4th paragraph, add the following as the 2nd sentence:

The Department's borrow and waste site reclamation procedures for contracted projects is available on the NCDOT website and shall be used for all borrow and waste sites on this project.

EROSION & SEDIMENT CONTROL/STORMWATER CERTIFICATION

1-16-07 (Rev 1-15-08) (DB Rev. 12/05/07)

DB1 G180

General

Schedule and conduct construction activities in a manner that will minimize soil erosion and the resulting sedimentation and turbidity of surface waters. Comply with the requirements herein regardless of whether or not a National Pollutant Discharge Elimination System (NPDES) permit for the work is required.

Establish a chain of responsibility for operations and subcontractors' operations to ensure that the *Erosion and Sediment Control / Stormwater Pollution Prevention Plan* is implemented and maintained over the life of the contract.

- (A) *Certified Supervisor* – Provide a certified Erosion and Sediment Control / Stormwater (E&SC/SW) Supervisor to manage the Design-Build Team and subcontractor(s) operations, ensure compliance with Federal, State and Local ordinances and regulations, and to manage the Quality Control Program.
- (B) *Certified Foreman* – Provide a certified, trained foreman for each construction operation that increases the potential for soil erosion or the possible sedimentation and turbidity of surface waters.
- (C) *Certified Installer* – Provide a certified installer to install or direct the installation for erosion and sediment control / stormwater practices.
- (D) *Certified Designer* – Provide a certified designer for the design of the erosion and sediment control / stormwater component of reclamation plans and, if applicable, for the design of the project erosion and sediment control / stormwater plan.

In the case of difference of opinion or interpretation of plan or contract requirements between the Design-Build Team and the Engineer, the Engineer's determination and decision will be final.

Roles and Responsibilities

- (A) *Certified Supervisor* - The Certified Supervisor shall be responsible for ensuring erosion and sediment control / stormwater is adequately implemented and maintained on the project and conducting the quality control program. The Certified Supervisor shall be on the project within 24 hours from initial exposure of an erodible surface to the project's final acceptance when questions or concerns arise with erosion and sedimentation control / stormwater issues. Perform the following duties:
 - (1)
 - (a) Manage Operations - Coordinate and schedule the work of subcontractors so that erosion and sediment control / stormwater measures are fully executed for each operation and in a timely manner over the duration of the contract.
 - (b) Oversee the work of subcontractors so that appropriate erosion and sediment control / stormwater preventive measures are conformed to at each stage of the work.
 - (c) Prepare the required weekly erosion control punchlist and submit to the Engineer.
 - (d) Attend all weekly or monthly construction meetings to discuss the findings of the NPDES inspection and other related issues.
 - (e) Implement the erosion and sediment control / stormwater site plans requested.
 - (f) Provide for erosion and sediment control / stormwater methods for the Design-Build Team's temporary work not shown on the plans, such as, but

- not limited to work platforms, temporary construction, pumping operations, plant and storage yards, and cofferdams.
- (g) Acquire applicable permits and comply with requirements for borrow pits, dewatering, and any temporary work conducted by the Design-Build Team in jurisdictional areas.
 - (h) Conduct all erosion and sediment control / stormwater work in a timely and workmanlike manner.
 - (i) Fully install erosion and sediment control / stormwater work prior to suspension of the work.
 - (j) Coordinate with Department, Federal, State and Local Regulatory agencies on resolution of erosion and sediment control / stormwater issues due to the Design-Build Team's operations.
 - (k) Ensure that proper cleanup occurs from vehicle tracking on paved surfaces and / or any location where sediment leaves the Right-of-Way.
 - (l) Have available a set of erosion control plans that has been properly updated to reflect necessary plan and field changes for use and review by Department personnel as well as regulatory agencies.
- (2) Requirements set forth under the NPDES Permit – The Department's NPDES permit outlines certain objectives and management measures pertaining to construction activities. The permit references *NCG010000, General Permit to Discharge Stormwater* under the NPDES, and states that the Department shall incorporate the applicable requirements into its delegated Erosion and Sediment Control Program. Some of the requirements are, but are not limited to:
- (a) Control project site waste to prevent contamination of surface or ground waters of the state (i.e. construction materials, concrete washout, chemicals, litter, fuels, lubricants, coolants, hydraulic fluids, any other petroleum products, and sanitary waste).
 - (b) Inspect erosion and sediment control / stormwater devices at least once every 7 calendar days, twice weekly for 303(d) impaired streams, and within 24 hours after a significant rainfall event of 0.5 inches within 24 hours.
 - (c) Maintain an onsite rain gauge and a record of rainfall amounts and dates.
 - (d) Maintain erosion and sediment control / stormwater inspection records for review by Department and Regulatory personnel upon request.
 - (e) Implement approved reclamation plans on all borrow pits and waste sites.
 - (f) Maintain a log of turbidity test results as outlined in the Department's Procedure for Monitoring Borrow Pit Discharge.
 - (g) Provide secondary containment for bulk storage of liquid materials.
 - (h) Provide training for employees concerning general erosion and sediment control / stormwater awareness, the NPDES Permit requirements, and the requirements of the *General Permit, NCG010000*.
 - (i) Report violations of the NPDES permit to the Engineer who will notify the DWQ Regional Office within 24 hours.

- (3) Quality Control Program - Maintain a quality control program to control erosion, prevent sedimentation and follow provisions of permits. The quality control program shall:
- (a) Follow permit requirements related to the Design-Build Team and subcontractors' construction activities.
 - (b) Ensure that all operators and / or subcontractor(s) on site have the proper erosion and sediment control / stormwater certification.
 - (c) Notify the Engineer when the required certified erosion and sediment control / stormwater personnel are not available on the job site when needed.
 - (d) Conduct the inspections required by the NPDES permit.
 - (e) Take corrective actions in the proper timeframe as required by the NPDES permit for problem areas identified during the NPDES inspections.
 - (f) Incorporate erosion control into the work in a timely manner and stabilize disturbed areas with mulch / seed or vegetative cover on a section-by-section basis.
 - (g) Maintain temporary erosion and sediment control devices.
 - (h) Remove temporary erosion or sediment control devices when they are no longer necessary as agreed upon by the Engineer.
 - (i) The Design-Build Team's quality control and inspection procedures shall be subject to review by the Engineer. Maintain NPDES inspection records and make records available at all times for verification by the Engineer.
- (B) *Certified Foreman* - At least one Certified Foreman shall be onsite for each type of work listed herein during the respective construction activities to control erosion, prevent sedimentation and follow permit provisions:
- (1) Foreman in charge of grading activities
 - (2) Foreman in charge of bridge or culvert construction over jurisdictional areas
 - (3) Foreman in charge of utility activities

The Design-Build Team may request to use the same person as the Level II Supervisor and Level II Foreman. This person shall be onsite whenever construction activities as described above are taking place. This request shall be approved by the Engineer prior to work beginning.

The Design-Build Team may request to name a single Level II Foreman to oversee multiple construction activities on small bridge or culvert replacement projects. This request shall be approved by the Engineer prior to work beginning.

- (C) *Certified Installers* - Provide at least one onsite, Level I Certified Installer for each of the following erosion and sediment control / stormwater crew:
- (1) Seeding and Mulching
 - (2) Temporary Seeding

- (3) Temporary Mulching
- (4) Sodding
- (5) Silt fence or other perimeter erosion / sediment control device installations
- (6) Erosion control blanket installation
- (7) Hydraulic tackifier installation
- (8) Turbidity curtain installation
- (9) Rock ditch check / sediment dam installation
- (10) Ditch liner / matting installation
- (11) Inlet protection
- (12) Riprap placement
- (13) Stormwater BMP installations (such as but not limited to level spreaders, retention / detention devices)
- (14) Pipe installations within jurisdictional areas

If a *Certified Installer* is not onsite, the Design-Build Team may substitute a Level I Installer with a Level II Foreman, provided the Level II Foreman is not tasked to another crew requiring Level II Foreman oversight.

- (D) *Certified Designer* – Include the certification number of the Level III-B Certified Designer on the erosion and sediment control / stormwater component of all reclamation plans and if applicable, the certification number of the Level III-A Certified Designer on the design of the project erosion and sediment control / stormwater plan.

Preconstruction Meeting

Furnish the names of the *Certified Supervisor, Certified Foremen, Certified Installers and Certified Designers* and notify the Engineer in writing of changes in certified personnel over the life of the contract within 2 days of change.

Ethical Responsibility

Any company performing work for the North Carolina Department of Transportation has the ethical responsibility to fully disclose any reprimand or dismissal of an employee resulting from improper testing or falsification of records.

Revocation or Suspension of Certification

Upon recommendation of the Chief Engineer - Operations to the certification entity, certification for Supervisor, Certified Foreman, Certified Installer and Certified Designer may be revoked or suspended with the issuance of a Continuing Immediate Corrective Action (Continuing ICA), Notice of Violation (NOV), or Cease and Desist Order for erosion and sediment control / stormwater related issues.

Should any of the following circumstances occur, the Chief Engineer may suspend or permanently revoke such certification.

- (A) Failure to adequately perform the duties as defined within the certification program
- (B) Issuance of a Continuing ICA, NOV, or Cease and Desist Order
- (C) Failure to fully perform environmental commitments as detailed within the permit conditions and specifications
- (D) Demonstration of erroneous documentation or reporting techniques
- (E) Cheating or copying another candidate's work on an examination
- (F) Intentional falsification of records
- (G) Directing a subordinate under direct or indirect supervision to perform any of the above actions
- (H) Dismissal from a company for any of the above reasons
- (I) Suspension or revocation of one's certification within another state

Suspension or revocation of a certification will be sent by certified mail to the registrant and the Corporate Head of the company that employs the registrant.

A registrant has the right to appeal any adverse action which results in suspension or permanent revocation of certification by responding, in writing, to the Chief Engineer within 10 calendar days after receiving notice of the proposed adverse action.

Chief Engineer - Operations
1537 Mail Service Center
Raleigh, NC 27699-1537

Failure to appeal within 10 calendar days will result in the proposed adverse action becoming effective on the date specified on the certified notice. Failure to appeal within the time specified will result in a waiver of all future appeal rights regarding the adverse action taken. The registrant will not be allowed to perform duties associated with the certification during the appeal process.

The Chief Engineer will hear the appeal and make a decision within 7 days of hearing the appeal. The decision of the Chief Engineer will be final and will be made in writing to the registrant.

If a certification is temporarily suspended, the registrant shall pass any applicable written examination and any proficiency examination, at the conclusion of the specified suspension period, prior to having the certification reinstated.

Measurement and Payment

Certified Supervisor, Certified Foremen, Certified Installers and Certified Designer will be incidental to the project for which no direct compensation will be made.

PROCEDURE FOR MONITORING BORROW PIT DISCHARGE

(2-20-07)

DB1 G181

Water discharge from borrow pit sites shall not cause surface waters to exceed 50 NTUs (nephelometric turbidity unit) in streams not designated as trout waters and 10 NTUs in streams, lakes or reservoirs designated as trout waters. For lakes and reservoirs not designated as trout waters, the turbidity shall not exceed 25 NTUs. If the turbidity exceeds these levels due to natural background conditions, the existing turbidity level shall not be increased.

If during any operating day, the downstream water quality exceeds the standard, the Design-Build Team shall do all of the following:

- (A) Either cease discharge or modify the discharge volume or turbidity levels to bring the downstream turbidity levels into compliance, or
- (B) Evaluate the upstream conditions to determine if the exceedance of the standard is due to natural background conditions. If the background turbidity measurements exceed the standard, operation of the pit and discharge can continue as long as the stream turbidity levels are not increased due to the discharge.
- (C) Measure and record the turbidity test results (time, date and sampler) at all defined sampling locations 30 minutes after startup and at a minimum, one additional sampling of all sampling locations during that 24-hour period in which the borrow pit is discharging.
- (D) Notify DWQ within 24 hours of any stream turbidity standard exceedances that are not brought into compliance.

During the Environmental Assessment required by Article 230-4 of the *Standard Specifications*, the Design-Build Team shall define the point at which the discharge enters into the State's surface waters and the appropriate sampling locations. Sampling locations shall include points upstream and downstream from the point at which the discharge enters these waters. Upstream sampling location shall be located so that it is not influenced by backwater conditions and represents natural background conditions. Downstream sampling location shall be located at the point where complete mixing of the discharge and receiving water has occurred.

The discharge shall be closely monitored when water from the dewatering activities is introduced into jurisdictional wetlands. Any time visible sedimentation (deposition of sediment) on the wetland surface is observed, the dewatering activity shall be suspended until turbidity levels in the stilling basin can be reduced to a level where sediment deposition does not occur. Staining of wetland surfaces from suspended clay particles, occurring after evaporation or infiltration, does not constitute sedimentation. No activities shall occur in wetlands that adversely affect the functioning of a wetland. Visible sedimentation shall be considered an indication of possible adverse impacts on wetland use.

The Engineer shall perform independent turbidity tests on a random basis. These results shall be maintained in a log within the project records. Records will include, at a minimum, turbidity test results, time, date and name of sampler. Should the Department's test results exceed those of the

Design-Build Team's test results, an immediate test shall be performed jointly with the results superseding the previous test results of both the Department and the Design-Build Team.

The Design-Build Team shall use the *NCDOT Turbidity Reduction Options for Borrow Pits Matrix*, available at <http://www.ncdot.org/doh/preconstruct/ps/contracts/letting.html> to plan, design, construct, and maintain BMPs to address water quality standards. Tier I Methods include stilling basins which are standard compensatory BMPs. Other Tier I methods are noncompensatory and shall be used when needed to meet the stream turbidity standards. Tier II Methods are also noncompensatory and are options that may be needed for protection of rare or unique resources or where special environmental conditions exist at the site which have led to additional requirements being placed in the DWQ's 401 Certifications and approval letters, Isolated Wetland Permits, Riparian Buffer Authorization or a DOT Reclamation Plan's Environmental Assessment for the specific site. Should the Design-Build Team exhaust all Tier I Methods on a site exclusive of rare or unique resources or special environmental conditions, Tier II Methods may be required by regulators on a case by case basis per supplemental agreement.

The Design-Build Team may use cation exchange capacity (CEC) values from proposed site borings to plan and develop the Price Proposal for the project. CEC values exceeding 15 milliequivalents per 100 grams of soil may indicate a high potential for turbidity and should be avoided when dewatering into surface water is proposed.

No additional compensation for monitoring borrow pit discharge will be paid.

REINFORCED CONCRETE PIPE DESIGN

(10-20-09)

DB3 R006

DESCRIPTION

This work consists of the design and manufacture of reinforced concrete pipes which require fills greater than 40 feet and less than or equal to 80 feet.

MATERIALS

(A) Design

When the design of a reinforced concrete pipe is required on the plans developed by the Design-Build Team, design the reinforced concrete pipe in accordance with the current edition of the AASHTO LRFD Bridge Design Specifications. Provide the diameter of pipe as indicated on the plans developed by the Design-Build Team and manufacture the pipe in accordance with ASTM C 1417. Provide a reinforced concrete pipe that meets the requirements of Section 1032-9, Section 1077 and any other applicable parts of the 2006 *Standard Specifications for Roads and Structures*.

The design of the reinforced concrete pipe shall be the Design-Build Team's responsibility and is subject to review, comments and approval. Submit two sets of detailed plans for review and acceptance. Include all details in the plans, including the size and spacing of the required reinforcement necessary to fabricate the reinforced

concrete pipe. Include checked design calculations for the reinforced concrete pipe. Have a North Carolina Registered Professional Engineer seal the plans and design calculations. After the plans are reviewed and , if necessary, all corrections made, submit one set of reproducible tracings on 22" * 34" sheets to become part of the plans developed by the Design-Build Team.

(B) Reinforced Concrete Pipe Sections

(1) Class

Reinforced concrete pipe sections manufactured in accordance with this Special Provision are designated by inside pipe diameter and design earth cover.

(2) Design Criteria

The design of the reinforced concrete pipe shall be in accordance with Article 12.10.4.2 "Direct Design Method" of the current edition of the AASHTO LRFD Bridge Design Specifications. The following assumptions shall be used in the design calculations:

NCDOT Criteria for Direct Design Method
Process and Material Factors
Radial Tension, $F_{rp}=1.0$
Shear Strength, $F_{vp}=1.0$
Design Concrete Strength - f'_c
$5,000 \text{ psi} < f'_c < 7,000 \text{ psi}$
Heger Pressure Distribution - Type 2 Installation
Vertical Arching Factor = 1.40
Horizontal Arching Factor = 0.40
Soil Unit Weight = $120 \text{ lb} / \text{ft}^3$
Depth of Fluid = Inside Pipe Diameter
Minimum Concrete Cover = 1.00"
Crack Control = 0.90 (maximum)

(C) Joints

Produce the reinforced concrete pipe sections with spigot and bell ends. Design and form the ends of the pipe section so, when the sections are laid together, they make a continuous line of pipe with a smooth interior free of appreciable irregularities in the flow line, and compatible with the permissible variations given in the 2006 *Standard Specifications for Roads and Structures* and ASTM C 1417.

(D) Manufacture

In addition to the requirements of the 2006 *Standard Specifications for Roads and Structures* and ASTM C 1417, devices or holes are permitted in each pipe section for the purpose of handling and placement. Submit details of handling devices or holes for approval and do not cast any

concrete until approval is granted. Remove all handling devices flush with concrete surfaces as directed. Fill holes in a neat and workmanlike manner with an approved non-metallic non-shrink grout, concrete or plug.

CULVERT PIPE

(1-19-10)

DB10R32

Revise the 2006 *Standard Specifications for Roads and Structures* as follows:

Page 10-67, Article 1032-1, replace (A), (B), (C), (E) and (F) with the following:

- (A) Coated corrugated metal culvert pipe and pipe arches.
- (B) Coated corrugated metal end sections, coupling band and other accessories
- (C) Corrugated aluminum alloy structural plate pipe and pipe arches
- (D) Corrugated aluminum alloy end sections, coupling band and other accessories
- (E) Welded steel pipe

Page 10-69, Subarticle 1032-3(A)(5) Coating Repair, replace with the following:

Repair shall be in accordance with Section 1076-6 of the 2006 *Standard Specifications for Roads and Structures*.

Subarticle 1032-3(A)(7) Aluminized Pipe, replace with the following:

Aluminized pipe shall meet all requirements herein, except that the pipe and coupling bands shall be fabricated from aluminum coated steel sheet meeting the requirements of AASHTO M274.

Page 10-71, Article 1032-4 Coated Culvert Pipe, replace (A), (1), (2), (3), (4), (B), (C), (D), (E), (F) and (G) with the following:

(A) Coatings for Steel Culvert Pipe or Pipe Arch

The below coating requirements apply for steel culvert pipe, pipe arch, end sections, tees, elbows and eccentric reducers.

- (1) Steel Culvert Pipe shall have an aluminized coating, meeting the requirement of AASHTO M274.
- (2) When shown on the plans developed by the Design-Build Team, and as approved by the Engineer, a polymeric coating meeting the requirements of AASHTO M246 for Type B coating may be substituted for aluminized coating.

(B) Acceptance

Acceptance of coated steel culvert pipe, and its accessories, shall be based on, but not limited to, visual inspections, classification requirements, check samples taken from material delivered to the project, and conformance to the annual Brand Registration.

Page 10-73, Article 1032-5, sixth paragraph, third sentence, remove the word "spelter"

Page 10-74, 1032-7 Vitrified Clay Culvert Pipe, delete section in its entirety.

Page 10-75, Article 1032-8 Welded Steel Pipe, change title to WELDED STEEL PIPE FOR DRAINAGE

Subarticle 1032-9(B) Plain Concrete Culvert Pipe, delete section in its entirety.

Page 10-77, Article 1032-10 Corrugated Polyethylene Culvert Pipe, change title to CORRUGATED POLYETHYLENE (HDPE) CULVERT PIPE

Add the following: Article 1032-11 Polyvinyl Chloride (PVC) Pipe

Polyvinyl Chloride pipe shall conform to AASHT M 304 or ASTM 949. When rubber gaskets are to be installed in the pipe joint, the gasket shall be the sole element relied on to maintain a tight joint. Test pipe joints at the plant hydrostatically using test methods in ASTM D 3212. Soil tight joints shall be watertight to 2 psi. Watertight joints shall be watertight to 5 psi unless a higher pressure rating is specified in the plans developed by the Design-Build Team.

DRAINAGE PIPE

(7-18-06) (Rev 1-19-10)

SP3 R36

Description

Where shown in the plans developed by the Design-Build Team, the Contractor shall use Reinforced Concrete Pipe, Corrugated Aluminum Alloy Pipe, Aluminized Corrugated Steel Pipe, Corrugated Polyethylene Pipe (HDPE Pipe) or Polyvinyl-Chloride Pipe (PVC Pipe) in accordance with the following requirements:

Material

Item	Section
Corrugated Aluminum Alloy Pipe	1032-2(A)
Aluminized Corrugated Steel Pipe	1032-3(A)(7)
Corrugated Polyethylene Pipe (HDPE)	1032-10
Reinforced Concrete Pipe – Class II or III	1032-9(C)
Polyvinyl-Chloride (PVC)	1032-11

Corrugated Steel Pipe shall not be permitted in counties listed in the Pipe Installation and Pipe Culverts Special Provision. In other counties, Corrugated Steel Pipe requires an acceptable coating in accordance with Section 1032-4 of the 2006 *Standard Specifications for Roads and Structures*.

Only pipe with smooth inside walls shall be allowed for storm drain systems. Storm drain systems are defined as pipe under curb and gutter, expressway gutter, and shoulder berm gutter that connects drainage structures and is not open ended.

All pipe types are subject to the maximum and minimum fill height requirements as found on Roadway Standard Detail 300D01 - Sheet 3 of 3. The appropriate Reinforced Concrete Pipe class and the appropriate gage thickness for Corrugated Aluminum Alloy Pipe and Aluminized Corrugated Steel Pipe shall be selected based on fill height.

Site specific conditions may limit a particular material beyond what is identified in this Special Provision. These conditions include, but are not limited to, abrasion, environmental, soil resistivity and pH, high ground water and special loading conditions. The Design-Build Team shall determine if additional restrictions are necessary.

Allowable side drain pipe material is outlined in Article 310-4 of the Pipe Installation and Pipe Culverts Special Provision.

Slope drains shall be Corrugated Aluminum Alloy Pipe, Aluminized Corrugated Steel Pipe, Corrugated Polyethylene Pipe (HDPE Pipe) or Polyvinyl-Chloride Pipe (PVC Pipe).

Transverse median drains, storm drainage system pipes, and open-ended cross drains shall be Reinforced Concrete Pipe unless the pipe slope is greater than 10%, in which case the pipe shall be either Corrugated Aluminum Alloy Pipe or Aluminized Corrugated Steel Pipe.

Construction Methods

Pipe Culverts shall be installed in accordance with the plans developed by the Design-Build Team, this RFP and the 2006 *Standard Specifications for Roads and Structures*.

Where allowed by the plans developed by the Design-Build Team, use any of the several alternate pipes shown herein, but only one type of pipe shall be permitted between drainage structures or for the entire length of a cross line pipe.

PIPE INSTALLATION AND PIPE CULVERTS

(1-19-10)

DB3R40

Revise the 2006 *Standard Specifications for Roads and Structures* as follows:

Replace Section 300 and Section 310 with the following:

SECTION 300**PIPE INSTALLATION****300-1 DESCRIPTION**

Excavate, undercut, provide material, condition foundation, lay pipe, joint and couple pipe sections, and furnish and place all backfill material as necessary to install the various types of pipe culverts and fittings required to complete the project.

Do not waste excavation unless permitted. Use suitable excavated material as backfill; or in the formation of embankments, subgrades, and shoulders; or as otherwise directed. Furnish disposal areas for the unsuitable material. The Engineer will identify excavated materials that are unsuitable.

Where traffic is to be maintained, install pipe in sections so that half the width of the roadway is available to traffic.

300-2 MATERIALS

Refer to Division 10:

Item	Section
Flowable Fill	1000
Select Materials	1016
Joint Materials	1032-9(G)
Engineering Fabric	1056-1

Provide foundation conditioning material meeting the requirements of Article 1016-3 for Class V or VI as shown on the plans developed by the Design-Build Team.

Provide bedding material meeting the requirements of Article 1016-3 for Class II (Type 1 only) or Class III as shown on the plans developed by the Design-Build Team.

Provide backfill material meeting the requirements of Article 1016-3 for Class II (Type 1 only) or Class III material as shown on the plans developed by the Design-Build Team.

Do not use corrugated steel pipe in the following counties:

Beaufort, Bertie, Bladen, Brunswick, Camden, Carteret, Chowan, Columbus, Craven, Currituck, Dare, Gates, Hertford, Hyde, Jones, Martin, New Hanover, Onslow, Pamlico, Pasquotank, Pender, Perquimans, Tyrrell and Washington.

300-3 UNLOADING AND HANDLING

Unload and handle pipe with reasonable care. Do not roll or drag metal pipe or plates over gravel or rock during handling. Take necessary precautions to ensure the method used in lifting

or placing the pipe does not induce stress fatigue in the pipe. Use a lifting device that uniformly distributes the weight of the pipe along its axis or circumference. Repair minor damage to pipe when permitted. Remove pipe from the project that is severely damaged or is rejected as being unfit for use. Undamaged portions of a joint or section may be used where partial lengths are required.

300-4 PREPARATION OF PIPE FOUNDATION

Prepare the pipe foundation in accordance with the applicable method as shown on the plans developed by the Design-Build Team, true to line and grade, and uniformly firm.

Camber invert grade an amount sufficient to prevent the development of sag or back slope in the flow line. The Contractor shall determine the amount of camber required and submit to the Engineer for approval.

Where material is found to be of poor supporting value or of rock and when the Engineer cannot make adjustment in the location of the pipe, undercut existing foundation material within the limits established on the plans developed by the Design-Build Team. Backfill the undercut with foundation conditioning material, Class V or VI select material. Encapsulate the foundation conditioning material with Type 4 engineering fabric prior to placing bedding material. Overlap all transverse and longitudinal joints in the fabric at least 18 inches.

Maintain the pipe foundation in a dry condition.

300-5 INVERT ELEVATIONS

No adjustment in contract time or compensation shall be granted for pipe field adjustments.

300 -6 LAYING PIPE

The Department reserves the right to perform forensic testing on any installed pipe.

(A) Rigid Pipe

Concrete and welded steel pipe shall be considered rigid pipe. Lay pipe on prepared foundation, bell or groove end upgrade with the spigot or tongue fully inserted. Check each joint for alignment and grade as the work proceeds.

Use flexible plastic joint material except when material of another type is specified on the plans developed by the Design-Build Team. Joint material of another type may be used when permitted.

Repair lift holes in concrete pipe, if present. Thoroughly clean and soak the lift hole and completely fill the void with an approved non-shrink gout. Submit alternate details for repairing lift holes to the engineer for review and approval.

For all pipes 42 inches in diameter and larger, wrap filter fabric around all pipe joints. Use Type 2 Class B fabric. Extend fabric at least 12 inches beyond each side of the joint. Secure the filter fabric against the outside of the pipe by methods approved by the Engineer.

(B) Flexible Pipe (Except Structural Plate Pipe)

Corrugated steel, corrugated aluminum, corrugated polyethylene (HDPE), and polyvinylchloride (PVC) pipe shall be considered flexible pipe. Place flexible pipe carefully on the prepared foundation starting at the downstream end with the inside circumferential laps pointing downstream and with the longitudinal laps at the side or quarter points.

Handle coated corrugated steel pipe with special care to avoid damage to coatings.

Join pipe sections with coupling band, fully bolted and properly sealed. Provide coupling bands for annular and helical corrugated metal pipe with circumferential and longitudinal strength sufficient to preserve the alignment, prevent separation of the sections, and prevent backfill infiltration. Match-mark all pipe 60 inches or larger in diameter at the plant for proper installation on the project.

At locations indicated on the plans developed by the Design-Build Team, corrugated steel pipe sections shall be jointed together with rod and lug coupling bands, fully bolted. Sleeve gaskets shall be used in conjunction with rod and lug couplings and the joints properly sealed. Coupling bands shall provide circumferential and longitudinal strength sufficient to preserve the alignment, prevent separation of the sections and prevent infiltration of backfill material.

300-7 BEDDING AND BACKFILLING

Loosely place bedding material, in a uniform layer, a depth equal to the inside diameter of the pipe divided by six or six inches, whichever is greater. Leave bedding material directly beneath the pipe uncompacted and allow pipe seating and backfill to accomplish compaction. Excavate recesses to receive the bells where bells and spigot type pipe is used.

Place fill around the pipe in accordance with the applicable method shown on the plans developed by the Design-Build Team in layers not to exceed 6 inches loose unless otherwise permitted. Compact to the density required by Subarticle 235-4(C). Approval of the backfill material is required prior to its use. Use select material as shown on the plans developed by the Design-Build Team.

Take care during backfill and compaction operations to maintain alignment and prevent damage to the joints. Keep backfill free from stones, frozen lumps, chunks of highly plastic clay, or other objectionable material.

Grade and maintain all pipe backfill areas in such a condition that erosion or saturation will not damage the pipe foundation or backfill.

Excavatable flowable fill may be used for backfill when approved by the Engineer. When using excavatable flowable fill, ensure that the pipe is not displaced and does not float during backfill. Submit methods for supporting the pipe and material placement to the Engineer for review and approval.

Do not operate heavy equipment over any pipe until it has been properly backfilled with a minimum three feet of cover. Place, maintain, and finally remove the required cover that is above the proposed finished grade at no cost to the Department. Remove and replace, at no cost to the Department, pipe that becomes misaligned, shows excessive settlement, or has been otherwise damaged by the Contractor's operations.

300-8 INSPECTION AND MAINTENANCE

Prior to final acceptance, the Engineer will perform random video camera and or mandrel inspections to ensure proper jointing and that deformations do not exceed allowable limits. Replace pipes having cracks greater than 0.1 inches or deflections greater than 7.5 percent. Repair or replace pipes with cracks greater than 0.01 inches, exhibiting displacement across a crack, exhibiting bulges, creases, tears, spalls, or delamination. Maintain all pipe installations in a condition such that they shall function continuously from the time the pipe is installed until the project is accepted.

300-9 MEASUREMENT AND PAYMENT

No separate payment will be made for any costs incurred for compliance with this Special Provision. All material and labor, including but not limited to foundation conditioning material, foundation conditioning fabric, select bedding and backfill material, pavement repair, and removal and disposal of existing pavement shall be included in the lump sum price bid for the entire project.

SECTION 310

PIPE CULVERTS

310-1 DESCRIPTION

Furnish and install drainage pipe at locations and size called for in the plans developed by the Design-Build Team. The work includes construction of joints and connections to other pipes, endwalls and drainage structures.

310-2 MATERIALS

Refer to Division 10:

Item	Section
Plain Concrete Pipe Culvert	1032-9(B)
Reinforced Concrete Pipe Culvert	1032-9(C)
Precast Concrete Pipe End Sections	1032-9(D)
Concrete Pipe Tees and Elbows	1032-9(E)
Corrugated Aluminum Alloy Pipe Culvert	1032-2(A)
Corrugated Aluminum Alloy Pipe Tees and Elbows	1032-2(B)
Corrugated Steel Culvert Pipe and Pipe Arch	1032-3(A)
Prefabricated Corrugated Steel Pipe End Sections	1032-3(B)
Corrugated Steel Pipe Tees and Elbows	1032-3(C)
Corrugated Steel Eccentric Reducers	1032-3(D)
HDPE Smooth Lined Corrugated Plastic Pipe	1032-10B
Polyvinylchloride (PVC) Pipe	1032-11(B)

Suppliers that provide metal pipe culverts, fittings and all other accessories covered by this section shall meet the requirements of the Department's Brand Certification program for metal pipe culverts, and be listed on the Department's pre-approved list for suppliers of metal pipe culvert.

Do not use corrugated steel pipe in the following counties:

Beaufort, Bertie, Bladen, Brunswick, Camden, Carteret, Chowan, Columbus, Craven, Currituck, Dare, Gates, Hertford, Hyde, Jones, Martin, New Hanover, Onslow, Pamlico, Pasquotank, Pender, Perquimans, Tyrell and Washington.

310-3 PIPE INSTALLATION

Install pipe, pipe tees and elbows in accordance with Section 300 above.

310-4 SIDE DRAIN PIPE

Side drain pipe shall be defined as storm drain pipe running parallel to the roadway, to include pipe in medians, outside ditches, driveways, and under shoulder berm gutter along outside shoulders greater than four feet wide.

Where shown in the plans developed by the Design-Build Team, side drain pipe may be class II reinforced concrete pipe, aluminized corrugated steel pipe, corrugated aluminum alloy pipe, HDPE pipe or PVC pipe. Corrugated steel pipe shall be restricted in the counties listed in Article 310-2 above. Install side drain pipe in accordance with Section 300 above. Cover for side drain pipe shall be at least one foot.

310-5 PIPE END SECTIONS

Choose which material to use for the required end sections. Both corrugated steel and concrete pipe end sections will be allowed on concrete pipe, corrugated steel pipe and HDPE smooth lined corrugated plastic pipe.

310-6 MEASUREMENT AND PAYMENT

No separate payment will be made for items covered by this Special Provision. All material and labor, including but not limited to linear feet of pipe, select bedding, backfill material, pipe end sections, tees, elbows and eccentric reducers, shall be considered incidental to the lump sum price bid for the entire project.

CEMENT AND LIME STABILIZATION OF SUB-GRADE SOILS

(07-12-07)

DB5 R21

General

The Design-Build Team shall be responsible for the following:

1. Performing all laboratory tests in a laboratory certified by the AMRL / NCDOT Laboratory Proficiency Program
2. Sampling Sub-grade soils
3. Conducting Laboratory tests to determine:
 - a. Soil classifications
 - b. Moisture-density relationships
 - c. Quantity of lime or cement required to achieve specified strengths
4. Designating areas to be stabilized by either lime or cement and the required rates of application
5. Conducting field tests to determine unconfined compressive strength

Sampling

The Design-Build Team shall take soil samples, after the project has been graded to within 2 inches of final sub-grade elevation. The Design-Build Team shall sample the top 8 inches at a minimum frequency of one sample per 1,000 feet, per each lane, for classification tests; and one sample per 3,000 feet, per each lane, for moisture density tests and lime or cement mix design tests. Additional samples shall be taken to ensure that all the predominant soil types, limits of distribution of these soils and different site conditions have been represented.

Classification Tests

The Design-Build Team shall perform the following tests to determine AASHTO classifications of different soils in accordance with AASHTO specifications as modified by NCDOT. Copies of these modified procedures can be obtained from Materials and Test Unit's Soils Laboratory.

TABLE 1

<u>TEST</u>	<u>AASHTO DESIGNATION</u>
Dry Preparation of Disturbed Soils	T-87
Particle Size Analysis of Soils	T-88
Determining the Liquid Limit of Soils	T-89
Determining the Plastic Limit and Plasticity Index of Soils	T-90

Moisture Density Test

Based on the criteria set in Table 2, below, the Design-Build Team shall perform the Moisture Density Tests, using either lime or cement. The Design-Build Team shall use 10% cement by weight in soil cement and 4% lime by weight, in soil-lime mixtures. The Design-Build Team shall conduct the tests in accordance with AASHTO T-99, and T-134 for soil-lime and soil-cement mixtures, respectively. In each case, The Design-Build Team shall determine the maximum dry density and optimum moisture content.

TABLE 2

<u>CRITERIA FOR SELECTING LIME OR CEMENT</u>		
PROPERTY	A	B
Percent passing #200 Sieve	35 Max	36 Min
Liquid Limit	40 Max	41 Min
Plasticity Index	10 Max	25 Min

The Design-Build Team shall use cement for all soils meeting criteria in Column A and lime for all soils meeting criteria in Column B. The Design-Build Team may choose either lime or cement for all soils not meeting all criteria in either Column A or B.

DETERMINING THE APPLICATION RATES FOR SOIL-CEMENT AND SOIL-LIME MIXTURES**Soil-Cement Mixtures**

For soil-cement mixtures, the Design-Build Team shall be required to do the following:

- Make specimens at optimum moisture content using a quantity of cement in the range of 5 to 12 percent by weight.
- Compact the specimens to a minimum density of 95% of maximum dry density obtained using AASHTO T 134.
- Make a minimum of 2 specimens for each selected cement rate.
- Cure the specimens for 7 days in a moist room maintained at a temperature of 73°F ±2.7° and a humidity of 100%. At the end of the curing period, immerse the specimens in water for 4 hours.
- After immersion, test the specimens in unconfined compression in accordance with ASTM D 1633.
- Report the maximum strength obtained and the corresponding percent strain.
- Select the rate of cement that provides a minimum unconfined compressive strength of 200 psi and a maximum of 400 psi.

Soil-Lime Mixtures

For soil-lime mixtures, the Design-Build Team shall be required to do the following:

- Make specimens at optimum moisture content using a quantity of lime in the range of 3.5 to 6.5 percent by weight.
- Compact specimens to a minimum density of 95% of maximum dry density obtained by AASHTO T99.
- Make a minimum of two specimens for each selected lime rate.
- Cure the specimens in sealed plastic bags for 48 hours in an oven at a temperature of 118 °F. Do not immerse the specimens in water at the end of the curing period.
- Test the specimens in unconfined compression in accordance with AASHTO T 208. Report the maximum strength obtained and the corresponding percent strain.
- Select the rate of lime that provides a minimum unconfined compressive strength of 60 psi.

Submittals for Review and Approval Prior to Construction

The Design-Build Team shall adhere to the following submittal guidelines:

- Submit all laboratory test results for review.

- Submit a sketch in plan view showing areas of the project to be stabilized by either lime or cement and application rates for each stabilizer.
- Submit any other documentation that supports the Design-Build Team's recommendations.

Construction of Lime Treated Subgrade

The Design-Build Team shall construct the lime treated sub-grade as specified in Section 501 of the North Carolina Department of Transportation *2006 Standard Specifications for Roads and Structures* with the following exceptions:

Subsection 501-4 Equipment

Contractor's equipment will not require engineer's approval.

Subsection 501-8 (A) General

Paragraph #1 is not applicable to this project.

Subsection 501-9 (B) Preliminary Curing

Amend as follows: Allow a minimum of 2 days and a maximum of 4 days for preliminary curing.

Subsection 501-10 Compacting, Shaping, and Finishing

Last paragraph is not applicable.

Subsection 501-11 Thickness

Last two paragraphs are not applicable.

Subsection 501-15 Method of Measurement

The entire sub-sections are not applicable.

Subsection 501-16 Basis of Payment

The entire sub-section is not applicable.

Construction of Cement Treated Subgrade

The Design-Build Team shall construct the soil cement sub-grade as specified in section 542 of the North Carolina Department of Transportation *2006 Standard Specifications for Roads and Structures*, with the following exceptions:

Subsection 542-4 Equipment

Contractor's equipment will not require Engineer's approval.

Subsection 542-7 Application of Cement

First paragraph is not applicable.

Subsection 542-11 Thickness

Paragraphs 2 and 3 are not applicable.

Subsection 542-16 Method of Measurement

This entire sub-section is not applicable.

Subsection 542-17 Basis of Payment

This entire sub-section is not applicable.

Unconfined Compressive Strength

The Design-Build Team shall allow a minimum of seven days curing before testing for strength.

The lime-stabilized subgrades shall be tested using Dynamic Cone Penetrometer (DCP) in accordance with *Quality Assurance Testing of Lime-Treated Soils Utilizing the Dynamic Cone Penetrometer*, Test Method #1-2005. The Design-Build Team shall adhere to the testing equipment requirements and procedures as outlined in *Dynamic Cone Penetrometer Testing for Subgrade Stability* except that the minimum penetration depth shall be eight inches. Upon request, a copy of the aforementioned documents can be obtained from the NCDOT Geotechnical Engineering Unit. The required unconfined compressive strength for lime shall be 60 psi, which corresponds to a penetration per blow of approximately 0.5 inches of the Dynamic Cone Penetrometer.

For cement-stabilized subgrades, the Design-Build Team shall make field specimens, cure them for seven days and test them in the laboratory. The minimum and maximum required unconfined compressive strength for soil cement shall be 200 psi and 400 psi, respectively.

For both lime and cement stabilized subgrades, one test shall be required for every 400 feet per lane width at random locations selected using random number tables.

Submittals for Review During Construction

The Design-Build Team shall submit the unconfined compressive strength and dynamic cone penetrometer test results for review and acceptance.

PRICE ADJUSTMENTS FOR ASPHALT BINDER

(7-21-09)

DB6 R25

Price adjustments for asphalt binder for plant mix will be made in accordance with Section 620 of the 2006 *Standard Specifications for Roads and Structures*.

When it is determined that the monthly selling price of asphalt binder on the first business day of the calendar month during which the last day of the partial payment period occurs varies either upward or downward from the Base Price Index, the partial payment for that period will be adjusted. The partial payment will be adjusted by adding the difference (+ or -) of the base price index subtracted from the monthly selling price multiplied by the total theoretical quantity of

asphalt binder authorized for use in the plant mix placed during the partial payment period involved.

The base price index for asphalt binder for plant mix is \$ per ton.

This base price index represents an average of F.O.B. selling prices of asphalt binder at supplier's terminals on .

PRICE ADJUSTMENTS - ASPHALT CONCRETE PLANT MIX

(04-03-07)

DB6 R26

Revise the 2006 *Standard Specifications for Roads and Structures* as follows:

Page 6-27, Article 609-8 and Page 6-49, Article 610-13

Add the following paragraph before the first paragraph:

The “Asphalt Price” used to calculate any price adjustments set forth in this section shall be \$35 per theoretical ton. This price shall apply for all mix types.

FIELD OFFICE

(6-1-07)

DB 08-01

Description

This work consists of furnishing, erecting, equipping, and maintaining a field office for the exclusive use of Department Engineers and Inspectors at a location on the project approved by the Engineer. Provide a field office that complies with the current A.D.A. Design and Accessibility Standards, the National Electric Code, local, state, and federal regulations, and the following:

Procedures

The field office and equipment shall remain the property of the Design-Build Team upon completion of the contract. The field office must be separated from buildings and trailers used by the Design-Build Team and be erected and functional as an initial operation. Failure to have the field office functional when work first begins on the project will result in withholding payment of the Design-Build Team's monthly progress estimate. The field office must be operational throughout the duration of the project and be removed upon completion and final acceptance of the project.

Provide a field office that is weatherproof, tightly floored and roofed, constructed with an air space above the ceiling for ventilation, supported above the ground, has a width of at least 10 feet, and the floor-to-ceiling height that is at least 7 feet 6 inches. Provide inside walls and a ceiling that are constructed of plywood, masonite, gypsum board, or other suitable materials. Have the exterior walls, ceiling, and floor insulated.

Provide a field office with a minimum floor space of 500 square feet and that is equipped with the following:

<u>Number</u>	<u>Item</u>
1	Double-pedestal desk (approximately 60 by 34 inches, at least 2,000 square inches)
1	Plan and drafting table (approximately 30 by 96 inches) with adjustable stool
1	Computer table having a minimum size of 48 by 30 by 29 inches
1	Plan rack for 24 by 36 inch drawings with 6 plan clamps
1	Printing calculator
2	2-drawer fire protection file, 15 inch drawer width, minimum UL rating of Class 350
6	Office chairs with a minimum of two having casters
2	Wastebaskets
1	Pencil sharpener
1	Copy machine (8 inch x 11 inch copies)
1	Telephone
1	Fax Machine
1	Answering machine.

Windows and Doors

Provide a field office with at least three windows, with blinds, each having an area of at least 540 square inches, capable of being easily opened and secured from the inside and having at least two exterior passage doors. Provide doors at least 30 inches in width and 78 inches in height. Provide screens for windows and doors. Equip exterior passage door(s) with lock(s), and furnish at least two keys to the Engineer or inspector.

Steps

Provide accessibility in compliance with the current A. D. A. Design and Accessibility Standards, and the State Building Code and maintain them free from obstructions.

Storage Facility For Nuclear Gage

Furnish the field office with an outside storage facility for the Department's nuclear gage. The storage facility shall not be located within 10 feet of any other structure including the field office.

Lighting, Heating, and Air Conditioning

The field office must have satisfactory lighting, electrical outlets, heating equipment, an exhaust fan, and an air conditioner connected to an operational power source. Provide at least one of the light fixtures that is a fluorescent light situated over the plan and drafting table. Furnish electrical current and fuel for heating equipment.

Fire Extinguishers

Furnish and maintain one fire extinguisher for each required exterior passage door. Fire extinguisher(s) may be chemical or dry powder. UL Classification 10-B:C (minimum), suitable for Type A:B:C: fires. Mount and maintain fire extinguisher(s) in accordance with OSHA Safety and Health Standards.

Toilets

Provide a toilet conforming to the requirements of the state and local boards of health or other bodies or courts having jurisdiction in the area. When separate facilities for men and women are not available, place a sign with the words "Rest Room" (with letters at least 1 inch in height) over the doorway, and provide an adequate positive locking system on the inside of the doorway. Maintain responsibility for the water and sewer connections or the installation and connection of a water well and septic tank and drain field. These facilities must conform to all local and state permits.

Utilities

Except for telephone service, make arrangement for necessary utility connections, maintain utilities, pay utility service fees and bills, and make arrangements for final disconnection of utilities. Furnish a telephone in each field office and permit the work necessary to install it. Installation and service fees for the telephone will be paid for by the Department.

Storage Facility for Test Equipment

Provide the field office with a storage facility, separate from the office for storage of test equipment, other than the nuclear gage. Provide a facility that has a minimum floor space of 64 square feet, is weatherproof, tightly floored and roofed, and has a tamper resistant key operated lock.

Miscellaneous Items

The field office must also include the following:

1. A certification that the office is free of asbestos and other hazardous materials.
2. A broom, dust pan, mop and bucket, and general cleaning supplies.
3. Provide and maintain an all weather parking area for six vehicles, including graveled access to the paved surface.

AUTOMATED MACHINE GUIDANCE

(6-17-08)

General

This Special Provision contains requirements that shall be followed if the Design-Build Team elects to use Global Positioning System (GPS) machine control grading and shall be used in

conjunction with Section 801 of the 2006 *Standard Specifications for Roads and Structures*. The use of this technology is referenced as Automated Machine Guidance (AMG).

All equipment using AMG shall be able to generate end results that adhere to the 2006 *Standard Specifications for Roads and Structures*. The Design-Build Team shall perform test sections for each type of work to be completed with AMG to demonstrate that the system has the capability to achieve acceptable results. If acceptable results can not be achieved, the Design-Build Team shall conform to the requirements for conventional stakeout.

The Design-Build Team shall be responsible for all errors resulting from the use of AMG and shall correct deficiencies to the satisfaction of the Engineer at no cost to the Department.

Submittals

If the Design-Build Team elects to use AMG, a Digital Terrain Model (DTM) of the design surface and all intermediate surfaces shall be developed in conjunction with plan development. The Engineer of Record shall certify that the model used for AMG is representative of the approved "Released for Construction" sealed plans. The certification and DTM files in TIN format shall be provided to the Engineer for review.

At least 90 days prior to beginning grading operations, the Design-Build Team shall submit to the Engineer an AMG Work Plan to include, but not be limited to, proposed equipment, control software manufacturer and version, types of work to be completed using AMG, project site calibration report, repetitive calibration methods for construction equipment and rover units to be used for the duration of the project, and local GPS base station to be used for broadcasting differential correction data to rover units. This may include the NC Network RTK. All surveys shall be tied to existing project control as established by the Department.

Inspection

The Engineer will perform quality assurance checks of all work associated with AMG. If it is determined that work is not being performed in a manner that will assure accurate results, the Engineer may require corrective action at no cost to the Department.

The Design-Build Team shall provide the Engineer with a GPS rover unit for use during the duration of the contract. The rover shall be loaded with the same model that is used with the AMG and shall have the same capability as rover units used by the Design-Build Team. The rover will be kept in the possession of the Engineer and will be returned to the Design-Build Team upon completion of the contract. Any maintenance or repairs required for the rover shall be the responsibility of the Design-Build Team. Formal training of at least 8 hours on the use of the proposed AMG system shall be provided to the Engineer by the Design-Build Team and the equipment manufacturer. Training shall include, but not be limited to, hardware, software, and operation of the rover unit.

Subgrade and Base Controls

If the Design-Build Team elects to use AMG for fine grading and placement of base or other roadway materials, the GPS shall be supplemented with a laser or robotic total station. Include

details of the proposed system in the AMG Work Plan. In addition, the following requirements apply for the use of AMG for subgrade and base construction.

- (A) Provide control points at intervals along the project not to exceed 1000 feet. The horizontal position of these points shall be determined by static GPS sessions or by traverse connection from the original base line control points. The elevation of these control points shall be established using differential leveling from project benchmarks, forming closed loops where practical. A copy of all new control point information shall be provided to the Engineer prior to construction activities.
- (B) Provide fine grade hubs referencing the top of finish grade along the cross section at 500-foot intervals. These hubs shall be established using conventional survey methods for use by the Engineer to check the accuracy of fine grading and pavement construction and shall remain in place until completion of all pavement layers unless otherwise allowed by the Engineer.
- (C) Provide conventional survey grade stakes at other critical points such as TSs, SCs, CSs, STs, PCs, PTs, and super elevation transition points as requested by the Engineer.

OVERHEAD SIGN SUPPORTS

Description

Design, fabricate, furnish and erect various types of overhead sign assemblies. The types of overhead sign assemblies included in this specification are span structures, cantilever structures and sign structures attached to bridges.

Materials

Structural Steel.....	Section 1072
Overhead Structures.....	Section 1096
Signing Materials	Section 1092
Organic Zinc Repair Paint	Article 1080-9
Reinforcing Steel	Section 1070

Construction Methods

A. General

Fabricate overhead sign assemblies in accordance with the details shown in the approved working drawings and the requirements of these specifications.

No welding, cutting or drilling in any manner shall be permitted in the field, unless prior approval by the Engineer is obtained.

Drill bolt holes and slots to finished size. Holes may also be punched to finished size, provided the diameter of the punched holes is at least twice the thickness of the metal being punched. Flame cutting of bolt holes and slots shall not be permitted.

Erect sign panels in accordance with the requirements for Type A or B signs as indicated in the plans or Roadway Standard Drawings. Field drill two holes per connection in the Z bars for attaching signs to overhead structures. Use two bolts at each connection.

Use two coats of a zinc-rich paint to touch up minor scars on all galvanized materials.

B. Shop Drawings

Design the overhead sign supports, including foundations, prior to fabrication. Submit computations and working drawings of the designs to the Engineer for review and acceptance.

Have a professional engineer registered in the State of North Carolina perform the computations and render a set of sealed, signed and dated drawings detailing the construction of each structure.

Submit to the Engineer for review and acceptance complete design and fabrication details for each overhead sign assembly, including foundations and brackets for supporting the signs and maintenance walkways. Base design upon the revised structure line drawings, wind load area and the wind speed shown in the plans, and in accordance with the *Standard Specifications for Structural Structures for Highway Signs, Luminaires and Traffic Signals*.

Submit thirteen (13) copies of completely detailed working drawings and one (1) copy of the design computations including all design assumptions for each overhead sign assembly to the Engineer for approval prior to fabrication. Working drawings shall include complete design and fabrication details (including foundations); provisions for attaching signs, maintenance walkways (when applicable), applicable material specifications, and any other information necessary for procuring and replacing any part of the complete overhead sign assembly.

Allow 15 days for initial working drawing review after the Engineer receives them. If revisions to working drawings are required, an additional 15 days shall be required for review and approval of the final working drawings.

Approval of working drawings by the Engineer shall not relieve the Design-Build Team of responsibility for the correctness of the drawings, or for the fit of all shop and field connections and anchors.

C. Design and Fabrication

The following criteria governs the design of overhead sign assemblies:

Design shall be in accordance with the *Standard Specifications for Structural Supports for Highway Signs, Luminaires and Traffic Signals, 4th Edition, 2001*, and the latest Interim Specifications.

Within this Specification, there are several design criteria that are owner specified. They include:

- The wind pressure map that is developed from the 3-second gust speeds, as provided in Article 3.8, shall be used.
- Overhead cantilever sign structures shall include galloping loads (exclude four-chord horizontal trusses), truck-induced gust loading and natural wind gust loading in the fatigue design, as provided for in Article 11.7.1, 11.7.4 and 11.7.3 respectively.
- The natural wind gust speed in North Carolina shall be assumed to be 11.2 mph for inland areas.
- The fatigue importance category used in the design, for each type of structure, as provided for in Article 11.6, Fatigue Importance Factors, shall be Category II unless otherwise shown on the contract plans.

The following Specification interpretations or criteria shall be used in the design of overhead sign assemblies:

- For design of supporting upright posts or columns, the effective length factor for columns “K”, as provided for in Appendix B, Section B.5, shall be taken as the following, unless otherwise approved by the Engineer:
 - Case 1 For a single upright post of cantilever or span type overhead sign structure, the effective column length factor, “K”, shall be taken as 2.0.
 - Case 2 For twin post truss-type upright post with the post connected to one chord of a horizontal truss, the effective column length factor for that column shall be taken as 2.0.
 - Case 3 For twin post truss-type upright post with the post connected to two truss chords of a horizontal tri-chord or box truss, the effective column length factor for that column shall be taken as 1.65
- For twin post truss-type upright post, the unbraced length shall be from the chord to post connection to the top of base plate.
- For twin post truss-type upright post, that is subject to axial compression, bending moment, shear, and torsion the post shall satisfy *Standard Specifications for Structural Supports for Highway Signs, Luminaries and Traffic Signals* Equations 5-17, 5-18 and 5-19. To reduce the effects of secondary bending, in lieu of Equation 5-18, the following equation may be used:

$$\frac{f_a}{F_a} + \frac{f_b}{\left(1 - \frac{0.6f_a}{F_e}\right)F_b} + \left(\frac{f_v}{F_v}\right)^2 \leq 1.0$$

Where f_a = Computed axial compression stress at base of post

- The base plate thickness for all uprights and poles shall be a minimum of 2" but not less than that determined by the following criteria and design.

Case 1 Circular or rectangular solid base plates with the upright pole welded to the top surface of base plate with full penetration butt weld, and where no stiffeners are provided. A base plate with a small center hole, which is less than 1/5 of the upright diameter, and located concentrically with the upright pole, may be considered as a solid base plate.

The magnitude of bending moment in the base plate, induced by the anchoring force of each anchor bolt shall be, $M = (P \times D_1) / 2$.

Case 2 Circular or rectangular base plate with the upright pole socketed into and attached to the base plate with two lines of fillet weld, and where no stiffeners are provided, or any base plate with a center hole that is larger in diameter than 1/5 of the upright diameter

The magnitude of bending moment induced by the anchoring force of each anchor bolt shall be $M = P \times D_2$.

- M - bending moment at the critical section of the base plate induced by one anchor bolt
 - P - anchoring force of each anchor bolt
 - D_1 - horizontal distance between the center of the anchor bolt and the outer face of the upright, or the difference between the radius of the bolt circle and the outside radius of the upright
 - D_2 - horizontal distance between the face of the upright and the face of the anchor bolt nut
- The critical section shall be located at the face of the anchor bolt and perpendicular to the radius of the bolt circle. The overlapped part of two adjacent critical sections shall be considered ineffective.
 - The thickness of base plate of Case 1 shall not be less than that calculated based on formula for Case 2.
 - Uprights, foundations, and trusses that support overhead signs shall be designed in accordance with the Overhead Sign Foundation Project Special Provision found elsewhere in this RFP for the effects of torsion. Torsion shall be considered from dead load eccentricity of these attachments, as well as for attachments such as walkways, supporting brackets, lights, etc., that add to the torsion in the assembly. Truss vertical and horizontal truss diagonals in particular and any other assembly members shall be appropriately sized for these loads.

- Uprights, foundations, and trusses that support overhead mounted signs shall be designed for the proposed sign wind area and future wind areas. The design shall consider the effect of torsion induced by the eccentric force location of the center of wind force above (or below) the center of the supporting truss. Truss vertical and horizontal truss diagonals in particular and any other assembly members shall be appropriately sized for these loads.

Fabricate all overhead sign assemblies, including but not limited to foundations, in accordance with the details shown on the approved shop drawings and with the requirements of these Specifications.

Fabricate the span and cantilever supporting structures using tubular members of either aluminum or steel, using only one type of material throughout the project. Sign support structures that are to be attached to bridges shall be fabricated using other structural shapes.

Horizontal components of the supporting structures for overhead signs may be of a truss design or a design using singular (monotube) horizontal members to support the sign panels. Provide permanent camber in addition to dead load camber in accordance with the *Standard Specifications for Structural Supports for Highway Signs, Luminaires, and Traffic Signals*. Indicate on the shop drawings the amount of camber provided and the method employed in the fabrication of the support to obtain the camber.

Use cantilever sign structures that meet the following design criteria:

- a. Do not exceed an $L / 150$ vertical dead load deflection at the end of the arm due to distortions in the arm and vertical support, where L is the length of the arm from the center of the vertical support to the outer edge of the sign.
- b. Do not exceed an $L / 40$ horizontal deflection at the end of the arm due to distortions in the arm and vertical support, as a result of design wind load.

Attach the overhead sign assemblies to concrete foundations by the use of galvanized anchor bolts with galvanized nuts, flat washers, and lock washers. For cantilever structure use a minimum of eight anchor bolts. Provide anchor bolts that have an anchor plate with nut at the end to be embedded in concrete.

Fabricate attachment assemblies for mounting signs in a manner that allows easy removal of sign panels for repair. Provide adequate supporting frames for mounting the lighting luminaires in the positions shown in the plans or approved shop drawings for all overhead sign assemblies to be illuminated.

Anchor Rod Assembly

Attach the overhead sign structure to concrete foundations by the use of straight galvanized anchor bolts with galvanized heavy hex nuts and flat washers. The rods and nuts shall be galvanized in accordance with AASHTO M232. The washers shall be galvanized in accordance

with AASHTO M298 Class C. For cantilever structures, use a minimum of eight anchor rods. Provide anchor rods that have an anchor plate with nut at the end to be embedded in concrete.

Ensure material used in steel anchor rods conforms to AASHTO M 314 or ASTM F1554, and the specified yield strength does not exceed 55,000 psi. Compute the required projection of the anchor rod above the foundation top. Compute the total projection based on the following:

- Provide between 3 and 5 threads of anchor rod projection above the top nut after tightening is complete. Avoid any additional projection, or a normal depth socket torque wrench shall not be used on top nuts.
- Include the sum of the thickness of top nut, top nut flat washer or top nut beveled washers, base plate, leveling nut flat washer or leveling nut beveled washers, leveling nut.
- Set the maximum distance between the bottom of the leveling nut and the foundation top to one nut height to avoid excessive bending stresses in the anchor rod under service conditions.
- Do not use lock washers.

Anchor Rod Nut Tightening Requirements

Prior to installation:

1. Protect the anchor rod threads from damage prior to and during installation.
2. Prior to installation of the rods in the foundation, turn nuts onto and off the rods, well past the elevation of the bottom of the leveling nuts. Turn by the effort of one worker using an ordinary wrench without a cheater bar. Report to the Engineer thread damage requiring unusually large effort.

During installation:

1. Place leveling nuts (bottom nuts) on the anchor rod.
2. Place leveling nut washers on top of the anchor rod leveling nuts.
3. Place a rigid template on top of the leveling nuts to check the level of the nuts. If the anchor nut and washer cannot be brought into firm contact with the template, then beveled washers shall be used.
4. Verify that the distance between the bottom of the leveling nut and the top of the concrete foundation is no more than one anchor rod diameter. If an upright is required to be back-raked, then the distance between the bottom of the leveling nut and the top of the concrete foundation shall be no more than one anchor rod diameter, averaged over the anchor rod group.
5. Place the base plate and structural element to which it is attached. However, do not attach to the upright element, during tightening of the anchor nuts, cantilever beams

- or arms with span in excess of 10 feet. Luminaire arms and fixtures may be attached prior to standing the pole on the foundation.
6. Place top nut washers.
 7. Do not use lock washers.
 8. Lubricate threads and bearing surfaces of top nuts. Lubricant shall be beeswax, stick paraffin, or other lubricant approved by the Engineer.
 9. Place top nuts. If the anchor nut and washer cannot be brought into firm contact with the base plate, then beveled washers shall be used.
 10. Tighten top nuts to snug-tight. A snug-tight condition is defined as the washer and nut being in full contact with the base plate, and the application of the full effort of a workman on a 12-inch wrench. Turn top nuts in increments following a star pattern (using at least two full tightening cycles).
 11. To ensure proper pretensioning, after all top nuts have been brought to snug-tight condition, repeat the procedure on the leveling nuts. Turn leveling nuts in increments following a star pattern (using at least two full tightening cycles).
 12. At this point, verify if beveled washers are required. Beveled washers shall be required under the leveling nut or top nut if any face of the base plate has a slope greater than 1:20 and / or any nut can not be brought into firm contact with the base plate.
 13. Before further nut turning, mark the reference position of the nut in the snug-tight condition with a suitable marking (ink or paint that is not water-soluble). Mark on the corner at the intersection of two flats with a corresponding reference mark on the base plate at each nut. After tightening, verify the nut rotation.
 14. Achieve pretensioning by turn-of-nut method. Turn the top nuts to 1/6 of a turn. Do so in a star pattern using at least two full-tightening cycles.
 15. After installation, ensure that firm contact exists between the anchor rod nuts, washers, and base plate on any anchor rod installed.
 16. For overhead sign assemblies: The span type truss or the cantilever truss may be placed on the uprights or attached to the upright at this time. For signal support structures: The span wires or mast arms may be attached to the upright at this time.
 17. After a period of no less than 4 days, and no more than 2 weeks, and in the presence of the Engineer, use a torque wrench to verify that a torque at least equal to 600 foot-pounds is provided on each top nut. For cantilever structures, verify the torque after erection of the remainder of the structure and any heavy attachments to the structure.

18. If any top nut torque reveals less than 600 foot-pounds of effort is required to move the nut, then tighten the nut to no less than 600 foot-pounds.
19. The Design-Build Team shall calibrate the torque indicator, and obtain corresponding certification, for all torque wrenches used for anchor nut tightening. The calibration and certification shall have occurred no more than 12 months prior to use of the torque wrench. Torque wrenches that were calibrated and certified more than twelve months prior to anchor nut tightening shall be re-calibrated and re-certified prior to use. Provide the Engineer a certification of such calibration.
20. Because inspection or re-tightening of the leveling nuts would be prevented, and to reduce moisture retention and associated corrosion, grout shall not be allowed under the base plate.

OVERHEAD SIGN FOUNDATIONS

Description

The work covered by this project special provision consists of the design and construction of overhead sign foundations in accordance with the submitted approved plans developed by the Design-Build Team and this provision. Design and construct either spread footing type foundations and / or drilled pier type foundations for each overhead sign unless otherwise directed by the Engineer.

Materials

Portland Cement Concrete Production and DeliverySection 1000
 Reinforcing Steel.....Section 1070
 Anchor BoltsArticle 1072-6
 Structural Steel and Overhead Sign StructuresSection 1072 and 1096

Construction Methods

A) General

A North Carolina Licensed Professional Engineer shall seal all design calculations, drawings and recommendations. Design foundations for the effects of dead, wind and ice loads in accordance with the wind zone load shown on the plans developed by the Design-Build Team and Section 3 of the *AASHTO Standard Specifications for Structural Supports for Highway Signs, Luminaries and Traffic Signals* (including interims). Use either spread footing or drilled pier foundations. In some instances, conflicts with drainage structures may dictate a certain type of foundation. Spread footings or dual drilled pier foundations shall be required for full span overhead signs (no single drilled pier foundations). When designing dual drilled pier foundations, a rectangular grade beam with a moment of inertia approximately equal to either of the drilled piers shall be required to connect the pier tops.

Provide reinforced concrete design in accordance with either Section 13.7.2 or 13.6.2 (whichever is applicable), allowable stress design method, of the *AASHTO Standard Specifications for Structural Supports for Highway Signs, Luminaries and Traffic Signals* (including interims).

Consider sloping ground in the design, if applicable. Do not exceed an allowable bearing pressure of 3 ksf for spread footings. For drilled pier foundations, do not exceed an allowable lateral soil pressure of 4 ksf for AASHTO Group II Loading. Use the following default soil parameters and groundwater elevation for foundation design in the absence of a site-specific subsurface investigation in accordance with this project special provision.

Total Unit Weight = 120 pcf

Friction Angle = 30 degrees

Cohesion = 0 psf

Assume the groundwater elevation is at a depth of 7 feet below the ground surface. If the groundwater is encountered at a depth shallower than 7 feet, the overhead sign foundation shall be redesigned based upon the actual field conditions. The default soil parameters and allowable pressures shall not apply to very soft or loose soil, muck (generally, SPT blow counts per foot less than 4), weathered rock or hard rock (generally, SPT refusal). If soft or loose soil, muck, weathered rock or hard rock conditions are present, a site-specific subsurface investigation and foundation design shall be required in accordance with this project special provision.

Design spread footings in accordance with Sections 4.4.1 through 4.4.10, allowable stress design method, of the *AASHTO Standard Specifications for Highway Bridges* (including interims). Restrict uplift due to the eccentricity of the loading to one corner of the footing and the tension area shall not exceed 25% of the total bearing area of the spread footing.

Design drilled piers in accordance with Sections 4.6.1 through 4.6.5, allowable stress design method, of the *AASHTO Standard Specifications for Highway Bridges* (including interims). If drilled piers are designed for skin friction only, increase the required length of each drilled pier a minimum of 6 inches to allow for sediment. If drilled piers are designed for end bearing, no additional length is required; however, the drilled piers shall be subject to the cleanliness requirements in Bottom Cleanliness under “Drilled Pier Construction:” below. Clearly state on the plans developed by the Design-Build Team whether end bearing was accounted for in the foundation design.

Calculate expected vertical, lateral and torsional movements for single drilled pier foundations. Provide drilled pier foundations that result in a horizontal lateral movement of less than 1 inch at the top of the pier and a horizontal rotational movement of less than 1 inch at the edge of the pier. Also, use a factor of safety of 2.0 for lateral and torsion failure. Preliminary design methods described in Section 13.6.1.1 of the *AASHTO Standard Specifications for Structural Supports for Highway Signs, Luminaries and Traffic Signals* (including interims) shall be used to incorporate a factor of safety in

foundation design for lateral failure. Wings shall be required to increase torsion resistance for cantilever signs supported by a single drilled pier.

If a site-specific subsurface investigation is performed, use only an NCDOT Highway Design Branch Pre-Qualified Geotechnical Engineering Firm to provide a site specific foundation design.

B) Subsurface Investigation

The Design-Build Team may elect to conduct a site specific subsurface investigation at each proposed overhead sign foundation location in lieu of using the default soil parameters and allowable pressures referenced above. In this case, and subject to the requirements below, perform a boring at each overhead sign foundation location and provide boring data on an NCDOT Standard Boring Log form. Download this form from the NCDOT site at

<http://www.ncdot.org/doh/preconstruct/highway/geotech/contractserv/investigation/Documents/BoringLogs.zip>.

A licensed geologist or a professional engineer registered in the State of North Carolina and employed by an NCDOT Highway Design Branch pre-qualified Geotechnical Engineering Firm shall seal each boring log. Use only an NCDOT Highway Design Branch pre-qualified Geotechnical Engineering Firm to conduct the subsurface investigation. Perform the investigation only after rough grade (within 3 feet of final grade) is achieved. Locate each boring within 3 feet of the center of the overhead sign foundation. Drill the boring to a minimum depth of 10 feet below the required spread footing bearing or drilled pier tip elevation, whichever is deeper. Conduct Standard Penetrating Tests at 1 foot, 2.5 feet, 5 feet, 7.5 feet, 10 feet and every 5 feet after 10 feet below the rough grade in accordance with ASTM D-1586. A boring may be terminated above the minimum depth required (10 feet below the foundation elevation) if one of the following conditions occur: (a) a total of 100 blows have been applied in any 2 consecutive 6-inch intervals; (b) a total of 50 blows have been applied with less than 3 inches of penetration.

C) Foundation Construction

Excavate footings for overhead sign structures in accordance with the applicable provisions of Section 410 of the 2006 *Standard Specifications for Roads and Structures*. Construct footings for overhead sign structures in accordance with Section 825 of the 2006 *Standard Specifications for Roads and Structures*. Construct all footings with Class A concrete. Where rectangular forms are used, use forms that have a chamfer strip at all corners for at least that distance protruding above finished ground. Use chamfers, which measure one-inch along the diagonal face.

Securely brace anchor bolts positioned in the form and hold in proper position and alignment. Provide a rubbed finish on concrete surfaces to be exposed above finished

ground in accordance with Section 825-6 (D) of the *2006 Standard Specifications for Roads and Structures*. Do not erect overhead sign structures on foundations until the concrete has reached a minimum compressive strength of 3000 psi. Determine concrete compressive strength by nondestructive test methods or compressive strength tests made in accordance with AASHTO T22 and T23. Furnish equipment used for nondestructive tests and obtain Engineer's approval prior to performing the tests.

D) Drilled Pier Construction

Excavation

Perform excavations for drilled piers to the required dimensions and lengths including all miscellaneous grading and excavation necessary to install the drilled pier. Depending on the subsurface conditions encountered excavation in hard rock, weathered rock or removal of boulders and debris may be required.

Dispose of drilling spoils as directed by the Engineer and in accordance with Section 802 of the *2006 Standard Specifications for Roads and Structures*. Drilling spoils consist of all material excavated including water or slurry removed from the excavation either by pumping or with augers.

Construct drilled piers within the tolerances specified herein. If tolerances are exceeded, provide additional construction as approved by the Engineer to bring the piers within the tolerances specified. Construct drilled piers such that the axis at the top of the piers is no more than 3 inches in any direction from the specified position. Build drilled piers within 1% of the plumb deviation for the total length of the piers. When a grade beam is not required at the top of a pier, locate the top of pier elevation between 18 inches above and 6 inches above the finished grade elevation. Form the top of the pier such that the concrete is smooth and level.

If unstable, caving or sloughing soils are anticipated or encountered, stabilize drilled pier excavations with steel casing and / or polymer slurry. Steel casing may be either the sectional type or one continuous corrugated or non-corrugated piece. All steel casings shall consist of clean watertight steel of ample strength to withstand handling and driving stresses and the pressures imposed by concrete, earth or backfill. Use steel casings with an outside diameter equal to the specified pier size and a minimum wall thickness of 1/4 inch. Extract all temporary casings during concrete placement in accordance with this project special provision unless the Design-Build Team chooses to leave the casing in place in accordance with the requirements below.

Any steel casing left in place will be considered permanent casing. When installing permanent casing do not drill or excavate below the tip of the permanent casing at any time such that the permanent casing is against undisturbed soil. The Design-Build Team may excavate a hole with a minimum diameter of 12 inches smaller than the specified size of the pier in order to facilitate permanent casing installation provided the sides of the excavation do not slough during drilling such that the hole

diameter becomes larger than the inside diameter of the casing. Permanent steel casings shall only be allowed for full span overhead signs as approved by the Engineer and prohibited for cantilever overhead signs. No additional compensation will be paid for permanent casing.

If the Design-Build Team elects to use polymer slurry to stabilize the excavation, use one of the polymers listed in the table below:

PRODUCT	MANUFACTURER
SlurryPro EXL	KB Technologies Ltd 3648 FM 1960 West Suite 107 Houston, TX 77068 (800) 525-5237
Super Mud	PDS Company 105 West Sharp Street El Dorado, AR 71730 (800) 243-7455
Shore Pac GCV	CETCO Drilling Products Group 1500 West Shure Drive Arlington Heights, IL 60004 (800) 527-9948

Use slurry in accordance with the manufacturer's guidelines and recommendations unless approved otherwise by the Engineer. The Design-Build Team should be aware that polymer slurry might not be appropriate for a given site. Polymer slurry shall not be used for excavations in very soft or loose soils. If the excavation can not be stabilized with polymer slurry, the Engineer may require a site-specific subsurface investigation (if not done during design) and the use of steel casing. No additional time or compensation will be provided if steel casing and / or polymer slurry are required to stabilize the excavation.

Construct all drilled piers such that the piers are cast against undisturbed soil. If a larger casing and drilled pier are required as a result of unstable or caving material during drilling, backfill the excavation before removing the casing to be replaced. No additional time or compensation will be provided for substituting a larger diameter drilled pier in order to construct a drilled pier cast against undisturbed soil.

Any temporary steel casing that becomes bound or fouled during pier construction and cannot be practically removed may constitute a defect in the drilled pier. Improve such defective piers to the satisfaction of the Engineer by removing the concrete and enlarging the drilled pier, providing a replacement pier or other approved means. All corrective measures including redesign as a result of defective piers shall not be cause for any claims or requests for additional time or compensation.

Bottom Cleanliness

If the plans developed by the Design-Build Team indicate end bearing was used in the design, after a drilled pier excavation is complete, and immediately before concrete placement, demonstrate acceptable bottom cleanliness of the drilled pier excavation to the Engineer for approval. Provide any equipment, personnel and assistance required for the Engineer to inspect the drilled pier excavation. The pier excavation bottom shall be considered clean if no portion of the bottom area has more than 3 inches of sediment as determined by the Engineer.

Reinforcing Steel

Completely assemble a cage of reinforcing steel consisting of longitudinal and spiral bars and place cage in the drilled pier excavation as a unit immediately upon completion of drilling unless the excavation is entirely cased. If the drilled pier excavation is entirely cased down to the tip, immediate placement of the reinforcing steel and the concrete is not required.

Lift the cage so racking and cage distortion does not occur. Keep the cage plumb during concrete placement operations and casing extraction. Check the position of the cage before and after placing the concrete.

Securely crosstie the vertical and spiral reinforcement at each intersection with double wire. Support or hold down the cage so that the vertical displacement during concrete placement and casing extraction does not exceed 2 inches.

Do not set the cage on the bottom of the drilled pier excavation. Place plastic bolsters under each vertical reinforcing bar that are tall enough to raise the rebar cage off the bottom of the drilled pier excavation a minimum of 3 inches.

In order to ensure a minimum of 3 inches of concrete cover and achieve concentric spacing of the cage within the pier, tie plastic spacer wheels at five points around the cage perimeter. Use spacer wheels that provide a minimum of 3 inches "blocking" from the outside face of the spiral bars to the outermost surface of the drilled pier. Tie spacer wheels that snap together with wire and allow them to rotate. Use spacer wheels that span at least two adjacent vertical bars. Start placing spacer wheels at the bottom of the cage and continue up along its length at maximum 10-foot

intervals. Supply additional peripheral spacer wheels at closer intervals as necessary or as directed by the Engineer.

Concrete

Begin concrete placement immediately after inserting reinforcing steel into the drilled pier excavation.

1) Concrete Mix

Provide the mix design for drilled pier concrete for approval and, except as modified herein, meeting the requirements of Section 1000 of the *2006 Standard Specifications for Roads and Structures*.

Designate the concrete as Drilled Pier Concrete with a minimum compressive strength of 4500 psi at 28 days. The Design-Build Team may use a high early strength mix design as approved by the Engineer. Make certain the cementitious material content complies with one of the following options:

- Provide a minimum cement content of 640 lbs / yd³ and a maximum cement content of 800 lbs / yd³; however, if the alkali content of the cement exceeds 0.4%, reduce the cement content by 20% and replace it with fly ash at the rate of 1.2 LB of fly ash per LB of cement removed.
- If Type IP blended cement is used, use a minimum of 665 lbs / yd³ Type IP blended cement and a maximum of 833 lbs / yd³ Type IP blended cement in the mix.

Limit the water-cementitious material ratio to a maximum of 0.45. Do not air-entrain drilled pier concrete.

Produce a workable mix so that vibrating or prodding is not required to consolidate the concrete. When placing the concrete, make certain the slump is between 5 and 7 inches for dry placement of concrete or 7 and 9 inches for wet placement of concrete.

Use Type I or Type II cement or Type IP blended cement and either No. 67 or No. 78M coarse aggregate in the mix. Use an NCDOT approved water-reducer, water-reducing retarder, high-range water-reducer or high-range water-reducing retarder to facilitate placement of the concrete, if necessary. Do not use a stabilizing admixture as a retarder in Drilled Pier Concrete without prior approval of the Engineer. Use admixtures that satisfy AASHTO M194 and add admixtures at the concrete plant when the mixing water is introduced into the concrete. Redosing of admixtures shall not be permitted.

Place the concrete within 2 hours after introducing the mixing water. Ensure that the concrete temperature at the time of placement is 90°F or less.

2) Concrete Placement

Place concrete such that the drilled pier is a monolithic structure. Temporary casing may be completely removed and concrete placement may be temporarily suspended when the concrete level is within 42 to 48 inches of the ground elevation to allow for placement of anchor bolts and construction of grade beam or wings. Do not pause concrete placement if unstable caving soils are present at the ground surface. Remove any water or slurry above the concrete and clean the concrete surface of all scum and sediment to expose clean, uncontaminated concrete before inserting the anchor bolts and conduit. Resume concrete pouring within 2 hours.

Do not dewater any drilled pier excavations unless the Engineer approves the dewatering and the excavation is entirely cased down to tip. Do not begin to remove the temporary casing until the level of concrete within the casing is in excess of 10 feet above the bottom of the casing being removed. Maintain the concrete level at least 10 feet above the bottom of casing throughout the entire casing extraction operation except when concrete is near the top of the drilled pier elevation. Maintain a sufficient head of concrete above the bottom of casing to overcome outside soil and water pressure. As the temporary casing is withdrawn, exercise care in maintaining an adequate level of concrete within the casing so that fluid trapped behind the casing is displaced upward and discharged at the ground surface without contaminating or displacing the drilled pier concrete. Exerting downward pressure, hammering or vibrating the temporary casing is permitted to facilitate extraction.

Keep a record of the volume of concrete placed in each drilled pier excavation and make it available to the Engineer.

After all the pumps have been removed from the excavation, the water inflow rate determines the concrete placement procedure. If the inflow rate is less than 6 inches per half-hour, the concrete placement shall be considered dry. If the water inflow rate is greater than 6 inches per half-hour, the concrete placement shall be considered wet.

- **Dry Placement:** Before placing concrete, make certain the drilled pier excavation is dry so the flow of concrete completely around the reinforcing steel can be certified by visual inspection. Place the concrete by free fall with a central drop method where the concrete is chuted directly down the center of the excavation.
- **Wet Placement:** Maintain a static water or slurry level in the excavation before placing concrete. Place concrete with a tremie or a pump in accordance with the applicable parts of Sections 420-4 and 420-5 of the *2006 Standard Specifications for Roads and Structures*. Use a tremie tube or pump pipe made of steel with watertight joints. Passing concrete

through a hopper at the tube end or through side openings as the tremie is retrieved during concrete placement is permitted. Use a discharge control to prevent concrete contamination when the tremie tube or pump pipe is initially placed in the excavation. Extend the tremie tube or pump pipe into the concrete a minimum of 5 feet at all times except when the concrete is initially introduced into the pier excavation. If the tremie tube or pump pipe pulls out of the concrete for any reason after the initial concrete is placed, restart concrete placement with a steel capped tremie tube or pump pipe.

Once the concrete in the excavation reaches the same elevation as the static water level, placing concrete with the dry method is permitted. Before changing to the dry method of concrete placement, remove any water or slurry above the concrete and clean the concrete surface of all scum and sediment to expose clean, uncontaminated concrete.

Vibration shall only be permitted, if needed, in the top 10 feet of the drilled pier or as approved by the Engineer. Remove any contaminated concrete from the top of the drilled pier and wasted concrete from the area surrounding the drilled pier upon completion.

3) Concrete Placement Time

Place concrete within the time frames specified in Table 1000-2 of the *2006 Standard Specifications for Roads and Structures* for Class AA concrete except as noted herein. Do not place concrete so fast as to trap air, water, fluids, soil or any other deleterious materials in the vicinity of the reinforcing steel and the annular zone between the rebar cage and the excavation walls. Should a delay occur because of concrete delivery or other factors reduce the placement rate to maintain some movement of the concrete. No more than 45 minutes shall be allowed between placements.

E) Scheduling and Restrictions

If caving or sloughing occurs, no additional compensation will be provided for additional concrete to fill the resulting voids.

During the first 16 hours after a drilled pier has achieved its initial concrete set as determined by the Engineer, do not drill adjacent piers, do not install adjacent piles and do not allow any heavy construction equipment loads or “excessive” vibrations to occur at any point within a 20 foot radius of the drilled pier.

In the event that the procedures described herein are performed unsatisfactorily, the Engineer reserves the right to shut down the construction operations or reject the drilled piers. If the integrity of a drilled pier is in question, use core drilling, sonic or other NCDOT approved methods at no additional cost to the Department and under the direction of the Engineer. Dewater and backfill core drill holes with an approved high

strength grout with a minimum compressive strength of 4500 psi. Propose remedial measures for any defective drilled piers and obtain approval of all proposals from the Engineer before implementation. No additional time or compensation will be provided for losses or damage due to remedial work or any investigation of drilled piers found defective or not in accordance with this project special provision or the plans developed by the Design-Build Team.

GENERAL

The State will not be bound by oral explanations or instructions given at any time during the bidding process or after award. Only information that is received in response to this RFP will be evaluated; reference to information previously submitted will not suffice as a response to this solicitation.

NO CONTACT CLAUSE

To ensure that information is distributed equitably to all short-listed Design-Build Teams, all questions and requests for information shall be directed to the State Contract Officer through the Design-Build e-mail address. This precludes any Design-Build Team Member, or representative, from contacting representatives of the Department, other State Agencies or Federal Agencies either by phone, e-mail or in person concerning the Design-Build Project.

USE OF TERMS

Throughout this RFP and all manuals, documents and standards referred to in the RFP the terms Contractor, Bidder, Design-Builder, Design-Build Team, Team, Firm, Company, and Proposer are synonymous.

Throughout this RFP and all manuals, documents and standards referred to in the RFP, the terms NCDOT, Department, Engineer, and State are synonymous.

Throughout this RFP and all documents referred to in the RFP, references to the Technical Proposal include all Technical Proposal supplemental information that may be submitted in response to a Best and Final Offer RFP.

DESIGN REFERENCES

Design references developed and published by NCDOT and those developed and published by other agencies and adopted for use by NCDOT which are to be used in the design of this project may be obtained by contacting Contract Standards and Development within the Technical Services Division. Standard prices for materials, which the Department normally sells for a fee, will be in effect. The Design-Build Team shall be responsible for designing in accordance with the applicable documents and current revisions and supplements thereto.

REVIEW OF SUBMITTALS

Major design milestones and required design submittals shall be identified as activities on a CPM, bar chart, or other scheduling tool. This schedule shall be submitted to the Transportation Program Management Director and Resident Engineer concurrently with the first design submittal, or within 30 days of the contract award, whichever is earlier. The schedule shall be revised and resubmitted as design milestones change or as directed by the Transportation Program Management Director. Submittals will be reviewed within 10 working days (15 days for temporary structures, overhead sign assemblies, MSE walls, FEMA compliance documents, and temporary shoring) from the date of receipt by NCDOT unless otherwise stipulated in the scope of work. All submittals shall be prepared and submitted in accordance with the "*Design-Build*

Submittal Guidelines”, which by reference are incorporated and made a part of this contract. All submittals shall be made simultaneously to the Transportation Program Management Director and the Resident Engineer. The Department will not accept subsequent submittals until prior submittal reviews have been completed for that item. The Design-Build Team shall inform the Transportation Program Management Director in writing of any proposed changes to the NCDOT preliminary designs, Technical Proposal and / or previously reviewed submittals and obtain approval prior to incorporation. The Design-Build Team shall prioritize submittals in the event that multiple submittals are made based on the current schedule. All submittals shall include pertinent Special Provisions. No work shall be performed prior to Department review of the design submittals.

OVERVIEW

The Design-Build Project, I-2304AC, is the widening of I-85 from North of SR 2120 (Long Ferry Road) to north of NC 150 in Rowan and Davidson counties. The proposed improvements consist of an eight-lane freeway with full control of access.

Project services shall include, but are not limited to:

- **Design Services** – completion of construction plans
- **Construction Services** – necessary to build and ensure workmanship of the designed facility
- **Permit Modification** - development of .documents for required permit modifications, if any
- **Right of Way** – acquisition of additional right of way necessary to construct project, if any
 - ✓ The EA was approved on November 6, 2000
 - ✓ The FONSI was approved on December 15, 2003
 - ✓ The Project Environmental Consultation (Right of Way and Construction Phase) was approved on May 15, 2009

Construction Engineering Inspection will be provided by the NCDOT Division personnel.

Proposers are to be made aware that this project procurement is dependent upon TIGER (Transportation Investment Generating Economic Recovery) grant funding, for which the Department as applied. As such, the Department reserves the right to suspend the project procurement or revise the project limits depending on the level of funding received from this discretionary grant program.

GENERAL SCOPE

The scope of work for this project includes design, construction and management of the project. The design work includes all aspects to construct an eight-lane freeway. The designs shall meet all appropriate latest versions of *AASHTO Policy on Geometric Design of Highways and Streets*, *AASHTO LRFD Bridge Design Specifications*, *Manual of Uniform Traffic Control Devices*, and all NCDOT design policies that are current as of the Technical and Price Proposal submission date or the Best and Final Offer submission date.

Construction shall include, but not be limited to, all necessary clearing, grading, roadway, drainage, structures, utility coordination and relocation, lighting, signing, on-site wetland mitigation and erosion and sediment control work items for the proposed eight-lane facility and installation of the control of access fence. Construction shall comply with 2006 *NCDOT Standard Specifications for Roadways and Structures* and any special provisions.

Areas of work required for this project shall include, but are not limited to the following items:

- Roadway Design
- Structure Design
- Hydraulic Design
- Permit Modification, as necessary
- Railroad Coordination, as necessary
- Subgrade Stabilization
- Foundation Design for Structures and Roadway
- Erosion and Sediment Control Design and Implementation
- R/W Utilities, Conflicts and / or Construction, as necessary
- Pavement Markings
- Sign Design
- Traffic Management
- Construction
- Project Management
- Design and Construction Management
- Construction Surveying
- Location and Surveys
- On-Site Mitigation, as necessary
- Lighting (Construction Only)
- Right of Way Acquisition, as necessary
- Public Involvement

All designs shall be in Microstation format using Geopak software (current version used by the Department).

DESIGN AND CONSTRUCTION PERFORMED BY DESIGN-BUILD TEAM

The design work consists of the preparation of all construction documents for constructing an eight-lane facility as outlined in the Scope of Work section of this RFP. The Design-Build Team shall prepare final designs, construction drawings and special provisions.

The Design-Build Team shall acknowledge that project documents furnished by the Department are preliminary and provided solely to assist the Design-Build Team in the development of the project design. The Design-Build Team shall be fully and totally responsible for the accuracy and completeness of all work performed under this contract and shall save the State harmless and shall be fully liable for any additional costs and all claims against the State which may arise due to errors, omissions and negligence of the Design-Build Team in performing the work required by this contract.

There shall be no assignment, subletting or transfer of the interest of the Design-Build Team in any of the work covered by the Contract without the written consent of the State, except that the Design-Build Team may, with prior written notification of such action to the State, sublet property searches and related services without further approval of the State.

The Design-Build Team shall certify all plans, specifications, estimates and engineering data furnished by the Team.

All work by the Design-Build Team shall be performed in a manner satisfactory to the State and in accordance with the established customs, practices, and procedures of the North Carolina Department of Transportation, and in conformity with the standards adopted by the American Association of State Highway Transportation Officials, and approved by the U.S. Secretary of Transportation as provided in Title 23, U.S. Code, Section 109 (b). The decision of the Engineer / State / Department shall control in all questions regarding location, type of design, dimension of design, and similar questions.

Alternate designs, details, or construction practices (such as those employed by other states, but not standard practice in NC) are subject to Department review and will be evaluated on a case by case basis.

The Design-Build Team shall not change team members, subconsultants or subcontractors identified in the Statement of Qualifications (SOQ) or Technical Proposal without written consent of the Engineer or the State Contract Officer. In addition, subconsultants and subcontractors not identified in the SOQ or Technical Proposal shall not perform any work without written consent by the Engineer. Individual offices of the Design-Build Team not identified in the Statement of Qualifications or the Technical Proposal submitted shall not perform any work without written consent by the Engineer. Failure to comply with this requirement may be justification for removing the Team from further consideration for this project and disqualification from submitting on future Design-Build Projects.

All firms shall be prequalified by the Department for the work they are to perform. Joint Ventures, LLCs or any legal structure that are different than the existing prequalification status must be prequalified prior to the Technical and Price Proposal submittal deadline. Subcontractors need only be prequalified prior to performing the work. Design firms should be prequalified prior to the Technical and Price Proposal submittal deadline. If not prequalified at the time of the Technical and Price Proposal submittal deadline, the prime contractor shall be solely responsible for either (1) ensuring that the design firm is prequalified prior to its first design submittal or (2) replacing that firm with a prequalified firm. Design firms and Natural Systems firms are prequalified by the particular office performing the work. If the work is to be performed by an office other than the one that is prequalified, that office shall be prequalified prior to any design submittals.

ETHICS POLICY

Employees employed by the Design-Build Team or employees employed by any subconsultant for the Design-Build Team to provide services for this project shall comply with the Department's ethics policy. Failure to comply with the ethics policy will result in the employee's removal from the project and may result in removal of the Company from the Department's appropriate prequalified list.

APPROVAL OF PERSONNEL

The Department will have the right to approve or reject any personnel, assigned to a project by the Design-Build Team.

The Design-Build Team or any subcontractor for the Design-Build Team which are employed to provide services for this project shall not discuss employment opportunities or engage the services of any person or persons, now in the employment of the State during the time of this contract, without written consent of the State.

In the event of engagement, the Design-Build Team or their subcontractors shall restrict such person or persons from working on any of the Design-Build Team's contracted projects in which the person or persons were "formerly involved" while employed by the State. The restriction period shall be for the duration of the contracted project with which the person was involved. *Former Involvement* shall be defined as active participation in any of the following activities:

- Drafting the contract
- Defining the scope of the contract
- Selection of the Design-Build Team
- Negotiation of the cost of the contract (including calculating manhours or fees); and
- Administration of the contract.

An exception to these terms may be granted when recommended by the Secretary and approved by the Board of Transportation.

Failure to comply with the terms stated above in this section shall be grounds for termination of this contract and / or not being considered for selection of work on future contracts for a period of one year.

SUBMITTAL OF TECHNICAL AND PRICE PROPOSALS

Technical and / or Price Proposals that do not adhere to all the requirements noted below may be considered non-responsive and may result in the Department not considering the Design-Build Team for award of the contract or reading their Price Proposal publicly.

GENERAL

Technical and Price Proposals will be accepted until **4:00 p.m. Local Time on Thursday, March 11, 2010**, at the office of the State Contract Officer:

Mr. Randy A. Garris, PE
NCDOT - Contract Standards and Development
1020 Birch Ridge Drive
Century Center - Building B
Raleigh, NC 27610

No Proposals will be accepted after the time specified.

Proposals shall be submitted in 2 separate, sealed parcels containing the Technical Proposal in one and the Price Proposal in the other parcel.

TECHNICAL PROPOSAL

Technical Proposals shall be submitted in a sealed package. The outer wrapping shall clearly indicate the following information:

Technical Proposal
Submitted By: (Design-Build Team's Name)
Contract Number C202383
TIP Number I-2304AC
Rowan & Davidson Counties
Widening of I-85 from north of SR 2120 (Long Ferry Road) to north of NC 150

Technical Proposal Requirements

12 Copies
8 ½ inch by 11 inch pages
Printed on one side only
Double-spaced
Font size 12
No more than 50 pages, excluding the introductory letter to Mr. Randy Garris, P.E. (two-page maximum length) and the 11 inch by 17 inch appropriate plan sheets
24 x 36 inch fold out sheets will only be allowed to present interchange plans

Key Project Team members, identified in the Statement of Qualifications, shall not be modified in the Technical Proposal without written approval of the Department. Any such request should be sent to the attention of Mr. Randy Garris, PE, at the address below:

NCDOT - Contract Standards and Development
Century Center Complex - Building B
1020 Birch Ridge Drive
Raleigh, NC 27610

PRICE PROPOSAL

Price Proposals shall be submitted in a sealed package. The outer wrapping will clearly indicate the following information:

Price Proposal
Submitted by (Design-Build Team's Name)
Contract Number C202383
TIP Number I-2304AC
Rowan & Davidson Counties
Widening of I-85 from north of SR 2120 (Long Ferry Road) to north of NC 150

The Price Proposal shall be submitted by returning the Request for Proposals with the item sheets completed, and all required signatures and bonds. Failure to execute the required documents may render the proposal non-responsive.

EVALUATIONS

Decisions based on cost alone will not establish the design standards for the project. Technical Proposals shall address the technical elements of the design and construction of the project. The Technical Review Committee will consider the understanding of the project, the anticipated problems and the solutions to those problems, in addition to other evaluation criteria identified herein.

The Design-Build Team's Technical Proposal shall be developed using narratives, tables, charts, plots, drawings and sketches as appropriate. The purpose of the Technical Proposal is to document the firm's understanding of the project, demonstrate the Team's capabilities to complete the project, document their selection of appropriate design criteria, and state their approach and schedule for completing all design and construction activities.

The review of design plans by the Department is not intended to reflect a reviewer's personal preferences, but rather to ensure that all contract requirements are met, sound engineering judgment is exercised by the Design-Build Team, and that the Design-Build Team adheres to all referenced documents, including but not limited to, design standards, codes, memos and manuals. As such, the award of the Design-Build contract does not in any way imply that the NCDOT accepts the details of the Technical Proposal submitted by the Design-Build Team.

The Technical Proposal will be evaluated in each of the following major categories:

EVALUATION FACTORS	POINTS
1. Management	15
2. Responsiveness to Request for Proposal	27
3. Long Term Maintenance	8
4. Schedule and Milestones	23
5. Innovation	8
6. Maintenance of Traffic and Safety Plan	15
7. Oral Interview	4

TECHNICAL PROPOSAL EVALUATION CRITERIA

1. Management – 15 points

Design-Build Team Management

- Describe the Design-Build Team's concept of design management. The proposal shall identify key positions and subordinate organizational units.
- Describe the plan for the coordination of civil / structural, utilities, traffic maintenance, constructability and environmental responsibility.
- Provide a narrative description of the proposed location of the design office(s) and their respective responsibilities.
- Describe how the designs developed by different firms and offices will be integrated.
- Describe how design personnel will interface with the construction personnel.
- Describe the overall strengths of the Design Team and their ability to fulfill the design requirements of this project.
- Identify a Traffic Control Supervisor and detail the supervisor's qualifications.

Quality Management

- Describe how the Design-Build Team will comply with the quality control requirements for both design and construction. Specifically, include a narrative describing the Design-Build Team's understanding of the Department's construction quality control philosophy for this project and how the Design-Build Team will implement it.
- The Design-Build Team should detail the number of inspectors they expect the Department to furnish, during various phases, to allow satisfactory progress of project construction.
- Describe any significant quality control issues experienced on NCDOT projects in the last ten years and how those issues will be addressed for this project.
- The narrative shall include both design and construction activities.

Construction Management

- Describe the Design-Build Team's concept of the project construction management organization and how it interrelates with the other elements of the Design-Build Team's organization for the project.
- Provide a brief narrative description of the Design-Build Team's proposed plan for performing construction on the project. This description shall include at least the following:
 - A construction organization chart for the project, showing the relationships between functions shown on the chart and the functional relationships with subcontractors.
 - The chart shall indicate how the Design-Build Team intends to divide the project into work segments to enable optimum construction performance.

- Descriptions of those categories of work that the Design-Build Team anticipates will be performed by the Design-Build Team's own direct labor force and those categories that will be performed by subcontractors.
- The Design-Build Team's plans and procedures to insure timely deliveries of materials to achieve the project schedule.
- Describe the overall strengths of the construction team and their ability to fulfill the construction and construction management requirements of this project.
- Describe the Design-Build Team's approach to site access and material staging.

2. Responsiveness to RFP – 27 points

Natural Environmental Responsibility

- Describe the Design-Build Team's approach to addressing environmental concerns within the project boundaries.
- Identify efforts to minimize impacts on wetlands, streams, riparian buffers, and other environmentally sensitive areas.
- Describe any temporary impacts and associated minimization approaches.
- Describe any need for a permit modification and the Design-Build Team's understanding of the overall approach to permitting.
- Identify methods of construction in wetlands, streams, and buffers.
- Describe any Notice of Violations (NOVs) or Immediate Corrective Actions (ICAs) the Design-Build Team members have received in the last five years and the disposition of any NOVs or ICAs.
- Describe the Design-Build Teams approach to Sedimentation and Erosion Control for the project.
- Describe the Design-Build Team's approach to and plan for On-Site Mitigation.

Design Features

- Show plan view of design concepts with key elements noted.
- Identify preliminary horizontal and vertical alignments of all roadway elements.
- Show typical sections for the mainline of the project.
- Identify drainage modifications and designs to be implemented.
- Identify the appropriate design criteria for each feature if not provided.
- Identify all bridge types to be constructed, including any special design features or construction techniques needed.
- Identify any deviations, including proposed design exceptions, from the established design criteria that will be utilized. Explain why the deviation is necessary. Describe any geotechnical investigations to be performed by the Design-Build Team.
- Identify any special aesthetics considerations that will be part of the design.
- Describe how any utility conflicts will be addressed and any special utility design considerations. Describe how the Design-Build Team's design and construction methods minimize the Department's utility relocation costs.
- Describe if the design will require any additional right-of-way or easements beyond that already acquired by the Department, and if so, to what extent.

- Identify types of any retaining walls and / or noise walls if applicable.
- Address the design details within the boundaries of the Yadkin River Hydroelectric Project or any modifications that are needed to the railroad agreements already secured by the Department.

3. Long Term Maintenance – 8 points

- Describe any special materials, not referenced elsewhere in the contract, incorporated into the project that would result in long term reduction in maintenance.
- Describe any special designs or construction methods that would reduce future maintenance costs to the Department.
- Estimate a minimum ten-year cost saving resulting from incorporation of these special materials, design, or construction methods into the project.

4. Schedule and Milestones – 23 points

- Provide a detailed schedule for the project including both design and construction activities. The schedule shall show the sequence and continuity of operations, as well as the month of delivery of usable segments of the project.
- The schedule shall also include the Design-Build Team's final completion date and, if proposed, their substantial completion date. These dates shall be clearly indicated on the **Project Schedule and labeled "Final Completion Date" and "Substantial Completion Date"**.

5. Innovation – 8 points

- Identify any aspects of the design or construction elements that the Design-Build Team considers innovative. Include a description of alternatives that were considered whether implemented or not.

6. Maintenance of Traffic and Safety Plan – 15 points

Maintenance of Traffic

- Describe any traffic control requirements that will be used for each construction phase.
- Describe how traffic will be maintained as appropriate and describe the Design-Build Team's understanding of any time restrictions noted in the RFP.
- Specifically describe how business, school, and residential access will be maintained, if applicable.
- Address how hauling will be conducted.
- If a temporary portable barrier system will be utilized, provide the type and why it is needed.
- If temporary shoring will be required, provide the type and why it is required.
- Include all proposed offsite detours; reason for need and duration.
- Describe quantitatively the impacts (duration, traffic maintenance, I-85 incident management, etc.) to US 29 / US 70 and NC 150 due to the construction / demolition sequencing of the US 29 / US 70 bridges and approaches.

Safety Plan

- Describe the safety considerations specific to the project.
- Discuss the Design-Build Team's overall approach to safety.
- Describe any proposed improvements that will be made prior to or during construction that will enhance the safety of the work force and/or travelling public both during and after the construction of the project.

7. Oral Interview – 4 points

- The Design-Build Team's Project Management Team shall present a brief introduction of the project team and design / construction approach.
- Introductory comments shall be held to no more than 30 minutes.
- The Department will use this interview to ask specific questions about the Team's Technical Proposal, background, philosophies, and approach to the project.
- Presentation, questions, and answers shall not exceed 90 minutes. No more than 10 people from the Design-Build Team may attend.

The Department will use the information presented in the oral interview to assist in the evaluation of the Technical Proposal.

Additional Warranty and / or Guarantee

- **The Extra Credit for this project shall be a Maximum of 5 Points.**

A twelve-month guarantee as outlined in the *Twelve-Month Guarantee* Project Special Provision is required for this project. However, the Design-Build Team may provide additional warranties and / or guarantees at their discretion. The Design-Build Team may be awarded additional points as "extra credit" to be added to the technical score.

The Design-Build Team may provide warranties and / or guarantees for major components of the project. Examples of major components are pavements, bridge components, on-site mitigation and sign structures. If additional warranties and / or guarantees are offered, the Design-Build Team shall indicate in the Technical Proposal the general terms of the warranties and / or guarantees, a list of the items covered, performance parameters, notification and response parameters for corrective action, and evaluation periods. The Department will be responsible for annual inspections of the components covered by all warranties and / or guarantees offered by the Design-Build Team that extend beyond the required Twelve-Month Guarantee. The warranties and / or guarantees shall also define how disputes will be handled. Prior to the first partial payment, the Design-Build Team shall submit a document that provides additional warranty / guarantee specifics in sufficient detail that allows the document to be made a part of the contract through supplemental agreement.

No direct payment will be made for warranties and / or guarantees. Payment will be considered incidental to the lump sum price for the contract.

SELECTION PROCEDURE

There will be a Technical Review Committee (TRC) composed of five or more senior personnel from involved engineering groups that will evaluate the Technical Proposal on the basis of the criteria provided in the Request For Proposals.

The selection of a Design-Build Team will involve both technical quality and price. The Technical Proposals will be presented to the TRC for evaluation. The TRC shall first determine whether the proposals are responsive to the requirements of the Request for Proposals. The Department reserves the right to ask for clarification on any item in the Technical Proposal. A written response to this request for clarification shall be provided to the Department prior to the opening of the Price Proposals. The contents of the written response may affect the Technical Review Committee's determination of the Technical Proposal's responsiveness and/or the overall evaluation of the Technical Proposal. If any commitments or clarifications provided in the written response conflict with the contents of the Technical Proposal, the contents of the written response will govern and be incorporated into the contract.

Each responsive Technical Proposal shall be evaluated based on the rating criteria provided in the Request for Proposals. The TRC will submit an overall consensus Technical Proposal score for each Design-Build Team to the State Contract Officer.

Quality Credit Evaluation Factors for Technical Proposals

Management	15
Responsiveness to Request for Proposal	27
Long Term Maintenance	8
Schedule and Milestones	23
Innovation	8
Maintenance of Traffic and Safety Plan	15
Oral Interview	4
Maximum Score	100

The State Contract Officer will use a table based on the maximum quality credit percentage to assign a Quality Credit Percentage to each proposal based on the proposal's overall technical score. The maximum quality credit percentage for this project will be **25%**.

Quality Credit Percentage for Technical Proposals

Technical Score	Quality Credit (%)	Technical Score	Quality Credit (%)
100	25.00	84	11.67
99	24.17	83	10.83
98	23.33	82	10.00
97	22.50	81	9.17
96	21.67	80	8.33
95	20.83	79	7.50
94	20.00	78	6.67
93	19.17	77	5.83
92	18.33	76	5.00
91	17.50	75	4.17
90	16.67	74	3.33
89	15.83	73	2.50
88	15.00	72	1.67
87	14.17	71	0.83
86	13.33	70	0.00
85	12.50		

The maximum Technical Score, including any extra credit given for warranties or guarantees, shall not exceed 100 points in determining the Quality Credit percentage.

If any of the Technical Proposals are considered non-responsive, the State Contract Officer will notify those Design-Build Teams of that fact. The State Contract Officer shall publicly open the sealed Price Proposals and multiply each Design-Build Team's Price Proposal by the Quality Credit Percentage earned by the Design-Build Team's Technical Proposal to obtain the Quality Value of each Design-Build Team's Technical Proposal. The Quality Value will then be subtracted from each Design-Build Team's Price Proposal to obtain an Adjusted Price based upon Price and Quality combined. Unless all Proposals are rejected or the Department elects to proceed with the Best and Final Offer process, the Department will recommend to the State Transportation Board that the Design-Build Team having the lowest adjusted price be awarded the contract. The cost of the design-build contract will be received as the Price Proposal.

The following table shows an example of the calculations involved in this process.

An Example of Calculating Quality Adjusted Price Ranking

Proposal	Technical Score	Quality Credit (%)	Price Proposal (\$)	Quality Value (\$)	Adjusted Price (\$)
A	95	20.83	3,000,000	624,900	2,375,100
B	90	16.67	2,900,000	483,430	2,416,570
C *	90	16.67	2,800,000	466,760	2,333,240
D	80	8.33	2,700,000	224,910	2,475,090
E	70	0.00	2,600,000	0	2,600,000
* Successful Design-Build Team – Contract Cost \$2,800,000					

Opening of Price Proposals

Prior to opening the Price Proposals, the State Contract Officer will provide to each Design-Build Team their technical score in a sealed envelope. The sealed envelope will contain that Team's score only.

At the time and date specified, the State Contract Officer will open the Price Proposals and calculate the percentage difference between the Price Proposals submitted and the Engineer's Estimate.

Should all of the Price Proposals be within an acceptable range or below the Engineer's Estimate the State Contract Officer will proceed to calculate the quality credit and publicly read the Price Proposal, technical score, and adjusted price as outlined in the selection procedure above.

Should any one or more of the Price Proposals be within an acceptable range or below the Engineer's Estimate and the remaining Price Proposals exceed an acceptable range of the Engineer's Estimate the State Contract Officer will go to a separate location to calculate the quality credit and determine if the Design-Build Team with the lowest adjusted price is within an acceptable range of the Engineer's Estimate. Should the Price Proposal of the Design-Build Team with the lowest adjusted price be within an acceptable range of the Engineer's Estimate or below the Engineer's Estimate the State Contract Officer will proceed to publicly read the Price Proposals, technical scores, and adjusted prices. Should the Price Proposal of the Design-Build Team with the lowest adjusted price exceed an acceptable range of the Engineer's Estimate the State Contract Officer will publicly read the Price Proposals only and the Department will then determine whether to proceed to request a Best and Final Offer (BAFO) as outlined below.

Should all Price Proposals submitted exceed an acceptable range of the Engineer's Estimate the State Contract Officer will publicly read the Price Proposals only. The Department will then determine whether to proceed to request a Best and Final Offer (BAFO) as outlined below.

Provided the Department elects to proceed to request a Best and Final Offer (BAFO), at the date and time specified, the State Contract Officer will open the Best and Final Offer Price Proposals and proceed to publicly read all Price Proposals, technical scores and adjusted prices.

Best and Final Offer

In the event initial Price Proposals exceed an acceptable range of the Engineer's Estimate or if the Department feels it is necessary for any reason the Department may choose to make amendments to the details of the RFP and request a Best and Final Offer from all of the previously short-listed teams. Alternately, the Department may choose to redistribute to the short-listed Design-Build Teams another RFP for the project with no amendments to the RFP scope.

After receipt of the redistributed RFP, the Design-Build Team has the option of changing their Technical Proposal details. If the Design-Build Team changes any component of the Technical Proposal, the TRC will review those amended components of the Technical Proposal and reevaluate the scores accordingly. The Design-Build Team shall highlight the changes to bring them to the Department's attention. A revised total score will be calculated, if appropriate, based on these amendments to the Technical Proposal.

Additional oral interviews will not be held. The Design-Build Teams shall submit both a revised Price Proposal and a revised Technical Proposal (if applicable) at the time, place, and date specified in the redistributed RFP. A revised Quality Credit Percentage (if required) and Adjusted Price will be determined. This will constitute the Design-Build Team's Best and Final Offer. Award of the project may be made to the Design-Build Team with the lowest adjusted price on this Best and Final Offer for the project.

Stipend

A stipulated fee of **\$100,000** will be awarded to each short-listed Design-Build Team that provides a responsive, but unsuccessful, Design-Build Proposal. If a contract award is not made, all short-listed Design-Build Teams that provide a responsive Design-Build Proposal shall receive the stipulated fee. Once award is made, or a decision is made not to award, unsuccessful Design-Build Teams will be notified of the opportunity to apply for the stipulated fee. If the Design-Build Team accepts the stipulated fee, the Department reserves the right to use any ideas or information contained in the Design-Build Proposals in connection with any contract awarded for the project, or in connection with any subsequent procurement, with no obligation to pay additional compensation to the unsuccessful Design-Build Team. The stipulated fee shall be paid to eligible Design-Build Teams within ninety days after the award of the contract or the decision not to award. Unsuccessful Design-Build Teams may elect to refuse payment of the stipulated fee and retain any rights to its Design-Build Proposal and the ideas and information contained therein.

In the event that the Department suspends or discontinues the procurement process prior to the Design-Build Proposal submittal date current at the time of the suspension, no stipulated fee will be paid.

ROADWAY SCOPE OF WORK (12-21-09)

It should be noted that TIP Project I-2304AC, as referenced herein, represents a project formerly designated as I-2304AA. All references to project I-2304AA in material provided by the Department shall apply to this project.

Project Details

- The Design-Build Team shall design and construct an eight-lane divided freeway with a minimum 46-foot median from north of SR 2120 (Long Ferry Road) in Rowan County to Station 980+00 -L- of the I-2304AA Right of Way Plans provided by the Department. Unless noted otherwise elsewhere in this RFP, the Design-Build Team shall design and construct the -L- Line providing the same or better access, widening and improvements included in the I-2304AA Right of Way Plans provided by the Department. The limits of -L- Line construction shall be of sufficient length to tie to existing based upon the current NCDOT guidelines and standards. The mainline shall be designed and constructed to meet a 70-mph design speed for a rolling rural freeway designed to Interstate standards. The Design-Build Team shall provide all other design criteria in the Technical Proposal.
- The Design-Build Team shall be responsible for all design and construction activities required to provide a continuous eight-lane divided facility from the northern end of the I-2511CB Project to the end of the I-2304AC Project.
- The Design-Build Team shall design and construct the -L- Line such that the full typical section extends to the end of the project. The Design-Build Team shall utilize pavement markings to drop one lane at the NC 150 northbound exit ramp and another lane after the NC 150 interchange.
- Along the -L- Line, the Design-Build Team shall provide a minimum 14-foot outside and median shoulders, 12-foot of which shall be full depth concrete paved shoulders. The median shoulders shall be designed and constructed to accommodate a future travel lane with appropriate cross slope.
- Along the I-85 travel lanes, the Design-Build Team shall provide milled rumble strips along the outside paved shoulders, including acceleration deceleration and auxiliary lanes / ramps to the back of the gore (12-foot width). Along the -L- Line, the Design-Build Team shall provide thermoplastic rumble strips along the median paved shoulders in accordance with the detail provided by the Department.
- The Design-Build Team shall design and construct one-lane ramps that provide a minimum 16-foot lane width. The Design-Build Team shall design and construct two lane ramps that provide minimum 12-foot lanes. All ramps shall have 12-foot inside shoulders, four-foot of which shall be full depth paved shoulders. All ramps shall have 14-foot outside shoulders, four-foot of which shall be full depth paved shoulders and eight-foot of which shall be partial depth paved shoulders.

- The Design-Build Team shall design and construct one-lane loops that adhere to Exhibit 3-51, *Design Widths of Pavements for Turning Roadways*, shown in AASHTO's *A Policy on Geometric Design of Highways and Streets* (2004) - Case II / Condition C. All loops shall have 12-foot outside shoulders, four-foot of which shall be full depth paved shoulders and 2'-6" curb and gutter along the inside edge of pavement, with a 14-foot berm. The minimum loop design speed shall be 30-mph with a minimum 250-foot radius.
- As shown on the I-2511CB Final Plans and I-2304AA Right of Way Plans, the Design-Build Team shall complete the design and construction of –SR2–. The Design-Build Team shall be responsible for the removal and disposal of all sections of existing –SR2–, including but not limited to pavement structure and drainage features, not incorporated into the final alignment and all associated grading.
- Continuously between the NC 150 Loops -A- and -C-, the Design-Build Team shall design and construct a five-lane section. The NC 150 structure over I-85 shall be in accordance with the July 1, 2004 Revised Structure Recommendations provided by the Department. Within these limits, the outside lanes shall serve as right turn lanes for the aforementioned loops.
- With the exception of Old Trading Ford Road (SR 1285) and the bridge, the Design-Build Team shall remove the Clark Road interchange within the entire limits of the entrance and exit ramps. As a minimum, the Design-Build Team shall remove and dispose of the existing pavement structure and subgrade, and reconstruct the I-85 shoulders. Within the interchange, the Design-Build Team shall provide necessary drainage features and seeding and mulching in accordance with the NCDOT Standards and Specifications. Prior to closing / removing the Clark Road interchange, the Design-Build Team shall complete the -SRD- and -Y7- construction, as shown on the I-2304AA Right of Way Plans. The Clark Road interchange ramps shall be closed to traffic prior to opening the new NC 150 interchange ramps to traffic.
- To accommodate Lexcom's aerial relocation, the Design-Build Team shall rough grade between Station 22+00 -Y1- and Station 50+00 -Y1-, LT.
- The Design-Build Team shall resurface the Wil-Cox Bridge after traffic is shifted to the replacement structure for Bridge #392. Reference Pavement Management Scope of Work.
- The Design-Build Team shall provide access for, design and construct a parking area in the vicinity of the north end of the Wil-Cox Bridge. The parking facility should provide parking for a minimum of four vehicles and be compliant with all ADA requirements.
- In accordance with Congestion Management's guidelines, the Design-Build Team shall be responsible for capacity analyses for turn lane lengths and lane configurations at intersections and ramp / loop terminals. All intersection turn lane lengths shall meet the current NCDOT standards where vehicle storage does not govern or the

recommendations of the aforementioned capacity analyses, whichever is greater. This determination shall be made by calculating the recommended treatment for turn lanes, incorporating the minimum deceleration lengths, as defined in the NCDOT Design Manual (Reference Section 9-1, Figure F-4A) and comparing the calculated values with the minimum turn lane lengths.

- The design vehicle for all turning movements shall be a **WB-65**.
- The Design-Build Team shall design and construct all lane drops from the outside roadway.
- The Design-Build Team shall be responsible for the sound barrier wall design and construction listed in the August 2009 Final Design Noise Report, including any geotechnical investigations necessary to design the foundations. The Design-Build Team shall design and construct either Noise Wall #1 Alignment or Noise Wall #2 Alignment as described in the Final Design Noise Report dated August 2009. The Design-Build Team shall be responsible for the wall envelope details. If the Design-Build Team revises the horizontal and / or vertical alignments such that greater noise impacts are possible on surrounding receptors, the Design-Build Team shall re-analyze and complete a revised noise report, if necessary, for NCDOT and FHWA review and acceptance. The August 2009 Final Design Noise Report will be provided to the Design-Build Team to assist in their determination of anticipated additional noise impact on current receptors due to a design change. If adjustments to, or addition of, sound barrier walls are required as a result of design deviations, the Design-Build Team shall be responsible for all costs associated with the adjustments and / or additions.
- Unless noted otherwise elsewhere in this RFP, the Design-Build Team shall design and construct -Y- Lines, ramps, service roads and cul-de-sacs, providing the same or better access, widening and improvements included in the I-2304AA Right of Way Plans. The limits of -Y- Line and service road construction shall be of sufficient length to tie to existing based upon the current NCDOT guidelines and standards.
- Functional classifications that have a defined usable shoulder width shall have the appropriately wider overall shoulder width.
- The I-2304AC Project is a full control of access facility. The Department will acquire all right of way, easements and control of access required for the Department's preliminary design. The Design-Build Team shall bring to the Transportation Program Management Director's attention any deviations from the proposed control of access shown on the I-2304AA Right of Way Plans. The Design-Build Team shall provide all services and costs required for acquiring all additional right of way, easements and / or control of access, including but not limited to direct payments to property owners for negotiated settlements, recording fees, relocation benefits, and deposits and fees involved with filing of condemnation, resulting from design revisions and / or construction methods. If required, parcel names and deed research descriptions shall be the responsibility of the Design-Build Team to acquire and process. Prior to negotiating additional right of way,

easement and / or control of access with property owners, the Design-Build Team shall delineate the additional takes on the Right of Way Plans developed by the Design-Build Team for the Department's review and acceptance. The Design-Build Team shall be responsible for coordinating with, and obtaining approval from, the NCDOT for the woven wire fence placement. The Design-Build Team shall be responsible for installation of the woven wire fence.

- The Design-Build Team shall be responsible for the location and installation of all right of way concrete monuments, including right of way already secured by the Department.
- Unless noted otherwise elsewhere in this RFP, all guardrail placement shall be in accordance with the July 2006 NCDOT *Standard Drawings* and / or approved details in lieu of standards. Along the I-85 median, double faced steel beam guardrail shall be used. Along all 3:1 fill slopes, constructed at fill heights that are greater than 12 feet, the Design-Build Team shall install guardrail. Along all fill slopes steeper than 3:1, constructed at fill heights that are equal to or greater and six feet, the Design-Build Team shall install guardrail. The guardrail design shall be submitted for review with the Preliminary Plans submittal.
- All bridges carrying the -L- Line shall have 12-foot bridge rail offsets. The US 29 – US 70 bridge rail offsets shall be four feet.
- The Design-Build Team shall not further impact any cultural, historical, or otherwise protected landmark or topographic feature beyond that shown on the I-2304AA Right of Way Plans. The Design-Build Team shall install protective fence along that portion of the Yadkin River Crossings Historic District boundary adjacent to construction activities. The Design-Build Team shall not utilize the Yadkin River Crossings Historic District for any construction activities including but not limited to material storage, equipment staging, waste site, or borrow pit, however the Design-Build Team may be allowed overnight parking of equipment and storage of materials, associated with current construction needs, within the construction right of way limits along any part of the project corridor. The Design-Build Team shall not disturb the Trading Ford Monument located near the intersection of SR 1138 (Old US 29/70) & SR 1139 (Sowers Road) as shown on the I-2304AA Right of Way Plans as Historic Marker.
- The Design-Build Team shall design and construct resurfacing grades for all roadways impacted by construction, excluding haul roads. At a minimum, the Design-Build Team shall resurface all lanes and shoulders of an undivided facility throughout the limits of proposed widening and construction. At a minimum, the Design-Build Team shall resurface each one-way roadway of a divided facility throughout the limits of the one-way roadway widening and construction, allowing varying resurfacing limits for the opposing directions of travel. At a minimum, for both divided and undivided facilities, the Design-Build Team shall resurface all lanes and shoulders within the outermost construction limits of all proposed widening and construction, including any gaps along the facility where construction activities are not required. Additionally, the Design-Build Team shall resurface all existing facilities to the limits of pavement marking obliterations

/ revisions. The Design-Build Team shall design and construct grades that adhere to the design criteria and standards, providing all required pavement wedging. (Reference the Pavement Management Scope of Work found elsewhere in this RFP)

- Unless noted otherwise elsewhere in this RFP, the maximum allowable cut and fill slope shall be 2:1. (Reference the Geotechnical Engineering Scope of Work found elsewhere in this RFP) The slopes in the interchange areas shall follow the requirements set forth in the *Roadway Design Guidelines for Design-Build Projects* located on the Design-Build web site. Inside the interchange quadrants the maximum slope allowed shall be 4:1.
- The Design-Build Team shall inform the Transportation Program Management Director, in writing, of any proposed changes to the NCDOT preliminary design, previously reviewed submittals or the Design-Build Team's Technical Proposal and obtain approval prior to incorporation. The Design-Build Team shall note in the Technical Proposal any proposed deviations to the preliminary design shown on the I-2304AA Right of Way Plans provided by the Department. The Design-Build Team shall be responsible for any activities, as deemed necessary by the Department or the FHWA, resulting from changes to the NCDOT preliminary design, including but not limited to, public involvement and NEPA re-evaluation. The Department shall not honor any requests for additional contract time or compensation for completion of the required activities resulting from changes to the NCDOT preliminary design.
- Design exceptions shall not be allowed for the proposed eight-lane divided facility, including all ramps and loops. NCDOT prefers not to have design exceptions for the -Y- Lines and service roads. If the Design-Build Team anticipates any design exceptions, they shall be clearly noted in the Technical Proposal. Prior to requesting / incorporating a design exception into the Final Plans, the Design-Build Team shall obtain prior conceptual approval from the Transportation Program Management Director and the FHWA. If approval is obtained, the Design-Build Team shall be responsible for the development and approval of all design exceptions.
- The Design-Build Team shall submit Structure Recommendations and Design Criteria for NCDOT and FHWA review and acceptance prior to submittal of the Preliminary Plans. The Design-Build Team shall develop Structure Recommendations that adhere to the format noted in the March 25, 2003 and September 1, 2004 memos from Mr. Jay Bennett, PE, State Roadway Design Engineer. The design speed for all roadways shall be the greater of the minimum design speed for the facility type or the anticipated / actual posted speed plus five-mph.
- The Design-Build Team shall be responsible for the evaluation of the algebraic difference in rates of cross slope (roll-over) between existing shoulders and roadways and the associated suitability for carrying traffic during construction, if necessary. In the event that the roll-over is found to be unacceptable for the proposed temporary traffic patterns, the Design-Build Team shall be responsible for providing cross slopes that meet design standards and eliminate roll-over concerns.

- Within the vehicle recovery area, the Design-Build Team shall design and construct single face concrete barrier in front of all sound barrier walls located on the outside shoulder in fill sections, retaining walls and all elements acting as a retaining wall.

General

- The design shall be in accordance with the 2004 AASHTO *A Policy on Geometric Design of Highways and Streets*, 2002 NCDOT *Roadway Design Manual*, July 2006 *NCDOT Roadway Standard Drawings* (or as superseded by the details sheets at http://www.ncdot.gov/doh/preconstruct/ps/std_draw/06details/default.html), *Roadway Design Policy and Procedure Manual*, *Roadway Design Guidelines for Design-Build Projects*, 2006 *North Carolina Standard Specifications for Roads and Structures* and the 2002 AASHTO *Roadside Design Guide*, 3rd Edition and 2006 *Chapter 6 Update*.
- If the NCDOT *Roadway Design Manual*, the 2004 AASHTO *A Policy on Geometric Design of Highways and Streets*, the 2006 *Roadway Standard Drawings* and / or any other guidelines, standards or policies have desirable and / or minimum values, the Design-Build Team shall use the desirable values unless noted otherwise elsewhere in this RFP. Similarly, in case of conflicting design parameters, and / or ranges, in the various resources, the proposed design shall adhere to the most conservative values, unless noted otherwise elsewhere in this RFP.
- A sag vertical curve low point shall not be located on any bridge or approach slab.
- The Design-Build Team shall contact Mr. Gary W. Thompson, North Carolina Geodetic Survey Director, prior to disturbing any geodetic monuments.
- The project shall follow the NCDOT-FHWA Oversight Agreement. This agreement shall be provided. Any changes that affect previous approvals shall be re-submitted by the Design-Build Team for FHWA acceptance.
- The Design-Build Team shall identify the need for any special roadway design details (i.e. any special drainage structures, rock embankment, rock plating, special guardrail, retaining walls, concrete barrier designs, etc.) and shall provide special design drawings. The Contracts Standards and Development Unit may have special details available that can be provided to the Design-Build Team upon request.

NCDOT Information Supplied

- The NCDOT will provide copies of the Environmental Assessment (EA), Finding of No Significant Impact (FONSI), Consultation, Section 106 MOA, and the latest list of environmental commitments, municipal agreements and all pertinent approvals and correspondence. Unless noted otherwise elsewhere in this RFP, the Design-Build Team shall adhere to all commitments stated in the environmental documents.

- NCDOT will provide electronic surveys and a coordinate equality for TIP Projects I-2511CB and I-2304AC, excluding As-Built surveys for the newly constructed I-2511CB Project. Any supplemental surveys, including but not limited to additional topography, existing and proposed roadway, structure sites, underground and overhead utilities, existing and proposed drainage, wetland delineation, right of way, parcel names, and deed research and descriptions shall be the responsibility of the Design-Build Team to acquire and process. Known existing utilities have been located and will be included with the survey data. The Design-Build Team shall be responsible for confirming the location of the utilities and the type / size of facilities. All supplemental SUE work shall be the responsibility of the Design-Build Team.
- The NCDOT will provide the I-2511CB Final Plans.
- The NCDOT will provide the I-2304AA Right of Way Plans. The Design-Build Team is cautioned that the preliminary design shown on the plans provided by the Department is provided solely to assist the Design-Build Team in the development of the project design. The Design-Build Team shall be fully and totally responsible for the accuracy and completeness of the project design, including, but not limited to, the use of the NCDOT's design, the use of portions of the NCDOT's design or modifications to the NCDOT's design. The Design-Build Team is also responsible for modifying the Right-of-Way Plans provided by the Department to ensure that the plans meet current design standards.
- The NCDOT will provide a Geotechnical Subsurface Investigation for I-2304AC. The Design-Build Team shall be responsible for any additional geotechnical information, all geotechnical recommendations, as well as supplemental structural and roadway investigations. (Reference the Geotechnical Engineering Scope of Work).
- The NCDOT will provide final pavement designs. The Design Build Team shall be responsible for all temporary pavement designs (Reference the Pavement Management Scope of Work found elsewhere in this RFP)

PAVEMENT MANAGEMENT SCOPE OF WORK (12-21-09)

The pavement design for the mainline and mainline shoulders shall consist of the following:

- 14.0” doweled jointed concrete with 15’ uniform joint spacing
- 3.0” B25.0B
- 1.25” SF9.5A
- Subgrade Stabilization

Subgrade stabilization shall be to a minimum depth of 8 inches for lime and 7 inches for cement. The type of subgrade stabilization and amount of stabilizing agent shall be determined in accordance with the Cement and Lime Stabilization of Subgrade Soils Project Special Provision found elsewhere in this RFP.

Other pavement designs for this project are listed in the table below:

LINE	Surface	Intermediate	Base	ABC
SR2 (SR 2180)	3.0” S9.5B	-----	-----	*10.0”
SRB , Ramps A and C	3.0” S9.5B	3.0” I19.0B	-----	8.0”
Y1 (NC 150)	3.0” S9.5B	3.0” I19.0B	-----	10.0”
Y5, Y6 and Y7	3.0” S9.5B	-----	4.0” B25.0B	-----
Ramp A PDPS and Ramp C PDPS	3.0” S9.5B	-----	-----	*Var.
Loops A and C	3.0” S9.5B	4.0” I19.0B	-----	8.0”
SRD	3.0” S9.5B	2.5” I19.0B	-----	6.0”
SR1139, SR 1290, SR 2124 and cul-de-sacs	3.0” S9.5B	-----	4.0” B25.0B	-----
* Prime coat required over ABC				

For use as ABC on -Y- Lines and service roads, the Design-Build Team may use crushed concrete aggregate if the required specifications can be met. The crushed material shall meet all source approval requirements such as LA Abrasion and Deleterious Substances with the exception of the Sodium Sulfate test requirement, which is waived. For approval as a source, the Producer must have a stockpile containing at least 300 tons of material meeting a NCDOT standard gradation before samples will be obtained by the Materials Inspector for evaluation. For use as ABC, the material must meet the ABC gradation. The Liquid Limit of the material is raised 5 points to a maximum of 35. Material that is transported to a project from an offsite crushing facility shall be subject to the requirements of the Aggregate Quality Control / Quality Assurance Program.

The Design-Build Team shall resurface the -Y- Lines with a minimum pavement depth that equals the full thickness of surface course as provided in the table above. (Reference the Roadway Scope of Work found elsewhere in this RFP)

The Design-Build Team shall mill 1.25” of pavement from the Wilcox Bridge deck (Bridge No. 46) and replace with 1.25” of SF9.5A.

The Design-Build Team shall pave the parking area in the vicinity of the north end of the Wil-Cox Bridge (Bridge No. 46) with a minimum of 4.0"ABC, and one layer of SF9.5A surface course. (Reference the Roadway Scope of Work found elsewhere in this RFP.).

On all ramps and loops, the adjacent through lane pavement design shall extend to the back of the gore (12-foot width).

The Design-Build Team shall completely remove and dispose of the entire pavement structure, including shoulders, within the reconstruction limits of I-85. In areas where the existing -Y-Line paved shoulders are proposed to be incorporated into a permanent travel lane, the Design-Build Team shall be responsible for evaluating the existing paved shoulder regarding its suitability for carrying the projected traffic volumes. In the event that the existing paved shoulder is found inadequate, the Design-Build Team shall be responsible for upgrading the existing paved shoulder to an acceptable level or replacing the existing paved shoulder. The Design-Build Team shall submit their evaluation and proposed use of existing paved shoulders to the Transportation Program Management Director for review and acceptance or rejection.

The Design-Build Team shall be responsible for the design of all temporary pavements and for evaluation of existing shoulders and roadways regarding their suitability for carrying traffic during construction, if necessary. In the event that the existing shoulders and roadways are found to be inadequate for the proposed temporary traffic volumes and duration, the Design-Build Team shall be responsible for upgrading the pavement to an acceptable level. Temporary pavements shall be designed in accordance with the most recent version of the North Carolina DOT Pavement Design Procedure. Temporary pavement designs shall be submitted for review and comment using the contract submittal process. The expected duration for traffic on temporary pavement must be included as part of the submittal. (Reference the Roadway Scope of Work found elsewhere in this RFP)

All driveways, up to the radius point, shall be constructed with the full-depth pavement design of the intersecting roadway. The entire impacted length of all non-concrete driveways with a 10% or steeper grade shall be constructed with 1.5" S9.5B and 8" ABC. Unless otherwise noted above, the Design-Build Team shall adhere to the following for all driveway construction:

For existing gravel and soil driveways, use 8" ABC.

For existing asphalt driveways, use 1.5" S9.5B and 8" ABC.

For existing concrete driveways, use 6" jointed concrete reinforced with woven wire mesh.

In areas where the Design-Build Team's design requires an existing paved facility to accommodate projected traffic volumes other than the Department's projected traffic volumes, the Design-Build Team shall evaluate the existing paved facility regarding its suitability for carrying the Design-Build Team's projected traffic volumes. In the event that the existing paved facility is found to be inadequate, the Design-Build Team shall be responsible for upgrading the existing paved facility to an acceptable level or replacing the existing paved facility. Prior to incorporation, the Design-Build Team shall submit their evaluation and proposed use of the existing paved facility to the Transportation Program Management Director for review and acceptance or rejection.

The rate of application and the maximum and minimum thickness per application and layer shall be in accordance with the NCDOT Roadway Design Manual.

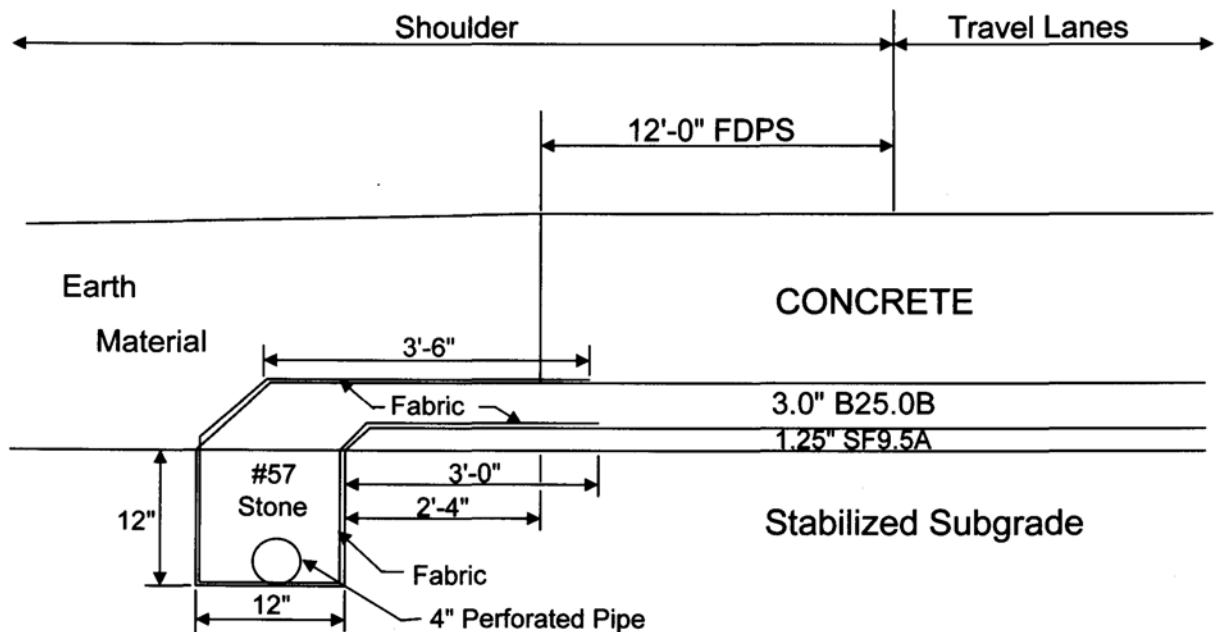

Shoulder drains are required for **this project**. The detail for construction of the shoulder drains is shown above.

The Design-Build Team shall be responsible for the design and construction of shoulder drains and outlets for the mainline. Shoulder drains shall be provided on the low side of cross slopes and / or superelevation throughout all vertical curves, and / or where the grade is less than 1%. Where installed on the median shoulder, outlets shall be provided at every drainage structure. Where installed on the outside shoulder, outlets shall be provided approximately every 300 feet. Shoulder drains shall be placed to drain the entire pavement structure. The preliminary locations of shoulder drain installations for this project, as required by the Department's Right of Way Plans, are listed in the table below. At a minimum, the Design-Build Team shall verify that the shoulder drain locations and outlets below provide adequate drainage; and install those shoulder drains and outlets as required by design.

LINE	SIDE	Begin Station	End Station	OUTLET LOCATIONS
-L-	NBL, Outside	807+00	820+00	811+76(3GI), 813+00(3GI), 813+71±, 816+00
-L-	NBL, Outside	828+94	836+00	828+94(2GI), 832+00(2GI)
-L-	NBL, Outside	843+60	851+00	847+00(2GI), 849+10(2GI), 851+00
-L-	NBL, Outside	864+00	868+45	867+00±(2GI), 867+50(2GI)
-L-	NBL, Outside	898+50	907+00	898+50(2GI), 899+76(2GI), 902+50,

				905+50(2GI)
-L-	NBL, Outside	921+00	924+56	924+56(2GI)
-L-	NBL, Outside	925+00	926+47	926+47(2GI)
-L-	NBL, Outside	928+00	937+50	932+00, 936+00(2GI), 937+50(JB)
-L-	NBL, Outside	946+00	980+00	949+60(2GI), 952+05(2GI), 953+99±, 956+50, 959+50, 963+00, 964+27(2GI), 965+50(2GI), 969+50, 973+50(2GI), 974+50(2GI), 977+50
-L-	SBL, Outside	807+00	820+00	811+00, 813+71± , 816+43(2GI)
-L-	SBL, Outside	828+94	836+00	828+94(2GI), 832+00(2GI)
-L-	SBL, Outside	840+00	850+50	842+00(2GI), 844+50(2GI), 847+00(2GI), 849+10(2GI), 850+50(2GI)
-L-	SBL, Outside	864+00	868+00	866+80± (2GI)
-L-	SBL, Outside	897+65	909+00	897+65(2GI), 898+65(2GI), 902+00, 905+50(2GI)
-L-	SBL, Outside	921+00	924+70	924+70(2GI)
-L-	SBL, Outside	925+00	932+61	928+50(2GI), 928+96(2GI), 931+00(2GI), 932+61(2GI)
-L-	SBL, Outside	936+00	944+25	939+50(2GI), 942+00(2GI), 944+25(2GI)
-L-	SBL, Outside	946+15	959+70	947+50(2GI), 951+30(2GI), 953+99± , 956+60(2GI)
-L-	SBL, Outside	964+50	977+00	964+50, 967+50, 970+50, 973+50(2GI)
-L-	NBL & SBL, Median	810+00	820+00	813+86± (2GI), 816+43(2GI)
-L-	NBL & SBL, Median	828+94	836+00	828+94(2GI), 832+00(2GI)
-L-	NBL & SBL, Median	843+00	849+10	847+00(2GI), 849+10(2GI)
-L-	NBL & SBL, Median	864+00	868+45	866+89± (2GI)
-L-	NBL & SBL, Median	897+80	901+00	897+80(2GI)
-L-	NBL & SBL, Median	939+00	968+00	942+00(2GI), 944+25(2GI), 949+60(2GI), 954+00± (2GI), 959+45(2GI), 964+29(2GI)

Note: **Station±** : indicates vertical sag which has two outlets. (Ex. 813+71±)

The Design-Build Team shall pave from the edge of the proposed paved shoulder to the face of sound barrier walls located on the outside shoulder in fill sections and all guardrails with 6" of ABC (or 4" B25.0B or B25.0C), a split seal and at least one lift of surface course. If a split seal is not used, the ABC pavement design shall require prime coat at the normal application rate. In these areas, the Design-Build Team's installation of ABC or black base shall be consistent with the pavement type for the specific roadway. As an alternative to the aforementioned pavement design for paving the shoulders to the face of guardrail, the Design-Build Team may use the travel lane pavement design.

STRUCTURES SCOPE OF WORK (12-21-09)

Project Details

The Design-Build Team shall be responsible for the design and construction of all structures necessary to complete the project, including the following:

- Dual Bridges on I-85 over the Duke Power Industrial Rail Spur and SR 2124 (Hackett Road)
- Dual Bridges on I-85 over Yadkin River, surrounding wetlands, and Norfolk Southern RR
- Replace Bridge #392 on -SRB- (US29-70) over the Yadkin River
- Bridge on -Y1- (NC150) over I-85
- Noise Wall along -L- and -SRB-. Reference Final Design Noise Report dated August 2009.
- Modifications to the existing rails on Bridge #46 on US29-70 over the Yadkin River to safely accommodate pedestrian and bicycle traffic. The height of the rails shall be 54" minimum after modification. Existing scuppers shall also be patched prior to resurfacing of the bridge (Reference Pavement Management Scope of Work).

The barrier rail for the replacement bridge for Bridge #392 shall be a New Jersey style barrier with an aesthetic treatment on the non-traffic face similar in appearance to the railing on the retained Bridge #46 and the detail provided by the Department. All other bridge barrier rails shall be jersey shaped barriers per Standard Drawing CBR1.

The empirical method of deck design will not be allowed.

A load rating summary for girders will be required on the bridge plans. The load rating shall be in accordance with the August 21, 2009 LRFR Load Factors memo and AASHTO's Manual for Bridge Evaluation.

The minimum vertical clearance required for bridges over I-85 is 17'-0". Bridges over railroads shall provide the minimum clearances shown on the preliminary general drawings associated with the railroad agreements secured by the Department. All minimum vertical clearances shall allow for provision of future I-85 widening to the median.

The Design-Build Team shall include in their Technical Proposal any non-standard bridge types. These designs will be subject to NCDOT and FHWA review and approval. The Technical Proposal shall also address any design features to accommodate maintenance of the structures and any specialized inspectors that will be employed during construction of bridges.

Cored slab, AASHTO box girders, steel tub girders, deck girders, fracture critical bridges, and cast-in-place deck slab bridges will not be allowed.

The bridge design crossing Norfolk Southern tracks shall accommodate the existing two mainline tracks as well as the realignment of the two mainline tracks and a third future freight track. It shall also accommodate two potential alignments for a future high speed track. Reference the preliminary plans associated with the railroad agreements secured by the

Department for clearances required to accommodate these existing, potential, and future alignments. The South end of the bridge shall be located such that all fill is located outside of the delineated wetlands.

Bridge Removal:

The Design Build Team is responsible for the removal and disposal of all bridges removed from service including:

- Rowan County Bridges #135 and #136 (I-85 NB and SB over Hackett Road, SR2124)
- Rowan County Bridge #137 (NB and SB I-85 over the Yadkin River)
- Rowan County Bridge #392 (US29-70 over the Yadkin River)
- Davidson County Bridges #18 and #22 (NB and SB I-85 over Southern Railroad)
- Davidson County Bridge #20 (NC150 over I-85)
- Davidson County Bridge #41 (I-85 SB over US29/70)

Removal of all structures over water shall be in accordance with *Section 402* of the 2006 *NCDOT Standard Specifications for Roads and Structures, NCDOT Best Management Practices for Bridge Demolition, environmental permit conditions*, and shall use sawing or other approved non-shattering methods. Remove existing substructures / foundations to the streambed elevation at the time of removal. No blasting will be allowed in the Yadkin River. Underwater sawing or other approved non-shattering methods will be required to accomplish substructure removal and limit streambed disturbance. Saw cuttings are considered part of the structure. Saw slurry must be contained. The current environmental permit application allows for work bridge access to remove and construct Bridge #392 and construct I-85 bridges over Yadkin River. The Design-Build Team is responsible for preparing any permit modifications needed to obtain access for removal of I-85 bridge over Yadkin River.

Bridges 135, 136, 137 and 392 in Rowan County and Bridges 18, 20, 22, and 41 in Davidson County all have paint systems containing red lead paint. The Design-Build Team is responsible for handling, removing, shipping, and disposing of these materials in accordance with the 2006 *NCDOT Standard Specifications for Roads and Structures*.

Temporary Work Bridges:

Submit details of all temporary work bridges to the Engineer for review and approval prior to constructing. Make certain that the temporary work bridge satisfies all permits. If the Design-Build Team proposes to use a method other than a temporary work bridge, the Design-Build Team shall coordinate with and obtain approval from the agencies prior to incorporating the alternate construction method.

A channel opening in the Yadkin River is required at all times and must provide a minimum of 50 feet of horizontal clearance. The Design Build-Team shall investigate the vertical clearance necessary if this channel opening is spanned by the temporary work bridge. The channel span shall provide enough vertical clearance to allow for uninterrupted boat traffic. The Design-Build Team shall be responsible for preparing all documents necessary for environmental agency notification or permit modification that may be necessitated by closing this channel span. The

Design-Build Team shall be fully responsible for any markings, signing, buoys, etc. to ensure safe boat traffic around and beneath all temporary work bridges. Completely remove the temporary work bridge prior to final acceptance or as otherwise required by the permits.

General

The Team's primary design firm shall be on the Highway Design Branch list of firms qualified for Structure Design and maintain an office in North Carolina.

All bridges shall meet approved Roadway typical sections and grades. Bridge geometry (width, length, skew, span arrangement, etc.) shall be in accordance with the approved Structure Recommendations and Bridge Survey Reports.

Design shall be in accordance with *AASHTO* LRFD Bridge Design Specifications, NCDOT LRFD Driven Pile Foundation Design Policy, NCDOT Structure Design Manual (including policy memos), NCDOT Bridge Policy Manual, Norfolk Southern Corporation's "Guidelines for the Design of Grade Separation Structures", Duke Power and Norfolk Southern Corporation special provisions and State-Railroad Agreements, and *AREMA Manual for Railroad Engineering*.

Construction and materials shall be in accordance with the 2006 *NCDOT Standard Specifications for Roads and Structures*, NCDOT Structure Design Unit Project Special Provisions, NCDOT Structure Design Unit Standard Drawings, Norfolk Southern Corporation (NSC) Special Provisions and State-Railroad Agreements.

Attachment of sign structures to bridges shall not be allowed. Monotube sign supports shall not be allowed.

Shoulder piers for grade separation structures will not be allowed.

Any required bridge attachments (e.g. ITS conduit, water lines) will not be allowed in the overhang of grade separations. Casting of conduit in the bridge deck or railing will not be allowed.

Sound barrier walls shall be in accordance with Standards SBW1 and SBW2 and the Sound Barrier Wall Project Special Provision located on the Structure Design Unit web site or alternate details and special provisions approved by the NCDOT Structure Design Unit, Geotechnical Engineering Unit and Human Environment Unit.

Alternate designs, details, or construction practices (such as those employed by other states, but not standard practice in NC) are subject to Department review and shall be evaluated on a case by case basis.

I. GENERAL:

Obtain the services of a firm prequalified for geotechnical work by the Highway Design Branch List. The prequalified geotechnical firm shall prepare foundation design recommendation reports for use in designing structure foundations, roadway foundations, retaining walls, sound barrier foundations, overhead sign structure foundations, overhead sign structures, and temporary structures.

The Engineer of Record who prepares the foundation design recommendation reports shall be a Professional Engineer registered in the State of North Carolina who has completed a minimum of three geotechnical design projects of scope and complexity similar to that anticipated for this project using the load and resistance factor design (LRFD) method and in accordance with the latest edition of the AASHTO *LRFD Bridge Design Specification*. If the Engineer of Record cannot demonstrate the aforementioned LRFD experience, then the design must undergo a peer review by an individual with such experience. In such case, the reviewer must be a registered Professional Engineer, but not necessarily in the State of North Carolina. Prior to the first geotechnical design submittal, the Design-Build Team shall provide a letter to the NCDOT Design-Build Office that documents the reviewer's LRFD experience for review and acceptance. Furthermore, with each geotechnical design submittal, the reviewer shall provide a sealed letter stating that he / she has carefully reviewed and approved the specific submittal details.

The prequalified geotechnical firm shall also determine if additional subsurface information, other than that required and noted elsewhere in this RFP, is required based upon the subsurface information provided by the NCDOT and the final roadway and structure designs. If a determination is made that additional subsurface information is required; the Design-Build Team shall use a prequalified geotechnical firm to perform all additional subsurface investigation and laboratory testing in accordance with the current NCDOT Geotechnical Engineering Unit *Guidelines and Procedures Manual for Subsurface Investigations*. Submit additional information collected by the Design-Build Team to the Geotechnical Engineering Unit for review. The Design-Build Team shall provide the final Subsurface Investigation report in electronic and hardcopy format to the NCDOT for its records.

A minimum of 2 standard penetration test (SPT) / rock core borings shall be required per bent for all bridges except dual bridges. A minimum of 3 SPT / rock core borings shall be required across the roadway typical section, at each bent location for dual bridges. All borings shall be located within 100 feet of the centerline of each bent location to be counted for these minimum requirements. Extend all borings to a depth below the foundation element that is twice the diameter of the foundation element required to show a complete subsurface profile. The Design-Build Team shall be responsible for obtaining the borings noted above for all bents where subsurface information is not sufficient or is warranted by variability in the geology unless the prequalified geotechnical firm submits documented justification that the subsurface investigation provided by the NCDOT is

adequate for design purposes and the justification is acceptable to the Department. The Design-Build Team shall present any proposed deviation from these requirements in the Technical Proposal. Any deviations to the requirements noted above shall require acceptance from the NCDOT Geotechnical Engineering Unit prior to construction.

The maximum spacing between borings for retaining walls and sound barrier walls shall be 200 feet, with a minimum of two borings; one at each end of the wall. Drill borings for retaining walls to twice the maximum height of the wall. Boring depths for sound barriers shall be equal to the maximum height of the wall or to SPT refusal.

The Design-Build Team is permitted to design bridges on this project using software that accounts for the structural effects of soil / pier interaction.

II. DESCRIPTION OF WORK:

The Design-Build Team shall design foundations (except sign foundations), embankments, slopes, retaining walls, and sound barriers in accordance with the current edition of the AASHTO *LRFD Bridge Design Specifications*, NCDOT *LRFD Driven Pile Foundation Design Policy*, all applicable NCDOT Geotechnical Engineering Unit Standard Provisions, NCDOT *Structure Design Manual*, and NCDOT *Roadway Design Manual*. The NCDOT *LRFD Driven Pile Foundation Design Policy* is located on the NCDOT Geotechnical Engineering Unit's website at:

[www.ncdot.org/doh/preconstruct/highway/geotech/LRFD Driven Pile Foundation Design Policy.pdf](http://www.ncdot.org/doh/preconstruct/highway/geotech/LRFD_Driven_Pile_Foundation_Design_Policy.pdf)

For *Geotechnical Guidelines For Design-Build Projects*, the Design-Build Team shall adhere to the guidelines located at the following website:

http://www.ncdot.org/doh/preconstruct/altern/design_build/default.html

A. Structure Foundations

Key in spread footings of structures crossing streams a minimum of full depth below the 100-year design scour elevation and provides scour protection in accordance with scour protection detail in the NCDOT *Structure Design Manual*.

Permanent steel casings shall be required for drilled piers that are constructed in six inches or more of water. Permanent steel casings are required for drilled piers constructed on sloped stream banks subject to degradation from flooding.

When the weathered rock or rock elevation is below the 100-year hydraulic scour elevation, the 100-year and 500-year design scour elevations are equal to the 100-year and 500-year hydraulic scour elevations from the structure survey report accepted by the NCDOT Hydraulics Unit. When the weathered rock or rock elevation is above the 100-year hydraulic scour elevation, the 100-year design scour elevation may be considered equal to the top of the weathered rock or rock

elevation, whichever is higher, and the 500-year design scour elevation may be set two feet below the 100-year design scour elevation.

End bent fill slopes up to 35 feet in height (defined as the difference between grade point elevation and finished grade at toe of slope) shall be 1.5:1 (H:V) or flatter. End bent fill slopes with heights greater than 35 feet shall be 2:1 or flatter. All end bent cut slopes shall be 2:1 or flatter. For 1.5:1 fill slopes, extend end bent slope protection from the toe of slope to berm and to 1.75:1 (H:V) slope or to the limits of the superstructure. For cut slopes and for 2:1 or flatter end bent fill slopes, extend end bent slope protection from the toe of slope to berm and to the limits of the superstructure.

Analyze drilled pier and pile bent foundations using either L-Pile or FB-Pier. Design drilled piers and vertical piles with a sufficient embedment in soil and/or rock to achieve “fixity”.

B. Roadway Foundations

Unless otherwise noted herein, all unreinforced proposed fill slopes shall be 2:1 (H:V) or flatter except bridge end bent slopes (see Section A – Structure Foundations). All proposed soil cut slopes shall be 2:1 (H:V) or flatter, unless the slopes are designed with adequate reinforcement to provide the required stability. If steeper than 2:1 (H:V), all reinforced cut slopes, rock cuts and fill slopes may only be used if detailed design calculations and a slope stability analysis are submitted to the NCDOT Geotechnical Engineering Unit, via the Transportation Program Management Director, for review and acceptance prior to construction.

Design sound barrier foundations in accordance with current allowable stress design AASHTO *Guide Specifications for Structural Design of Sound Barriers*. A minimum factor of safety of 1.5 shall be required for shaft embedment depths.

Design and construct bridge approach embankments such that no more than 2 inches of settlement shall occur after the waiting periods end. Soil improvement techniques to mitigate long term settlement problems or to transfer the embankment load to a deeper bearing stratum are allowed. Soil improvement techniques shall follow the current industry standard practices and the guidelines of *Ground Improvement Methods FHWA publication NHI-04-001* or *Geosynthetic Design and Construction Guidelines FHWA-HI-95-038*.

Embankment settlement monitoring shall be required when a waiting period of more than one month is recommended in the foundation design recommendation reports. Use an appropriate method to monitor settlement across the length of the embankment (from toe to toe) such as settlement gauges, surveyed stakes on finished subgrade or other methods but submit documentation describing the method and procedures to the NCDOT Geotechnical Engineering Unit, via the Transportation Program Management Director, for review and acceptance prior to construction of the embankment.

Reinforced bridge approach fills in accordance with the NCDOT standard shall be required for end bents on all bridges.

C. Permanent Retaining Wall Structures

For design and construction of mechanically stabilized earth (MSE) retaining walls, refer to the NCDOT Policy for Mechanically Stabilized Earth Retaining Walls which can be found at the NCDOT Geotechnical Engineering Unit's website at:

http://www.ncdot.org/doh/preconstruct/highway/geotech/msewalls/07-12-18_MSE_Retaining_Walls_Policy.pdf

Design and construct permanent retaining walls, with the exception of gravity walls, in accordance with the applicable NCDOT Geotechnical Engineering Unit *Project Special Provisions*, which can be provided upon request by the Design-Build Team. Geotechnical Provisions and Notes can be found at the NCDOT Geotechnical Engineering Unit's website at:

<http://www.ncdot.org/doh/preconstruct/highway/geotech/provnote/>

For each retaining wall, with the exception of gravity walls, submit a wall layout and design. The wall layout submittal shall include the following:

- Wall envelope with top of wall, bottom of wall, existing ground and finished grade elevations at incremental stations.
- Wall alignment with stations and offsets.
- Typical sections showing top and bottom of wall, drainage, embedment, slopes, barriers, fences, etc.
- Calculations for bearing capacity, global stability and settlement.
- Details of conflicts with utilities and drainage structures.
- Roadway plan sheets showing the wall (half size).
- Roadway cross sections showing the wall (half size).
- Traffic control plans showing the wall (half size).

Gravity walls shall be designed and constructed in accordance with the NCDOT Structure Standard Drawings and the NCDOT *2006 Standard Specifications*. Gravity walls shall be identified in the roadway foundation design recommendation report. Cast-in-place cantilever walls shall be designed and constructed in accordance with the NCDOT *2006 Standard Specifications*. Conceptual wall layouts and wall designs shall be submitted for NCDOT for review and acceptance.

Locate retaining walls at toe of slopes unless restricted by right of way limits. The Design-Build Team shall submit global stability calculations for slopes at

retaining walls and obtain acceptance from the NCDOT prior to construction. Any slopes behind walls shall be 2:1 (H:V) or flatter.

Drainage over the top of retaining walls shall not be allowed. Sags in the top of walls are not permissible. Direct runoff above and below walls away from walls, if possible, or collect runoff at the walls and transmit it away. Curb and gutter or cast-in-place single faced barrier with paving up to the wall shall be required when runoff can not be directed away from the back or front of the wall. A paved concrete ditch with a minimum depth of six inches shall be required at the top of walls when slopes steeper than 6:1 (H:V) intersect the back of walls.

Precast or cast-in-place coping shall be required for walls without a cast-in-place face with the exception of when a barrier is integrated into the top of the wall. Extend coping or cast-in-place face a minimum of six inches above where the finished or existing grade intersects the back of the wall. A fence shall be required on top of the facing, coping or barrier or immediately behind the wall, if there is no slope behind the wall.

Deep foundations shall be used for end bents when abutment retaining walls are employed. When using abutment retaining walls, design and construct the end bent and the wall independent of each other. When using abutment retaining walls, the end bent foundation shall be designed and constructed with one of the following deep foundations: (1) a single row of plumb piles with brace piles battered toward the wall, (2) a single row of plumb piles with MSE reinforcement strapped to the back of the cap, (3) a double row of plumb piles or (4) drilled piers. If fill is required around piles or drilled piers, install foundations before placing any fill. Wing walls independent of abutment retaining walls shall be required unless accepted otherwise by the NCDOT. Do not consider lateral support from any fill placed around drilled piers behind abutment retaining walls when analyzing end bent stability. All pile foundations for end bents with abutment retaining walls shall penetrate minimum 10 feet into natural ground. For bearing piles behind such retaining walls, the penetration can be reduced to 5 feet below the bottom of the wall provided the Design-Build Team analyzes and determines that the vertical piles are “fixed” in natural ground such that the decrease in pile embedment shall not significantly increase the top deflection under lateral loading. The calculations and supporting documentation for this analysis shall be submitted to the NCDOT for review and acceptance prior to construction.

D. Temporary Structures

Design temporary retaining structures, which include earth retaining structures and cofferdams, in accordance with current allowable stress design AASHTO *Guide Design Specifications for Bridge Temporary Works* and the *Temporary Shoring Special Provision*. The only submittal required to use the standard sheeting design is the “Standard Shoring Selection Form”.

Design and construct temporary retaining walls in accordance with the applicable NCDOT *Project Special Provision* available upon request by the Design-Build

Team. Traffic Control barrier on top of walls shall be in accordance with the NCDOT Work Zone Traffic Control Unit details available upon request by the Design-Build Team. If anchored barrier is required, then anchor the barrier in accordance with NCDOT *2006 Roadway Standard Drawing* Detail No. 1170.01.

III. CONSTRUCTION REQUIREMENTS:

All construction and materials shall be in accordance with the NCDOT *2006 Standard Specifications* and current NCDOT *Project Special Provisions* unless otherwise stated in this scope of work. The Design-Build Team shall be responsible for investigating, proposing and incorporating remedial measures for any construction problems related to foundations, retaining walls, subgrades, settlement, slopes, and construction vibrations. The NCDOT Geotechnical Engineering Unit shall review and accept these proposals.

The Design-Build Team shall be responsible for any damage or claim caused by construction, including damage caused by vibration (see Article 107-15 NCDOT *2006 Standard Specifications for Roads and Structures*). The Design-Build Team shall be responsible for deciding what, if any, pre and post-construction monitoring and inventories need to be conducted to satisfy their liability concerns. Any monitoring and inventory work shall be performed by a qualified private engineering firm experienced in the effects of construction on existing structures.

The prequalified geotechnical firm that prepared the foundation designs shall review the embankment settlement monitoring data a minimum of once a month and issue a letter prior to releasing the embankment from the waiting period. Waiting periods may not be ended until less than 0.10 inches of settlement is measured over a period of four weeks. Submit the settlement monitoring data to the Transportation Program Management Director prior to issuing the release letter.

The prequalified geotechnical firm that prepared the foundation designs shall review and approve all pile driving hammers and drilled pier construction sequences. After the prequalified geotechnical firm has approved these submittals, the Design-Build Team shall submit to the NCDOT for review prior to beginning construction.

Perform hammer approvals with GRLWEAP Version 2002 or later and in accordance with the NCDOT *2006 Standard Specifications*. Provide pile driving inspection charts or tables for all approved pile hammers.

Limit driving stresses in accordance with the AASHTO *LRFD Bridge Design Specifications*. If a tip elevation is noted on the plans, drive piles to the minimum required driving resistance and tip elevation. Otherwise, drive piles to the minimum required driving resistance and a penetration into natural ground of at least 10 ft.

Unless otherwise approved, stop driving piles when refusal is reached. Refusal is defined as 240 blows per foot or any equivalent set.

Perform Pile Driving Analyzer (PDA) testing to develop pile driving inspection charts or tables. Provide PDA testing, and pile driving inspection charts or tables by a NCDOT pre-approved company. Analyze data with the Case Pile Wave Analysis Program (CAPWAP), version 2006 or later. At a minimum, analysis is required for a hammer blow near the end of initial drive and for each restrike and redrive. Additional CAPWAP analysis may be required as determined by the Engineer.

Meet the guidelines for NCDOT PDA reports from the Geotechnical Engineering Testing Contract for PDA test reports. To obtain a list of pre-approved Geotechnical Engineering Testing Contract companies to perform PDA testing and guidelines for PDA test report, contact the Geotechnical Engineering Unit at 919-250-4088. PDA testing may be performed by a technician, but PDA testing must be overseen and the reports sealed by a Professional Engineer registered in the State of North Carolina. Submit a complete PDA report sealed by the professional engineer who performed the test to the foundation design firm. The foundation design firm shall develop pile driving inspection charts or tables for acceptance by the NCDOT prior to pile installation.

For each permanent bridge that includes driven pile bents or driven pile footings, perform a minimum of one (1) PDA test (dual bridges are counted as one structure) for each pile size, pile type (material or shape) and pile driving hammer combination. Additional PDA tests may be required based upon the AASHTO LFRD *Bridge Design Specifications*. If the bridge length with driven pile foundation is longer than 400 feet, perform additional PDA test at every 400 feet interval. Provide additional PDA testing for any revisions to pile type, size or hammer previously approved. The locations of specific piles to be tested must be accepted by the NCDOT prior to any PDA test. Perform PDA tests in accordance with ASTM D 4945-89, Standard Test Method for High Strain Dynamic Testing of Piles and this scope of work.

For drilled-in piles, the following additional requirements apply:

1. Prequalification of contractors is not required for pile excavation or drilled-in pile holes that are 30 inches in diameter or less.
2. Use Class A Concrete in accordance with Article 1000-4 of the NCDOT *2006 Standard Specifications for Roads and Structures* except as modified herein. Provide concrete with a slump of 6 to 8 inches. Use an approved high-range water reducer to achieve this slump. Perform pile excavation to specified elevations shown on the plans. Excavate holes with diameters that will result in at least 3 inches of clearance all around piles. Before filling holes, support and center piles in excavations and when noted on the plans, drive piles to the required driving resistance. Remove any fluid from excavations and fill holes with concrete.
3. Blasting for core removal is only permitted when approved by the Engineer. Dispose of drilling spoils in accordance with Section 802 of the NCDOT *2006 Standard Specifications for Roads and Structures* and as directed by the Engineer. Drilling spoils consist of all excavated materials including fluids removed from excavations by pumps or drilling tools. If unstable, caving or sloughing soils are anticipated or encountered, stabilize excavations with either slurry or steel casing.

When using slurry, submit slurry details including product information, manufacturer's recommendations for use, slurry equipment details and written approval from the slurry supplier that the mixing water is acceptable before beginning drilling. When using steel casing, use either the sectional type or one continuous corrugated or non-corrugated piece. Steel casings should consist of clean watertight steel of ample strength to withstand handling and driving stresses and the pressures imposed by concrete, earth and backfill. Use steel casings with an outside diameter equal to the hole size and a minimum wall thickness of ¼ inch.

4. Check the water inflow rate at the bottom of holes after all pumps have been removed. If the inflow rate is less than 6 inches per half hour, remove any fluid and free fall concrete into excavations. Ensure that concrete flows completely around piles. If the water inflow rate is greater than 6 inches per half hour, propose and obtain acceptance of a procedure for placing concrete before filling holes. Place concrete in a continuous manner and remove all casings.

Use current NCDOT inspection forms for drilled piers available on the NCDOT Geotechnical Engineering Unit's webpage. Construct and inspect drilled piers in accordance with the NCDOT *Drilled Piers Special Provision* except the Design-Build Team shall inspect drilled piers using their Shaft Inspection Device (SID) for any pours using the wet method of concrete placement and for any drilled pier excavations that have remained open greater than 24 hours. Install Crosshole Sonic Logging (CSL) tubes in all drilled piers. CSL testing shall be required for all the drilled piers for each bridge. After the prequalified geotechnical firm has approved these submittals, submit CSL test information and results to NCDOT to determine if the results are acceptable.

The prequalified geotechnical firm that prepared the original design shall perform any changes to the foundation designs. All changes shall be based upon additional information, subsurface investigation and / or testing. Drilled pier tip elevations shall not be changed during construction unless the prequalified geotechnical firm that prepared the bridge foundation design redesigns the drilled pier from either an SPT / rock core boring, performed in accordance with ASTM standards at the subject pier location, or observations of the drilled pier excavation. If a drilled pier is designed based on a boring, do not drill a boring inside an open drilled pier excavation. Locate the boring within three pier diameters of the center of the subject pier and drill to a depth of two pier diameters below the revised tip elevation. If a drilled pier is redesigned based upon observations of the drilled pier excavation, the geotechnical engineer of record shall be present during the excavation to determine the actual subsurface conditions. Send copies of revised designs including additional subsurface information, calculations and any other supporting documentation sealed by a professional engineer registered in the State of North Carolina to the NCDOT for review.

Conduct proofrolling in accordance with Section 260 of the 2006 *Standard Specifications for Roads and Structures*.

Send copies of any inspection forms related to foundations, settlement or retaining walls to the NCDOT for review.

HYDRAULICS SCOPE OF WORK (12-21-09)

The Design-Build Team shall be required to do the following:

- Employ a private engineering firm to perform hydraulic design for all work required under this contract. The private engineering firm shall be prequalified for Hydraulic Design work under the Hydraulic Unit's normal prequalification procedures prior to bid submission.
- Hold a pre-design meeting with the Director of Transportation Program Management and Hydraulic Review Engineer upon acceptance of the Preliminary Roadway Plans.
- Storm Drainage Design using Geopak Drainage.
- Design in accordance with criteria provided in the North Carolina Division of Highways *Guidelines for Drainage Studies and Hydraulics Design-1999* and the addendum *Handbook of Design for Highway Drainage Studies-1973*, North Carolina Department of Transportation "Best Management Practices for Construction and Maintenance Activities-2003" and the North Carolina Division of Highways Hydraulics Unit web-site:

<http://www.ncdot.org/doh/preconstruct/highway/hydro/>

- Design such that no sag occurs on any bridge or approach slab. No deck drains will be allowed to discharge directly into the Yadkin River. The I-85 bridge deck drains shall drain to the Hazardous Spill Basins.
- The south end of the I-85 Yadkin River crossing shall be located such that no fill is located within the delineated wetlands.
- Bridge Survey Reports and Culvert Survey Reports shall be submitted for review and acceptance by NCDOT and FHWA.
- Hazardous Spill Basins and maintenance access thereto shall be required at each end of the I-85 crossing over the Yadkin River.
- Stormwater Management Plan using Best Management Practices.
- Provide revised permit impact sheets, forms and all other documents necessary for any modifications to the USACE 404 and 401 permits.
- The Design-Build Team shall design the structures on this project to meet the requirements of the Memorandum of Agreement (MOA) between NCDOT and NC Floodplain Mapping Program (NCFMP) approved March 2009 for the Department's submittal to FEMA. The Department shall review with NCFMP the eligibility for the MOA. No construction activity shall occur in FEMA regulated floodplains until the MOA package has been reviewed. If the Design-Build Team's design can not meet the requirements of the MOA package, then the Design-Build Team shall prepare a CLOMR package. No construction activity shall occur in

FEMA regulated floodplains prior to obtaining an approved CLOMR. The Department will be responsible for all associated fees.

- Prepare LOMR packages for any regulated streams impacted by the design for the Department's submittal to FEMA after the project is completed or after construction in the impacted floodplains is completed. The Department will be responsible for all associated fees.
- Prepare Pre and Post Analyses for increases in discharge and take appropriate action in accordance with the guidelines noted herein to make sure that additional drainage is adequately handled.
- Use a minimum ditch grade of 0.3% and avoid using ditches in wetlands.

I. Traffic Control Plans and Temporary Pavement Marking Plans

A. Design Parameters

The Design-Build Team shall prepare the Traffic Control and Temporary Pavement Marking Plans for this project following the parameters listed below:

1. Maintain a minimum of two 11-foot lanes in each direction on I-85. Maintain 4-foot wide inside and outside shoulders in each direction of I-85 unless temporary barrier is placed on the paved shoulder. Maintain existing lane and shoulder widths on all other roadways.
2. All traffic control devices shall be placed a minimum 2-foot offset (shy distance) from the edge of travel lane.
3. Show temporary barrier system on the Traffic Control Staging Concept. Temporary barrier systems shall be designed in accordance with the following requirements:
 - Perform an Engineering Study to determine the need for temporary barrier that considers clear zone distances, roadway geometry, anticipated construction year traffic volumes, traffic speeds, roadside geometry, workers safety, pedestrian safety, etc. in accordance with FHWA Final Rule on Temporary Traffic Control Devices (23 CFR 630 Subpart K).
 - Provide a motorist breakdown area on the right side of the travel way along -L- (I-85) when temporary barrier is used on both sides of a direction of travel for a distance longer than 2000 feet unless the outside useable shoulder width is eight feet or greater. Additional breakdown areas shall be provided every one (1) mile thereafter. All breakdown areas shall be 1000 foot long and 14 foot wide.
 - The Design-Build Team shall determine, and adhere to, the length of need, flare rate, clear zone and possible deflection of the proposed temporary barrier system in accordance with NCHRP-350 deflections from crash testing.
 - The Design-Build Team shall not place temporary barrier systems utilized for traffic control on unpaved surfaces.
4. The design speed for temporary alignments of NC, US and interstate routes shall not be lower than the current posted speed limit.
5. Use Roadway Standard Drawing 1101.11 for temporary lane closures only. All temporary alignments shall adhere to the *NC DOT Roadway Design Manual*, 2004 *AASHTO A Policy on Geometric Design of Highways and Streets* and the most current *Highway Capacity Manual*.
6. Changes in superelevation rates shall only occur on a lane line and shall not exceed 0.04 between adjacent travel lanes for temporary traffic patterns.
7. Maintain access to all residences, schools, emergency services and businesses at all times.
8. The Design Build Team shall not split traffic traveling in the same direction. (i.e. separation by any type of barrier, bridge piers, existing median, etc.).
9. The Design Build Team shall obtain written approval from the Department for all road closures prior to incorporation.

10. The Design-Build Team shall not place I-85 traffic on an offsite detour. Offsite detours shall only be allowed for US 29-70E and NC 150 (including access to I-85). Prior to incorporation, all offsite detour routes shall receive Department written approval and adhere to the following requirements:
- All detour routes shall be investigated, including but not limited to, analyzing traffic capacity, investigating impacts to emergency services and schools and investigating pavement structural adequacy
 - The Design-Build Team shall determine and provide improvements required to accommodate detoured traffic prior to utilizing detour routes
 - Offsite detours that have non-signalized at-grade railroad crossings shall not be allowed
 - The Design-Build Team shall include all proposed offsite detours in the Technical Proposal and provide justification for using such detours along with duration. Possible detour warrants could include, but are not limited to, road closures due to substandard horizontal or vertical clearance limits, grade changes at tie-in locations and oversize and / or overweight limits.
 - Submit the detour route and all associated sign designs for review and acceptance prior to incorporation.
11. The Design-Build Team shall provide safe access for wide-loads and oversized permitted vehicles through the work zone on all roadways within the project limits. Safe access shall entail, but is not limited to, a sufficient pavement structure and required vertical clearance and minimum clear widths as follows:

Roadway	Minimum Clear Width
I-85	20 feet
All other roadways	18 feet

12. In addition to the Incident Management Scope of Work requirements defined elsewhere in this RFP, the Design-Build Team shall utilize Changeable Message Signs (CMS) as follows :
- For traffic control purposes during construction, the Design-Build Team shall provide and operate a minimum of one CMS per direction on I-85 that provides general construction activity information about the construction activities within the project limits. These CMSs shall be in addition to any other CMSs required by the Roadway Standard Drawings.
 - In addition to the above requirements and expressly for the purpose of managing incidents on I-85 during construction, the Design-Build Team shall provide and operate a minimum of two additional (2) CMSs per direction to display alternate route information ahead of the detour points on I-85. The positioning of these incident management CMSs will be as directed by the Engineer. These CMSs shall be in addition to any other devices provided by the Department and operated by the Metrolina and/or Triad Traffic Management Centers (TMC). The Design-Build Team shall coordinate with the TMCs when alternate route information needs to be displayed.

- These CMSs shall have the ability to be controlled remotely by the TMCs and operated in the field by the Design-Build Team
 - Alternate routes, CMS locations and CMS messages shall be reviewed and approved by the Department prior to incorporation
 - The Design-Build Team shall show approximate CMS locations, along with the respective messages that have been coordinated with the TMCs, in the Traffic Control Plans.
13. The Design-Build Team shall provide a smooth pavement surface for traffic at all times. The Design-Build Team shall not place traffic on lanes containing rumble strips.
 14. The Design-Build team shall make all required modifications to existing pavement markings, markers, and signing located outside the project limits on all roads that are necessitated by their Traffic Control Plans.
 15. US 29/70 is currently used as an alternate route for I-85 during incidents. Therefore, the Design-Build Team shall maintain traffic on US 29-70 in one direction of crossing over the river at all times. The Design-Build Team shall be responsible for constructing crossovers and furnishing the necessary traffic control devices to reverse traffic safely on US 29-70 in the event of an incident on I-85. (Reference the Incident Management Scope of Work found elsewhere in this RFP.) In the event of an incident on I-85, the Design Build Team shall be prepared and remove as necessary any lane closure that is installed on US 29-70 as directed by the Engineer.

B. Traffic Control Plan requirements:

The Design-Build Team shall select a Private Engineering Firm (PEF) that has experience designing and sealing Traffic Control Plan for the North Carolina Department of Transportation (NCDOT) on comparable projects. The Design-Build Team shall list projects in the Technical Proposal, including description and similarity to the subject project that the PEF developed.

The Design-Build Team shall develop Traffic Control Plan that maintain all types of traffic (motorists, bicyclists, and pedestrians within the highway, including persons with disabilities in accordance with the Americans with Disabilities Act of 1990 (ADA), Title II, Paragraph 35.130) as defined by the *Manual for Uniform Traffic Control Devices (MUTCD)*.

The Traffic Control Plan shall adhere to the “Design-Build Submittal Guidelines” and the “Guidelines for Preparation of Traffic Control and Pavement Marking Plans for Design-Build Projects”, which by reference are incorporated herein and are a part of the contract. These documents are available on the Design-Build website.

The Work Zone Traffic Control web site contains useful information that may be needed for the design of the Traffic Control Plan.

<http://www.ncdot.org/doh/preconstruct/wztc>

II. Project Operations Requirements

The following are Time Restrictions and notes that shall be included with the Traffic Control Plans General Notes unless noted otherwise elsewhere in this RFP:

A. Time Restrictions

1. Intermediate Contract Time #1 for Lane Narrowing, Closure, Holiday and Special Event Restrictions.

As a minimum, the Design-Build Team shall maintain existing traffic patterns and shall not close or narrow a lane during the times below. When traffic is placed into the final pattern for any roadway, that will become the minimal traffic pattern and the following time restrictions shall still apply.

Road Name	Time Restrictions
I-85 and all ramps	Monday to Friday - 6:00 a.m. to 8:00 p.m. Saturday & Sunday - 11:00 a.m. to 8:00 p.m.

The Design-Build Team shall not install, reset, and / or remove any traffic control device during the times listed above.

In addition to the lane narrowing and closure restrictions stated above for all roads, during holidays, holiday weekends, special events, or any other time when traffic is unusually heavy on the roadways listed herein as directed by the Engineer, the Design-Build Team shall not close or narrow a lane of traffic, detain the traffic flow or alter the traffic flow on the aforementioned facilities. As a minimum, these requirements / restrictions apply to the following schedules:

- (a) For New Year's between the hours of 8:00 p.m. December 31st to 6:00 a.m. January 3rd. If New Year's Day is on a Friday, Saturday or a Sunday, then from 8:00 p.m. the day before New Year's Day to 6:00 a.m. the following Tuesday.
- (b) For Easter, between the hours of 8:00 p.m. the Friday before Easter and 6:00 a.m. the Tuesday after Easter.
- (c) For Memorial Day, between the hours of 8:00 p.m. the Friday before Memorial Day to 6:00 a.m. the Wednesday after Memorial Day.
- (d) For Independence Day, between the hours of 8:00 p.m. July 3rd and 6:00 a.m. July 6th. If Independence Day is on a Friday, Saturday or Sunday, between the hours of 8:00 p.m. the Thursday before Independence Day and 6:00 a.m. the Tuesday after Independence Day.
- (e) For Labor Day, between the hours of 8:00 p.m. the Friday before Labor Day to 6:00 a.m. the Wednesday after Labor Day.

- (f) For Thanksgiving, between the hours of 8:00 p.m. the Tuesday before Thanksgiving to 6:00 a.m. the Tuesday of the following week.
- (g) For Christmas, between the hours of 8:00 p.m. the Friday before the week of Christmas Day and 6:00 a.m. the following Tuesday after the week of Christmas Day.
- (h) For any NASCAR race at the Charlotte Motor Speedway, between the hours of 8:00 p.m. the Thursday of the week of the race until 6:00 a.m. the following Monday after the week of the race.
- (i) For any Carolina Panthers game in Charlotte, six (6) hours before the game and six (6) hours after the game.
- (j) For ACC Tournament between the hours of 8:00 p.m. the Tuesday of the week of the Tournament until 6:00 a.m. the following Monday after the Tournament.

Liquidated Damages for Intermediate Contract Time #1 for the above lane narrowing, lane closure, holiday and special event time restrictions for I-85 and all ramps is \$10,000.00 per hour or any portion thereof.

2. Intermediate Contract Time #2 for Road Closure Restrictions for Construction Operations.

As a minimum, the Design-Build Team shall maintain the existing traffic pattern for all roadways and follow the road closure restrictions listed below. When a road closure is used, the Design-Build Team shall reopen the travel lanes by the end of the road closure duration to allow the traffic queue to deplete before re-closing the roadway.

The Design-Build Team shall not close any direction of travel for the following roads during the times noted below. Closure of these roads or any ramps shall only be allowed for the operations listed in this intermediate contract time restriction. Using a median cross-over, exclusively for the operations listed below, shall be defined as a closure of a direction of travel.

Road Name	Time Restrictions
I-85 and all ramps	Sunday to Saturday - 6:00 a.m. to 12:00 a.m. (midnight)

Maximum road closure duration of **30 minutes** shall be allowed for the roadways listed in this ICT for the following operations:

- Traffic shifts to complete tie-in work and placement of pavement markings and markers

- Girder installation or removal of existing girders
- Installation of overhead sign assemblies and / or work on existing overhead sign assemblies over travel lanes

Proposed road closures for any road within the project limits shall be approved by the Engineer prior to incorporation in the Traffic Control Plans.

Liquidated Damages for Intermediate Contract Time #2 for the above road closure time restrictions for I-85 and all ramps are \$5,000.00 per 15-minute period or any portion thereof.

4. Hauling Restrictions

The Design-Build Team shall adhere to the hauling restrictions noted in the NCDOT 2006 *NCDOT Standard Specifications for Roads and Structures*.

The Design-Build Team shall conduct all hauling operations as follows:

- The Design-Build Team shall not haul against the flow of traffic of an open travelway unless an approved temporary traffic barrier or guardrail protects the work area.
- The Design-Build Team shall not haul during the holiday and special events time restrictions listed in Intermediate Contract Time #1.
- Haul vehicles shall not enter and / or exit an open travel lane at speeds more than 10 mph below the posted speed limit.
- Hauling access to the I-85 median will be allowed at the beginning and end of the project. Additional hauling access points to the I-85 median shall be limited to one per direction, at a location chosen by the Design-Build Team and approved by the Department.
- Single vehicle hauling and multi-vehicle hauling shall not be allowed ingress and egress from any open travel lane during the following time restrictions:

For Single Vehicle Hauling

Road Name	Day and Time Restrictions	
-L- (I-85) & ramps	6:00 a.m. to 9:00 a.m. and 3:00 p.m. to 8:00 p.m.	Monday – Friday

For Multi-Vehicle Hauling

Road Name	Day and Time Restrictions	
-L- (I-85) & ramps	6:00 a.m. to 8:00 p.m. 11:00 a.m. to 8:00 p.m.	Monday – Friday Saturday and Sunday

The Design-Build Team shall address how hauling will be conducted in the Technical Proposal, including but not limited to, hauling of materials to and from the site and hauling of materials within NCDOT right of way.

B. Lane and Shoulder Closure Requirements

The Design-Build Team shall not install more than three (3) miles of lane closures **in each direction of a multilane divided** roadway within the project limits or in conjunction with this project, measured from the beginning of the merge taper to the end of the lane closure.

On multilane facilities, the Design-Build Team shall not install more than one simultaneous lane closure, in any one direction.

The Design-Build Team shall remove lane closure devices from the lane when work is not being performed behind the lane closure or when a lane closure is no longer needed.

When personnel and / or equipment are working within 15 feet of an open travel lane, the Design-Build Team shall close the nearest open shoulder using NCDOT *2006 Roadway Standard Drawing* No. 1101.04, unless the work area is protected by an approved temporary traffic barrier or guardrail.

When personnel and / or equipment are working on the shoulder adjacent to an undivided facility and within 5 feet of an open travel lane, the Design-Build Team shall close the nearest open travel lane using NCDOT *2006 Roadway Standard Drawing* No. 1101.02, unless the work area is protected by an approved temporary traffic barrier or guardrail.

When personnel and / or equipment are working on the shoulder adjacent to a divided facility and within 10 feet of an open travel lane, the Design-Build Team shall close the nearest open travel lane using NCDOT *2006 Roadway Standard Drawing* No. 1101.02, unless the work area is protected by an approved temporary traffic barrier or guardrail.

When personnel and / or equipment are working within a lane of travel of an undivided or divided facility, the Design-Build Team shall close the lane using the appropriate roadway standard drawing from the NCDOT *2006 Roadway Standard Drawings*. The Design-Build Team shall conduct the work so that all personnel and / or equipment remain within the closed travel lane.

The Design-Build Team shall not perform work involving heavy equipment within 15 feet of the edge of travelway when work is being performed behind a lane closure on the opposite side of the travelway.

C. Pavement Edge Drop off Requirements

The Design-Build Team shall backfill at a 6:1 slope up to the edge and elevation of the existing pavement and / or use proper traffic control setup to protect traffic from the drop off as follows:

- Elevation differences that exceed 2 inches on roadways with posted speed limits of 45 mph or greater and a paved shoulder four-foot wide or less.
- Elevation differences greater than 3 inches on roadways with posted speed limits less than 45 mph and with a paved shoulder four-foot wide or less.
- Refer to the *2002 AASHTO Roadside Design Guide* for proper treatment of all other conditions.

Do not exceed a difference of 2 inches in elevation between open lanes of traffic for nominal lifts of 1.5 inches. Install advance warning “UNEVEN LANES” signs (W8-11) 1000 feet in advance and a minimum of every half mile throughout the uneven area.

D. Traffic Pattern Alterations

The Design-Build Team shall notify the Engineer in writing at least twenty-one (21) calendar days prior to any traffic pattern alteration. (Reference the Public Information Scope of Work for providing information to the public.)

E. Signing

The Design-Build Team shall install advance work zone warning signs when work is within 100 feet from the edge of travel lane and no more than three days prior to the beginning of construction.

When no work is being conducted for a period longer than one week, the Design-Build Team shall remove or cover all advance work zone warning signs, as directed by the Engineer. Stationary work zone warning signs shall be covered with an opaque material that prevents reading of the sign at night by a driver traveling in either direction.

When portable signs not in use for periods longer than 30 minutes, the Design-Build Team shall lay the portable work zone sign flat on the ground and collapse the sign stand and lay it flat on the ground.

The Design-Build Team shall be responsible for the installation and maintenance of all detour signing. The Design-Build Team shall cover or remove all detour signs within and off the project limits when a detour is not in operation.

The Design-Build Team shall ensure proper signing (including but not limited to guide signs) are in place at all times during construction, as required by the *MUTCD*.

F. Traffic Barrier

The Design-Build Team shall use only an NCDOT approved temporary traffic barrier system and adhere to the following requirements.

Install temporary traffic barrier system a maximum of two (2) weeks prior to beginning work in any location. Once the temporary traffic barrier system is installed at any location, proceed in a continuous manner to complete the proposed work in that location.

Once the temporary traffic barrier system is installed and no work has been or will be performed behind the temporary traffic barrier system for a period longer than two (2) months, remove / reset the temporary traffic barrier system unless the barrier is protecting a hazard.

Protect the approach end of temporary traffic barrier system at all times during the installation and removal of the barrier by either a truck mounted impact attenuator (maximum 72 hours) or a temporary crash cushion.

Protect the approach end of temporary traffic barrier system from oncoming traffic at all times by a temporary crash cushion unless the approach end of temporary traffic barrier system is offset from oncoming traffic as follows:

Posted speed limit (MPH)	Minimum offset (feet)
40 or less	15
45 - 50	20
55	25
60 mph or higher	30

Install temporary traffic barrier system with the traffic flow, beginning with the upstream side of traffic. Remove the temporary traffic barrier system against the traffic flow, beginning with the downstream side of traffic.

Install drums to close or keep closed tangent sections of the roadway until the temporary traffic barrier system can be placed or after the temporary barrier system has been removed. The distance, in feet, between drums shall be no greater than twice the posted speed limit (MPH).

At acceleration ramps / loops, install temporary traffic barrier system in a manner that provides a minimum of 200 feet from the end of the pavement marking taper to the beginning of the barrier taper.

The Design-Build Team shall be responsible for providing proper connection between the existing bridge rail and the temporary barrier system and include this information in the appropriate plans.

G. Traffic Control Devices

The Design-Build Team shall use traffic control devices that conform to all NCDOT requirements and are listed on the NCDOT's Approved Products List. The Approved Products List is shown on NCDOT's Work Zone Traffic Control website. The use of any devices that are not shown on the Approved Product List shall require written approval from the Transportation Management Director.

In tangent sections, channelizing device spacing shall not exceed a distance in feet equal to twice the posted speed limit. At intersections and driveway radii, channelization devices shall be spaced 10 feet on-center and 3 feet off the edge of an open travelway, when lane closures are not in effect. Skinny drums shall only be allowed as defined in Section 1180 of the 2006 *NCDOT Standard Specifications for Roads and Structures*.

Place Type III barricades, with "ROAD CLOSED" signs (R11-2) attached, of sufficient length to close entire roadway. Stagger or overlap barricades to allow for ingress or egress.

When a CMS is placed within the clear zone, provide proper delineation and protection for the traveling public.

Place sets of three drums perpendicular to the edge of the travelway on 500-foot centers when unopened lanes are closed to traffic. These drums shall be in addition to channelizing devices.

H. Temporary Pavement Markings, Markers and Delineation

The Design-Build Team shall provide a Temporary Pavement Marking Plans that meets the requirements of the RFP and the *Guidelines for Preparation of Traffic Control and Pavement Marking Plans for Design-Build Projects*.

The Design-Build Team shall use pavement marking and marker products that conform to all NCDOT requirements and are listed on the NCDOT's Approved Products List. The Approved Products List is shown on NCDOT's Work Zone Traffic Control website. The use of any devices that are not shown on the Approved Product List shall require approval from the Director of the Transportation Project Management Unit.

The Design-Build Team shall install pavement markings and markers in accordance with the NCDOT 2006 *Standard Specifications for Roads and Structures*, and in accordance with the manufacturer's procedures and specifications.

The Design-Build Team shall install temporary pavement markings that are the same width as existing on all roadways.

The Design-Build Team shall install temporary pavement markings and temporary pavement markers on the interim surface or temporary pattern as follows:

Road	Marking	Marker
All Roads and Existing Structures.	Minimum of Paint	Raised Temporary
Proposed Structures	Cold Applied Plastic (Type IV)	Raised Temporary

The Design-Build Team may use any type of pavement markings on the NCDOT Approved Products List for temporary pattern. However, the Design-Build Team shall maintain a minimum retroreflectivity for pavement marking on all roads (existing and temporary) at all times during construction, as follows:

White:	125 mcd / lux / m ²
Yellow:	100 mcd / lux / m ²

When using Cold Applied Plastic (Type IV) pavement markings, place temporary raised markers half on and half off edgelines and centerlines to help secure the tape to the roadway. Markers shall be spaced the appropriate distance apart as described by the 2006 *Roadway Standard Drawing* 1250.01, Sheet 1 of 3.

Prior to opening a roadway to traffic on facilities that the installation of a proposed monolithic island has not occurred, outline the location of the proposed monolithic island with the proper color pavement marking.

Tie proposed pavement marking lines to existing pavement marking lines.

Replace any pavement markings that have been damaged by the end of each day's operation.

The Design-Build Team shall not place temporary markings on any final asphalt pavement surface unless the temporary markings are placed in the exact location of the final pavement marking.

The Design-Build Team shall remove all conflicting markings or markers prior to shifting traffic to a new pattern.

Removal of the temporary pavement markings shall be accomplished by using water blasting, sand blasting, shot blasting systems or other NCDOT approved systems to minimize damage to the road surface. All systems shall be required to remove 100% of the pavement marking without removing more than 1/32 inch of the pavement surface.

I. Temporary Signals

Use the following notes if the Design-Build Team recommends using temporary signals for maintenance of traffic.

- Notify the Engineer two months before a traffic signal installation by others is required.
- Shift and revise all signal heads as shown on the approved Design Build signal plans.

J. Miscellaneous

Provide portable temporary lighting to conduct night work in accordance with the NCDOT 2006 *Standard Specifications for Roads and Structures*.

Provide proper drainage for all temporary alignment and or traffic shifts.

Law enforcement officers shall be used to help protect workers and road users, and to maintain safe and efficient travel through the work zones. The Design Build Team shall use law enforcement officers during installation, operation, and removal of lane closures on I-85. The Design-Build Team shall use a minimum of one law enforcement officer per each lane closed. The Design-Build Team shall be responsible for coordinating with the law enforcement agency for the use of law enforcement officers. The Design-Build Team shall address where and how law enforcement officers will be used in the Technical Proposal. The Design-Build Team shall only utilize officers who are outfitted with law enforcement uniforms and marked vehicles, which are equipped with proper lights mounted on top of the vehicle and agency emblems.

No Parking / Tow Away Zone signs shall be installed 1000 feet in advance of the *Begin Road Work* sign on all on-ramps within the project limits, and a minimum of every 3000 feet in each direction of I-85 within the I-85 widening project limits.

Coordinate with the NCDOT Resident Engineer in charge of any project in the vicinity of this project for any work that may affect the construction and the temporary traffic control of this project.

The Department will consider a \$250 speeding penalty ordinance on I-85 during construction. Guidelines for a \$250 speeding penalty ordinances are located on the Work Zone Traffic Control website. If the guidelines justify the need for the ordinance, an engineering study will need to be performed by an NCDOT Regional Traffic Engineer and the Ordinance signed by the NCDOT State Traffic Engineer. Submit request for the engineering study to be performed for the \$250 speeding penalty ordinance to the Director of the Transportation Project Management Unit and allow 6 weeks to complete the study and provide ordinance(s) if approved.

The Department will not grant approval for a speed limit reduction on I-85 during construction. The Design Build Team is encouraged to use innovative methods to enhance compliance by motorists to the current posted speed limit of 55 mph.

Temporary Shoring for the maintenance of traffic is defined as shoring necessary to provide lateral support to the side of an excavation or embankment parallel to an open travelway when a theoretical 2:1 (H:V) slope from the bottom of the excavation or embankment intersects the existing ground line closer than 5 feet from the edge of pavement of the open travelway. The Design-Build Team shall identify locations where temporary shoring for maintenance of traffic will be required on the Traffic Control Staging Concept. The Design-Build Team shall install temporary traffic barrier as shown on a detail available from the Work Zone Traffic Control **Section** that provides design information on the temporary traffic barrier location in relation to the temporary shoring and traffic location. The NCDOT Geotechnical Engineering Unit and Work Zone Traffic Control Section websites have more information on temporary shoring. (Notes related to Temporary Shoring are not required in the General Notes sheet for the Traffic Control Plan)

<http://www.ncdot.org/doh/preconstruct/highway/geotech/formdet/standards.html>

<http://www.ncdot.org/doh/preconstruct/wztc/DesRes/English/TemporaryShoring/TempShoring.pdf>

The Design-Build Team shall adhere to the additional shoring requirements located on the Work Zone Traffic Control **Section** and Geotechnical Engineering Unit websites.

The Design-Build Team shall identify on the appropriate traffic control detail where temporary shoring will be used by providing station limits, offsets, the type of shoring and where temporary traffic barrier will be located if needed.

K. Traffic Control Supervisor

The Design-Build Team shall furnish a Traffic Control Supervisor for the project who is knowledgeable of Traffic Control Plan design, devices and application, and has full authority to ensure traffic is maintained in accordance with the plans and specifications.

The Design-Build Team shall identify a Traffic Control Supervisor in their Technical Proposal that has the following qualifications:

- (A) A minimum 24 months of On-the-Job Training in supervision and work zone set up and implementation.
- (B) Be certified by responsible party (contractor or NCDOT) to have the required experience and training and is qualified to perform the duties of this position. If certified by the Contractor, a notarized certification letter shall be furnished to the Engineer at the preconstruction meeting. The letter shall state the Traffic Control

Supervisor is qualified, and state that the Traffic Control Supervisor has the authority to ensure traffic is maintained in accordance with the contract documents.

The Traffic Control Supervisor for the project shall be capable of performing the following:

- (1) Be available and on call at all times to direct / make any necessary changes in the traffic control operations in a timely and safe manner. The Design Build Team shall provide the Engineer with back up contacts for times when the Traffic Control Supervisor is not available at the project.
- (2) Coordinate and cooperate with traffic control supervisors of adjacent, and overlapping construction projects, as well as construction projects in proximity to the subject project, to ensure safe and adequate traffic control setup is maintained throughout the project at all times, including periods of construction inactivity.
- (3) Coordinate and cooperate with Rowan and Davidson County Maintenance Engineer in the event of a serious backup or incident on I-85.
- (4) Coordinate and cooperate with personnel at the Metrolina and Triad Traffic Management Centers to ensure proper messages are displayed on the CMSs and DMSs.
- (5) Provide traffic control setup that ensures safe traffic operations and workers' safety throughout the construction area.
- (6) Attend all scheduled incident management, traffic control coordination, and team meetings, as required by the Engineer.
- (7) Monitor traffic delays and backups within the work zone. Coordinate with the TMCs as required by this Scope of Work. (Reference Design Parameter #12.)

INCIDENT MANAGEMENT SCOPE OF WORK (12-21-09)

Traffic Control Devices for Incident Management

The Department shall use traffic control devices for the purposes of incident management during the construction of the project. The devices required by this scope of work are in addition to those required by the Traffic Management Scope of Work and the Traffic Control Plans developed by the Design-Build Team.

The Design-Build Team shall furnish, install at locations as directed by the Engineer, and maintain in good operating condition the traffic control devices noted herein (including stationary signing) for the duration of the project. These devices will be used by the Department for diverting traffic onto US 29 / 70 in the case of an incident blocking multiple lanes on I-85. The Department will execute all diversions. Upon completion of the project, all traffic control devices shall be left in place on the project as directed by the Engineer. Reference the Traffic Management Scope of Work.

The Design Build Team shall provide the following Traffic Control Devices unless otherwise directed by the Engineer:

- 1 - Flashing Arrow Panel
- 1 - Portable Changeable Message Sign
- 310 - Skinny Drums
- 15 - Drums
- 5 – 6' wide Type III Barricades

The Design-Build Team shall provide a Pace American trailer, model CS816TA2 or equivalent enclosed trailer to store the traffic control devices in the vicinity of the project at a secure location to be approved by the Engineer. The location of the trailer shall be accessible to the Department at all times in the event an incident occurs.

The Design-Build Team shall ensure that all traffic control devices and trailer are in good operational and mechanical condition during the construction of the project and are in accordance with the NCDOT *2006 Standard Specifications for Roads and Structures*.

When the project is completed, the Design-Build Team shall deliver the traffic control devices and trailer to the Department in good operational and mechanical condition including all manuals, maintenance records, special tools, hardware, parts, etc and in accordance with the NCDOT *2006 Standard Specifications for Roads and Structures*.

The Design-Build Team shall furnish and install the following stationary warning signs:

- 1 - 48" x 48" Lane Ends Merge Symbol (W4-2R)
- 1 - 48" x 48" Right Lane Closed (W20-5)
- 1 - 48" x 48" Transition Symbol (W1-4L)
- 1 - 48" x 48" Right Lane Closed Ahead (W20-5)

The Design-Build Team shall furnish a flip cover for each warning sign. The Department will provide the Design-Build Team the flip cover design. The location of these signs will be determined by the Department.

SIGNING SCOPE OF WORK (12-21-09)

General

The Signing Plans shall be prepared by the Design-Build Team in accordance with the latest edition of the *2003 Manual on Uniform Traffic Control Devices (MUTCD)*, the *2004 NC Supplement to the MUTCD*, *NCDOT Standard Specifications for Roads and Structures* (July 2006), the NCDOT Roadway Standard Drawings (July 2006) for the design and development of signing plans, the latest Standard Specifications for *Structural Supports for Highway Signs, Luminaires, and Traffic Signals* published by AASHTO, “*Guidelines for Preparation of Signing Plans for Design-Build Projects*”, and the “*Design-Build Submittal Guidelines*” and the contract requirements contained herein.

Signing Plan Requirement

The Design-Build Team shall select a Private Engineering Firm (PEF) that has experience in designing and sealing Signing Plans for NCDOT on projects comparable to this project. The Technical Proposal shall list projects, where Signing Plans were developed by the PEF, including description and similarity to the subject project.

Signs Furnished by Design-Build Team

The signs shall be furnished by the Design-Build Team according to the specifications provided by the NCDOT.

Signing Project Limits

The Design-Build Team shall be responsible for the design, fabrication and installation of all signs required through the construction limits of the mainline, all –Y- Lines and all cul-de-sacs. The Design-Build Team shall also be responsible for the design, fabrication and installation of all signs required beyond the construction limits of the mainline, all –Y- Lines and all cul-de-sacs to ensure adequate advance signage and spacing is provided.

The Design-Build Team shall be responsible for replacing and repositioning “EXIT ONLY” advance and exit directional signing for northbound I-85, Exits 79 and 81, to reflect the final traffic pattern. The Design-Build Team shall replace the “Spencer ¾ Mile” northbound I-85 ground mounted advance guide sign with an overhead sign assembly.

The posted speed limit for this facility shall be 65 mph.

Sign Design

The Design-Build Team shall be responsible for all Type A, B, and D sign designs, fabrication and installation for ground mounted signs. The Design-Build Team shall be responsible for sizing, fabricating, locating and installing all Type E (warning and regulatory signs), Type F signs (route

marker assemblies) and milemarkers. The milemarker designs shall be in accordance with the Intermediate Enhanced Reference Location Signs (D10-4) referenced in the *Standard Highway Signs* (2004 Edition).

The Design-Build Team shall design, fabricate and install Thru Bolts for Type “A” Signs in accordance with the NCDOT Roadway Standard Drawing No. 901.10 dated January 2008.

All sign designs shall be included in the Signing Plans. All sign designs shall be prepared using the latest version of GuideSign software. The latest GuideSign updates are located at the following website:

<http://www.ncdot.org/doh/preconstruct/traffic/congestion/SIGN/default.html>

Logo Signs

The Design-Build Team is not responsible for designing, locating, or installing any new Logo signs (blue service signs with specific business panels included on signs); however, the Design-Build Team shall be responsible for relocating existing Logo signs upon completion of the widening, realignment, or other construction procedures.

Sign Maintenance

The Design-Build Team shall maintain all existing signs during construction, including temporary installations of Guide and Logo Signs on supports to ensure signs are properly maintained and visible during project construction.

If damage occurs to the Logo Signs or the business panels during construction or installation, notify the Division Logo Coordinator as soon as possible. The Design-Build Team shall be responsible for replacement of Logo Signs or Logo business panels should damage occurs. If the Logo Signs are removed and disposed of per the RFC signing plans, the business panels on the signs shall be removed and returned to the Division Logo Coordinator. The order of preference for Logo Signs shall be maintained during project construction (see MUTCD section 2F.02).

Temporary Signs

The Design-Build Team shall be responsible for designing, fabricating, and installing temporary signs and supports. Reference the Signing Section of the Traffic Management Scope of Work found elsewhere in this RFP for additional temporary signing requirements.

Sign Locations

The Design-Build Team shall be responsible for determining the station locations for all signs. To avoid sign placement in locations where their usefulness will be short-lived, the Design-Build Team shall coordinate the proposed sign designs and locations with existing and future projects through the Department.

Ground Mounted Support Designs

NCDOT will provide the software for ground mounted sign support designs. The Design-Build Team is responsible for all design, fabrication, and installation of ground mounted supports and signs. Instructions for loading support design software will be made available upon request.

Overhead Sign Assemblies

The Design-Build Team shall design, fabricate and install overhead sign assemblies that meet all Department requirements. The windspeed for the overhead sign assembly designs shall be 90 mph. The Design-Build Team shall be responsible for calculating the windload area for the overhead sign assembly. The windload area shall be flush with the sign height and width. When calculating the windload area, the Design-Build Team shall include exit panels as part of the sign height. The coordination with future projects and sign messages shall be considered when designing and fabricating overhead sign assemblies.

The minimum vertical clearance beneath all overhead sign assemblies shall be 17 feet.

The Design-Build Team shall design, fabricate, and install overhead and pedestal sign supports and foundations in accordance with the Overhead Sign Supports and Overhead Sign Foundations Project Special Provisions found elsewhere in this RFP.

When applicable, the Design-Build Team has the option to mount signs vertically centered on the horizontal member of the overhead structure or to locate the bottom edge of all signs on each assembly in a horizontal plane.

Lighting will not be required on overhead sign assemblies.

Pedestal Overhead Sign Assemblies Option

For multi-lane facilities, the Design-Build Team has the option to design pedestal overhead sign assemblies or cantilever overhead sign assemblies for advance guide signs only. Pedestal overhead sign assemblies shall not be allowed for signs with "EXIT ONLY" designations. Exit directional signing shall be mounted on cantilever overhead sign assemblies over the appropriate lane(s). The Design-Build Team shall clearly indicate in their Technical Proposal their intention to provide pedestal overhead sign assemblies for advance guide signs.

All pedestal overhead sign assemblies shall have a 20-foot maximum offset from the edge of pavement to the centerline of the support. The Design-Build Team shall install guardrail or other approved positive protection barrier.

Overhead Sign Supports for Freeways

Overhead sign supports shall be located a minimum of 40 feet from the edge of the outside travel lane to the center of the sign support. If the minimum 40-foot distances cannot be obtained, the overhead sign supports shall be located a minimum of 20 feet from the outside travel lane and protected by guardrail or other NCDOT approved positive protection barrier.

The Design-Build Team shall provide the appropriate positive protection and drainage for all overhead sign median supports.

Overhead Sign Sheeting

The Design-Build Team shall design and fabricate overhead signs using Type VII, IX or XI retroreflective sheeting for the legends (text) and background. The Type of sheeting selected by the Design-Build Team shall be consistent throughout the project.

Guardrail or Other Protection for Signs and Overhead Assemblies

The Design-Build Team shall be responsible for determining, designing and installing any protection for proposed and existing sign supports.

Signing Roadway Standards, Typical Sheets and Specifications

Signing roadway standards and typical sheets to be used in summarizing quantities, standard specifications, and compiling Type E and F signs can be located at the following website:

<http://www.ncdot.org/doh/preconstruct/traffic/congestion/SIGN/default.html>

The Design-Build Team shall incorporate the appropriate information onto these sheets and submit them to the Transportation Program Management Director for review and acceptance.

Removal and Disposal of Existing Signs

The Design-Build Team shall be responsible for determining those existing signs that will no longer be needed upon completion of the project, such as on -Y- lines and project tie-ins. The Design-Build Team shall be responsible for removal and disposal of these signs and supports. The Design-Build Team shall show and note these signs on the signing plan view sheets.

Construction Revisions

After submittal of RFC Signing Plans, all construction revision shall be submitted to the Department for review and acceptance prior to incorporation.

General

The Design-Build Team shall prepare Final Pavement Marking Plans in accordance with the latest edition of the *Manual on Uniform Traffic Control Devices (MUTCD)*, the NCDOT Roadway Standard Drawings (July 2006), “*Guidelines for Preparation of Traffic Control and Pavement Marking Plans for Design-Build Projects*”, and the “*Design-Build Submittal Guidelines*” and the contract requirements contained herein.

Final Pavement Marking Plan Requirements

The Design-Build Team shall select a Private Engineering Firm (PEF) that has experience designing and sealing Pavement Marking Plans for NCDOT on comparable projects. The Design-Build Team shall list projects, where Pavement Marking Plans were developed by the PEF, in the Technical Proposal, including description and similarity to the subject project.

The Design-Build Team shall develop Pavement Marking Plans that maintain all types of traffic (motorists, bicyclists, and pedestrians within the highway, including persons with disabilities in accordance with the Americans with Disabilities Act of 1990 (ADA), Title II, Paragraph 35.130) as defined by the *Manual for Uniform Traffic Control Devices (MUTCD)*.

Final Pavement Marking Project Limits

The Design-Build Team shall modify existing pavement markings, markers and signing located outside the project limits to ensure that all four lanes in each direction are open to through traffic, including the area from the previous project, I-2511CB, to this project.

The Design-Build Team shall use permanent markings and markers to designate the tapering of the eight-lane section down to the existing four-lane section.

The Final Pavement Marking Plans shall address any required modifications to existing pavement markings located outside the project limits to ensure appropriate tie-ins. The Design-Build Team shall be responsible for installing all pavement markings and markers located within and outside the project limits, resulting from the project construction.

Pavement Markings, Markers and Delineation

The Design-Build Team shall not place any final pavement markings and markers until the Final Pavement Marking Plans are submitted for review and acceptance.

The Design-Build Team shall use pavement marking, marker and other delineation products that conform to all NCDOT requirements and are listed on the NCDOT’s Approved Products List. The Design-Build Team shall contact the NCDOT Signing and Delineation Unit for a list of approved products and material.

The use of any devices that are not shown on the Approved Product List shall require written approval from the Transportation Program Management Director.

The Design-Build Team shall install pavement markings and markers in accordance with the NCDOT 2006 *Standard Specifications for Roads and Structures*, and in accordance with the manufacturer's procedures and specifications.

The Design-Build Team shall install pavement markings and pavement markers on the final surface as follows:

Road	Marking	Marker
-L- Line and Ramps, Including Bridge Decks	6 in Polyurea with Highly Retroreflective Elements	Snowplowable
-Y- Lines and Service Roads and Ramps	Thermoplastic	Permanent Raised
-Y- Lines Concrete Surfaces	Polyurea with standard beads or Cold Applied Plastic (Type II)	Permanent Raised

All Full Control of Access interstate facilities and US routes require 6 in wide pavement markings, i.e., lane lines, edge lines and skips for the final pavement marking.

Remove/Replace any conflicting/damaged pavement markings by the end of each day's operation.

Passing Zone(s) will be determined in the field and must be approved by the Engineer.

All stop bars at non-signalized intersections are to be located by the Design-Build Team.

Unless noted otherwise elsewhere in this RFP, removal of the temporary pavement markings shall be accomplished by using water blasting, grinding or other NCDOT approved systems to minimize damage to the road surface. Pavement markings on the final pavement surface of asphalt shall not be removed with water blasting.

RAILROAD COORDINATION SCOPE OF WORK (12-21-09)

The Department has secured all railroad agreements necessary for the construction of bridges over the Duke Power Industrial Spur and the North Carolina Railroad Company (“NCR”) operated by Norfolk Southern Railway (“NSR”) and the construction of new track along the NCR. The Design-Build Team shall be fully responsible for coordinating with the railroads any modification to these agreements that may be necessary based on their design or construction methods. Included in this scope of work is guidance to the Design-Build Team in the event an agreement modification is needed due to the Design-Build Team’s design or construction methods. The Design-Build Team shall be responsible for ascertaining NCDOT, NCR and NSR executed all applicable agreements necessary to institute the work of constructing the new track alignment (Track Improvement Work).

The NCR will make a capital investment in the project to improve track capacity and clearances in the project (“Track Improvement Work”). NSR shall procure all rail ties and other track materials at NCDOT’s cost (using the NCR Capital Investment.) NSR shall perform the new track work, including all materials for this work on a force account basis at NCDOT’s cost (using the NCR Capital Investment.) NSR shall determine final acceptance of Track Improvement work in collaboration with NCDOT Rail Division and NCR.

The Design-Build Team shall be responsible for final design of the trackwork as well as **grading, drainage and placement** of the sub-ballast within the limits of the Rail Preliminary Engineering (25%) drawing, dated **December 21, 2009** provided by the Department. NSR shall determine final acceptance of railroad roadbed construction including placement of subballast in collaboration with the Department’s Rail Division and NCR. All existing stone box culverts within the Track Improvement Work limits shall be grouted closed and replaced with new drainage structures of proper size and dimension to be installed via the Jack and Bore method. The Design-Build Team shall be responsible for integrating the Rail Preliminary Engineering (25%) Drawing, **dated December 21, 2009** drawing into final plans. The final plans shall meet the entire design criterion established in the Rail Preliminary Engineering (25%) drawing, dated **December 21, 2009**. The final track geometry shall not differ from the horizontal and vertical alignments in the Rail Preliminary Engineering (25%) drawing, dated **December 21, 2009**. The Design-Build Team shall provide Environmental Permitting for the **Track Improvement Work**, as necessary. The Design-Build Team shall submit the final plans via the Transportation Program Management Director to NCDOT Rail Division, NSR, and NCR for review and approval. The Design-Build Team shall coordinate construction details for the Track Improvement Work on **railroad right of way**. Coordination shall include any necessary agreements required by the NCDOT, NCR, or NSR. The Design-Build Team shall furnish As-built drawings for the new track alignment to NCDOT, NSR and NCR. The Design-Build Team shall be responsible for all costs incurred by NSR and NCR associated with the work performed by the Design-Build Team. Costs associated with this project shall include, but not be limited to, crossing surfaces, overhead crossings and the parallel roadway, bridge work, insurance, and flagging. The Design-Build Team shall not be responsible for the costs of work or materials associated with the track and signal portions of the Track Improvement Work to be constructed by NSR upon completion of the Design-Build Contract.

The Design-Build Team shall coordinate the Track Improvement Work with the following:

Brad Kerchof
Director of Engineering
Norfolk Southern Corporation
1200 Peachtree Street, NE
Atlanta, GA 30309-3579

Preparation for Construction within the Existing NCR Corridor, operated by NSR

- I. The Design-Build Team, unless otherwise provided or directed by NSR's Railroad Engineer via the NCDOT's Transportation Program Management Director, shall comply with the following applicable documents:
 - A. *AREMA Manual for Railroad Engineering, latest edition*
 - B. *Norfolk Southern Corporation Special Provisions for Protection of Railway Interest*
 - C. *Norfolk Southern's "Standard Specifications for Materials and Construction, August 1997."*
 - D. *Norfolk Southern Guidelines for Design of Grade Separation Structures*
 - E. *NCDOT's Rail Preliminary Engineering (25%) Drawing, dated December 21, 2009*
 - F. *Federal Aid Policy Guide 23 CFR 140I*
 - G. *Federal Aid Policy Guide 23 CFR 646*
 - H. *NCDOT Construction Manual Section 105-8*
 - I. *NCDOT Standard Specifications for Roads and Structures Section 107-9 (Excluding Paragraph 2)*
 - J. *North Carolina Administrative Code Section T19A: 02B, 0150 through 0158*
 - K. *North Carolina Railroad Company Form NCDR 103 Specific Requirements of North Carolina Railroad Company for Work on its Right of Way*
- II. The Design-Build Team shall be responsible for verifying the number of trains per day and maximum speed allowed.
- III. Railroad overhead bridge designs shall meet Norfolk Southern Corporation "*Guidelines for the Design of Grade Separation Structures,*" AREMA, and Norfolk Southern special provisions and all provisions required by the agreements, and shall meet the requirements of the respective underlying property owners Duke Power Company or NCR. Only NSR may grant exceptions to their guidelines or AREMA.
- IV. The railroad corridor is located on the NCR near Milepost 327.76 which NSR operates subject to a Trackage Rights Agreement with NCR. The corridor contains two tracks and serves both freight and conventional intercity passenger trains, and is a component of the federally designated Southeast High-Speed Rail Corridor. NCDOT, to allow constructing the structures, will relocate a portion of two rail tracks on the NCR corridor.

Arrangements for Protection and Adjustments to Existing and Proposed Railroad Crossing Surface and Roadbeds:

- I. The Design-Build Team shall make the necessary arrangements with NSR and NCRR for the installation of permanent and temporary grade crossing surfaces, removal of temporary construction crossings after completion of project, shoring plans, encroachment agreements, and railroad force account estimates and agreements. All permanent crossing surfaces shall be concrete, both field and gage. All crossing surfaces shall be procured and installed at the Design-Build Team's expense.

The Design-Build Team shall not commence any work on the NCRR or Duke Power right of way until all agreements have been executed, insurance acquired and approved, and all construction plans have been approved by the NSR.

The Design-Build Team shall make the necessary arrangements with the NSR that are required to protect against property damage that may result in loss of service, expense, or loss of life. The Design-Build Team shall be responsible for all damage to the NSR, NCRR and Duke Power resulting from their operations and the NSR may issue a stop order until all dangerous situations are remedied.

The Design-Build Team shall be responsible for providing Railroad Protective Liability Insurance for Bodily Injury Liability, Property Damage Liability, and Physical Damage to Property. The Track Improvement Work involves track over which passenger trains operate, Railroad Protective Liability Insurance limits required are not less than a combined single limit of \$5,000,000 each occurrence and \$10,000,000 in the aggregate applying separately to each annual period. Said policy shall provide coverage for all loss, damage or expense arising from bodily injury and property damage liability, and physical damage to property attributed to acts or omissions at the job site. For the work on the Duke Power Spur, Railroad Protective Liability Insurance limits required are not less than a combined single limit of \$5,000,000 each occurrence and \$6,000,000 in the aggregate applying separately to each annual period. Said policy shall provide coverage for all loss, damage or expense arising from bodily injury and property damage liability, and physical damage to property attributed to acts or omissions at the job site. The Design-Build Team shall be responsible for verifying and obtaining the appropriate insurance and coverage with the NSR and NCRR. Other insurance requirements, including those for all subcontractors, are detailed in the documents referenced herein.

- II. After negotiations between the Design-Build Team and the NSR and NCRR have been finalized, the Design-Build Team shall submit executed agreements and plans to NCDOT's State Bridge Design Engineer, via the Transportation Program Management Director, for plan approval and final agreement execution by NCDOT, prior to authorizing railroad work. After approval by NCDOT, one copy of the executed agreement will be returned to the Design-Build Team and one copy forwarded to the NCDOT's Resident Engineer, prior to any construction work by the Design-Build Team or NSR. This section particularly applies if a modification to an agreement is necessary.

Coordination of Overhead Bridge Work with Norfolk Southern Corporation:

The Design-Build Team shall coordinate with J. N. Carter, Jr., Chief Engineer, Bridges and Structures, Norfolk Southern Corporation, 1200 Peachtree St., NE Atlanta, GA 30309, (contact is Scott Overbey at telephone number 404-582-5588) to obtain plan approval and a partially executed legal agreement (as necessitated by a modification to the existing agreements) with NSR, NCR, and the Department of Transportation as the parties in the agreement for the Norfolk Southern Corporation the overhead grade separation.

The preliminary plan submittal to the NSR shall include bridge plans, the NSR's "Overhead Grade Separation Data Sheet," as applicable, appropriate roadway plan sheets showing impacts to the NCR's right of way, erosion control plans, and drainage calculations for any drainage on or across the NCR's right of way. A minimum of five (5) half-size sets of preliminary plans and data shall be submitted to NSR through the Transportation Program Management Director. If NSR requires RFC's and / or Final Plans, then five (5) half-size sets shall be submitted to the Transportation Program Management Director for forwarding to the NSR. If any re-submittals of plans or any additional information is required, five (5) half-size sets shall be submitted to the Transportation Program Management Director for forwarding to the NSR. Working Drawings affecting the NSR's operations and / or right of way shall follow the submittal process as outlined in the 2006 *Standard Specifications for Roads and Structures* or Special Provisions.

The Department will review all agreement modifications prior to submittal to the NSR. The Department will execute and distribute the Agreement modifications within 14 calendar days of receipt. The agreements and any modifications thereto shall include necessary Force Account items such as preliminary engineering, construction engineering, and flagging. The Department will be responsible for payment of the NSR's Force Account work; however, the Design-Build Team shall reimburse the Department for these costs including any Force Account estimate overruns. This reimbursement shall be incidental to the lump sum price bid for the project. Upon request, the Department will provide copies of the NSR's invoices to the Design-Build Team for review. The Design-Build Team shall have ten (10) days to provide written comments to the Transportation Program Management Director, after which the Department will pay the invoice. The Design-Build Team shall be responsible for maintaining records to verify the invoice items.

Site Specific Data for I-85 over Duke Power Industrial Spur

Freight track Railroad Protective Liability Insurance to be provided by the Design-Build Team for Bodily Injury Liability, Property Damage Liability, and Physical Damage to Property is typically \$2,000,000 Per Occurrence and \$6,000,000 Aggregate Per Annual Policy Period. Norfolk Southern Corporation may require additional insurance or coverage.

Per Duke Power there are an average of 11 freight trains per month through this bridge site at a maximum speed of 15 miles per hour.

Coordination with Duke Power Company

The Design-Build Team shall coordinate with Randy Herrin, Production Manager, Duke Power Company, 1555 Dukeville Road, Salisbury, NC 28146, telephone number 704-645-2731, to obtain plan approval and execution of the legal agreements (as necessitated by a modification to the existing agreements) by Duke Power for overhead bridges crossing Duke Power Industrial Spur.

The preliminary plan submittal to Duke Power Company (DPC) shall include bridge plans, NSC's "Overhead Grade Separation Data Sheet," appropriate roadway plan sheets showing impacts to DPC Right of Way, erosion control plans, and drainage calculations for any drainage on or across DPC Right of Way. A minimum of three (3) half size sets of preliminary plans and data shall be submitted to DPC. If DPC requires RFC's and /or final plans, then three (3) half size sets shall be provided to DPC. If any re-submittals of plans or any additional information is required, three (3) half size sets shall be submitted to DPC.

Coordination with North Carolina Railroad Company

The Design-Build Team shall coordinate with Justin Madigan, Property Manager, North Carolina Railroad Company, 2809 Highwoods Boulevard, Suite 100, Raleigh, NC 27604, telephone number 919-954-7601, to obtain plan approval and execution of the legal agreements (as necessitated by a modification to the existing agreements) by North Carolina Railroad Company for overhead grade separation bridges crossing the North Carolina Railroad Corridor.

The preliminary plan submittal to North Carolina Railroad (NCR) shall include bridge plans, NSC's "Overhead Grade Separation Data Sheet," appropriate roadway plan sheets showing impacts to the NCR Right of Way, erosion control plans, and drainage calculations for any drainage on or across NCR Right of Way. A minimum of three (3) half size sets of preliminary plans and data shall be submitted to NCR. If NCR requires RFC's and / or final plans, then three (3) half size sets shall be provided to NCR. If any re-submittals of plans or any additional information is required, three (3) half size sets shall be submitted to NCR.

The Design-Build Team shall coordinate the Track Improvement Work with the following:

Glenn Hartsoe
Consulting Engineer
North Carolina Railroad Company
809 Highwoods Boulevard, Suite 100
Raleigh, NC 27604-1000

Site Specific Data for I-85 over Yadkin River, surrounding wetlands, and North Carolina Railroad

Freight track Railroad Protective Liability Insurance to be provided by the Design-Build Team for Bodily Injury Liability, Property Damage Liability, and Physical Damage to Property is typically \$5,000,000 Per Occurrence and \$10,000,000 Aggregate Per Annual Policy Period. Norfolk Southern Corporation may require additional insurance or coverage.

Per Norfolk Southern Corporation there are an average of 24 freight trains a day through this bridge site at a maximum speed of 45 miles per hour an average of 6 passenger trains a day through this site at a maximum speed of 45 miles per hour. The proposed design speeds for the new alignment are 50 mph for freight trains, 60 mph for rail-highway trains, and 65 mph for intercity passenger trains.

UTILITIES COORDINATION SCOPE OF WORK (12-21-09)

Background and Status

The Department has initiated the agreements and coordination of utility relocation plans and the physical relocation of utilities on the project. The Department will provide a Utility Coordination Transfer Report which identifies all known utilities in conflict with the project as well as the approximate location of each utility, prior rights information, current status of the agreement or relocation, and estimated date of clearing of the conflict.

The Department will continue this coordination effort until the contract for this project is executed, at which time the Design-Build Team shall take over the relocation responsibilities as outlined in this scope of work for all utilities, including utility installation for lighting or any utilities in conflict with Track Improvement Work.

The Design-Build Team shall obtain the services of a Private Engineering Firm (PEF) knowledgeable in the NCDOT Utility Coordination Process involved with utility relocation / installation and highway construction. The Design-Build Team shall be responsible for coordinating all utility relocations, removals, and / or adjustments where the Design-Build Team and Utility Company, with concurrence from the Department, determine that such work is essential for highway safety and performance of the required highway construction. Coordination shall be for all utilities whether or not they are specifically identified in this scope of work and shall include any necessary utility agreements when applicable. NCDOT will be the approving authority for all utility agreements and approval of plans.

Cost Responsibility

The Design-Build Team shall be responsible for all costs associated with relocating water and sewer facilities. The Design-Build Team shall also be responsible for all costs associated with relocating or adjusting any utilities that have already been relocated once to accommodate the design shown on the Right of Way Plans provided by the Department.

Unless otherwise noted above, The NCDOT will be responsible for all other non-betterment utility relocation cost when the utility company has prior rights of way / compensable interest. The utility company shall be responsible for the relocation costs if they can not furnish evidence of prior rights of way or a compensable interest in their facilities. The Design-Build Team shall be responsible for determining the cost responsibility for the utility relocations. The Design-Build Team shall be responsible for all costs associated with utility relocations due to haul roads and / or any other temporary conditions resulting from the Design-Build Team's methods of operation or sequence of work. NCDOT will be the approving authority for all utility agreements and approval of plans.

Project Details

The Design-Build Team shall be responsible for verifying the utility locations, type of facilities, and identifying the utility owners in order to coordinate the relocation of any utilities, known and

unknown, in conflict with the project. The following utilities are known to be located within the project construction limits:

Utility Owner	Utility Type	Cost Responsibility
Duke Energy (Trans.) ¹	Power	NCDOT (Prior Rights)
Duke Energy (Dist.)	Power	NCDOT (Prior Rights)
AT&T ²	Telephone	Utility Owner
LexCom ³ Communications	Telephone (Buried)	Utility Owner
LexCom ⁴ Communications	Telephone (Aerial)	NCDOT (Prior Rights)
MCI	Telephone	Utility Owner
Piedmont Natural Gas	Natural Gas	NCDOT (Prior Rights)
Time Warner Cable	CATV	Utility Owner
Davidson County Water	Water and Sewer	NCDOT (G. S. 136-27)

¹ Duke Energy Transmission towers on plansheet 14 will NOT be relocated; a barrier will need to be placed from Stations 955+50 to 956+50 to protect the towers.

² AT&T buried line from Stations 825+00 to 837+00 will be replaced with an aerial line attached to Duke Energy Distribution poles, the buried line will be abandoned thereafter.

³ Lexcom will need to retain and maintain the buried cable feed on the L-line, rightside from plansheet 14 (Station 933+00) to plansheet 16 (Station 980+00) and on the Y-5 line, leftside from plansheet 23 (Station 11+00) to plansheet 24 (Station 64+50) until the aerial line on Y-1 has been put into place and is operational.

⁴ For Lexcom's aerial relocation, rough grading will be needed on the Y-1 line from Stations 22+00 to 50+00 on the left hand side.

Water and Sewer

If the Design-Build Team's design and / or construction requires the relocation of existing water or sewer facilities, designs shall be coordinated with the NCDOT Utility Coordination Unit. All costs associated with the design and construction for relocation of these existing water and / or sewer facilities shall be the responsibility of the Design-Build Team and shall be included in the lump sum bid for the project. The Design-Build Team shall develop designs; prepare all plans for needed agreements and permits; submit permits directly to the agencies and obtain approval from the agencies. The Design-Build Team shall be responsible for all permit fees.

Designs shall be coordinated with the NCDOT Utility Coordination Unit. The Design-Build Team shall be responsible for submitting five (5) sets of 11 x 17 utility construction drawings to the State Utility Agent, via the Transportation Program Management Director, for further handling. Each set shall include a title sheet, plan sheets, profiles and special provisions if required. Once approved by the State Utility Agent, the plans, with the appropriate agreement, will be sent out to Davidson County Water for their review and concurrence.

Utility Relocation Plans

In the event of a utility conflict, the Design-Build Team shall request that the utility company submit relocation plans (Highway Construction Plans to be provided by the Design-Build Team to Utility Owners) that show existing utilities and proposed utility relocations for approval by the NCDOT.

The Design-Build Team shall submit (3) three copies of the Utility Relocation Plans to the NCDOT State Utility Agent, via the Transportation Program Management Director, for review and approval prior to relocation work beginning. The Design-Build Team shall also be responsible for submitting the appropriate agreements to be used with the Utility Relocation Plans (See Agreements found elsewhere in this scope of work). After the review process is complete, the NCDOT Utility Coordination Unit will submit one (1) copy of the Utility Relocation Plans, executed agreements and any necessary comments back to the Design-Build Team. The NCDOT Utility Coordination Unit will also submit a copy of the approved Utility Relocation Plans to the Department's Resident Engineer. If the Utility Relocation Plans are approved subject to changes, it shall be the Design-Build Team's responsibility to coordinate these changes with the appropriate utility company.

Compensable Interest

Typically, affidavits, recorded easements or NCDOT agreements can serve as evidence of prior rights. A compensable interest is identified as follows:

- (A) Existing or prior easement rights within the limits of the project, either by recorded right of way or adverse possession (Utility occupying the same location for twenty (20) plus years outside the existing highway rights of way).
- (B) Entities covered under *General Statute 136-27.1* and *136-27.2*. Statute requires the NCDOT to pay the non-betterment cost for certain water, sewer and gas relocations.
- (C) Utilities that have a joint-use agreement that constitutes a compensable interest with entities that have existing or prior easements rights within the project limits.

Work Performed by Design-Build Team for Utility Owners

If the Design-Build Team elects to make arrangements with a Governmental Agency or any other utility owner for proposed utility construction, in which the Agency / Utility Owner shall be responsible for the costs of work to be performed by the Design-Build Team, the Design-Build Team shall be responsible for negotiating all costs associated with the proposed construction. Once the Design-Build Team and the Agency / Utility Owner agree on a plan and a lump sum estimated cost for the utility construction, the Design-Build Team shall be responsible for submitting five (5) sets of 11 x 17 utility construction drawings to the State Utility Agent, via the Transportation Program Management Director, for further handling. Each

set shall include a title sheet, plan sheets, profiles and special provisions if required. Also, a letter from the Agency / Utility Owner agreeing to the plans and lump sum cost must accompany this package. The NCDOT will reimburse the Design-Build Team the estimated lump sum cost under a Supplemental Agreement. The necessary Utility Agreement to the Agency / Utility Owner for reimbursement shall be a two party agreement between the NCDOT and the Agency / Utility Owner; and will be developed and executed by the Department.

If the Design-Build Team is requested, in writing, by a utility company to relocate facilities not impacted by the project's construction, and / or upgrade or incorporate new facilities as part of the highway construction, designs shall be coordinated with the Utility Owner and NCDOT Utility Coordination Unit. The associated design and construction costs shall be negotiated and agreed upon between the Design-Build Team and the utility company. The Design-Build Team shall develop designs; prepare all plans for needed agreements and permits; submit permits directly to the agencies and obtain approval from the agencies. The Design-Build Team shall be responsible for all permit fees.

Cable TV

The cost in relocating CATV due to the highway construction shall be the responsibility of the CATV Company; however, under the following conditions the Design-Build Team shall bear the relocation expense:

- (A) If the CATV Company can validate a recorded easement for facilities outside the maintained NCDOT rights of way.
- (B) The adjustment is needed on existing utility poles to accommodate a proposed NCDOT Traffic Management System Fiber Optic Communication Cable Project.

The NCDOT will not permit CATV to place poles within the highway rights of way but will allow down guys for their facilities within the highway rights of way. Under most circumstances, the CATV Company will continue a joint-use attachment with the local Power and Telephone Company. If the CATV proposed relocation places buried facilities within the highway rights of way then plans and encroachment agreements shall be required by the NCDOT.

Preparation for Communication Cables / Electrical Services for Lighting Devices:

Prior to establishing the location for new meter poles / boxes, the Design-Build Team shall coordinate with the local Power Distribution Company concerning accessibility of E/C Service and safety in maintenance of the meter.

Prior to installation, the Design-Build Team shall provide plans for review and approval for all service taps that require a parallel installation within the C/A.

Parallel service installation within a C/A shall be buried and located as close to the R/W line as practical. Only due to unusual circumstances will parallel aerial service installations within C/A

be allowed. The Design-Build Team shall justify the allowance of parallel aerial service installation and obtain NCDOT approval prior to installation

The Design-Build Team shall be responsible for all coordination activities required for the utility company to provide service taps. Prior to the Design-Build Team developing the associated design and / or instructing the utility company to proceed with providing the service taps, the Design-Build Team shall obtain written approval of the service tap locations from the Resident Engineer. The Department will be responsible for construction costs associated with the utility company providing service taps.

General

The Design-Build Team shall not commence work at points where the highway construction operations are adjacent to utility facilities, until making arrangements with the utility company to protect against damage that might result in expense, loss, disruption of service or other undue inconvenience to the public or utility owner. The Design-Build Team shall be responsible for damage to the existing or relocated utilities resulting from the Team's operations. In the event of interruption of any utilities by the project construction, the Design-Build Team shall promptly notify the proper authority (Utility Company) and cooperate with the authority in the prompt restoration of service.

The Design-Build Team shall accommodate utility adjustments, reconstruction, new installation and routine maintenance work that may be underway or take place during the progress of the contract.

If total property acquisition is unavoidable due to encroachment into wells and / or septic systems, then the Design-Build Team shall investigate and determine if extending water and / or sewer lines to the affected property is cost effective. If the Department concurs with the determination that a utility extension is cost effective, the costs associated with the utility construction shall be addressed in accordance with Article 104-7 of the Standard Specifications.

The Design-Build Team shall be required to use the guidelines as set forth in the following:

- (A) *NCDOT Utility Manual - Policies & Procedures for Accommodating Utilities on Highway Rights of Way*
- (B) *Federal Aid Policy Guide - Subchapter G, Part 645, Subparts A & B*
- (C) *Federal Highway Administration's Program Guide, Utility Adjustments & Accommodations on Federal Aid Highway Projects*
- (D) *NCDOT Construction Manual Section 105-8*
- (E) *NCDOT Right of Way Manual - Chapter 16 Utility Relocations*
- (F) *NCDENR Public Water Supply - Rules governing public water supply*
- (G) *NCDENR Division of Water Quality - Title 15A - Environment and Natural Resources*

Requirements For Attachments To Existing And/Or Proposed Structures:

The Design-Build Team shall avoid attachments to structures where feasible. Attachments shall only be considered when other alternatives are cost prohibitive and / or not feasible due to environmental or geographical features. Attachments shall be prohibited under the following conditions:

(A) Unless noted otherwise elsewhere in this RFP, no attachments will be allowed to a bridge located parallel within the C/A carrying the freeway over streams, other roadways or railroads. (No parallel utility installations within the C/A)

(B) Unless noted otherwise elsewhere in this RFP, no attachments will be allowed to cored-slab bridges.

(C) Unless noted otherwise elsewhere in this RFP, no attachments will be allowed to curved bridges.

Attachments to structures, if allowed, shall meet the following criteria.

(A) No attachments shall be allowed below the bottom of the beams and/or girders.

(B) Drilling of or attachments to beams and/or girders shall not be allowed. Attachments shall only be allowed to the bottom of the bridge deck.

(C) For water and sewer force mains, only restrained joint ductile iron pipe will be allowed.

(D) A minimum of 18" of clearance to beams and/or girders shall be maintained if possible.

Documentation of adverse conditions or cost estimates of all feasible alternatives should be submitted to the NCDOT State Utility Agent, via the Director of the Transportation Management Unit, when seeking approval of a structure attachment. Cost estimates shall consider all costs involved with each alternative and impacts to the utility and the highway project as a whole.

Agreements

If a utility company can provide evidence of prior rights of way or a compensable interest in their facilities, the Design-Build Team shall coordinate the non-betterment utility relocation cost with the utility company and develop the Utility Agreement. The Design-Build Team shall be required to utilize the NCDOT Three-Party Utility Relocation Agreement as required to relocate utilities.

The NCDOT State Utility Agent must execute approved agreements on Design-Build highway projects. The Utility Relocation Agreements (Cost Agreement) and encroachment agreements are available from the NCDOT Utility Coordination Unit. Reference Pages 59 and 60 of the *NCDOT Utility Manual on Policies & Procedures for Accommodating Utilities on Highway Rights of Way* for the different types of encroachment agreements available for use.

The Design-Build Team shall be required to utilize the NCDOT Standard Utility Encroachment Agreements as necessary in relocating utilities. The Encroachment Agreements shall be used under the following conditions:

- (A) If a utility company is not occupying a valid right of way / compensable interest and the proposed relocation will place the relocated utilities within the existing or proposed highway rights of way.
- (B) For **all** new utility installations within the existing or proposed highway rights of way. This includes all water, sewer and gas lines owned by entities covered under *General Statute 136-27.1* and *136-27.2*.
- (C) In either case above, the Design-Build Team shall submit 5 copies of the encroachment plans plus 2 originals and 3 copies of the encroachment agreement to the NCDOT State Utility Agent, via the Transportation Program Management Director, for approval.

RIGHT OF WAY SCOPE OF WORK (12-21-09)

The Department has acquired all right of way, easements and control of access for the project as shown on the Right of Way Plans provided by the Department. In the event that additional right of way, easements and / or control of access are needed to construct the project beyond that which has already been acquired by the Department, the Design-Build Team shall acquire the additional right of way, easement and / or control of access in accordance with the provisions of this scope of work.

The cost of the right of way, easement and control of access, as shown on the Right of Way Plans developed by the Department, has been borne by the Department. The cost of any additional right of way, easements and / or control of access as required by the Design-Build Team's design or construction methods, beyond that shown on the Right of Way Plans developed by the Department, shall be the responsibility of the Design-Build Team. There are two exceptions to this paragraph:

If the Design-Build Team demonstrates to the Department's satisfaction that the project cannot be constructed, or utilities relocated / constructed, within the right of way, easements and / or control of access as shown on the Right of Way Plans developed by the Department, the Department will bear the cost for the portion of the additional right of way, easement or control of access that is satisfactorily demonstrated by the Design-Build Team as needed to construct the facility.

The Department has negotiated a permanent easement through the Alcoa Power Generating, Inc. property based on the Right of Way Plans provided by the Department. However, this easement acquisition will not be completed until after the Right of Way Plans (along this property) are submitted by the Design-Build Team. At such time, the Department will proceed to finalize the acquisition of this permanent easement. The cost associated with finalizing this acquisition as well as the cost of the easement itself will be borne by the Department.

No right of way, easement or control of access acquisition will be allowed within the Yadkin River Crossings Historic District.

The Design-Build Team shall employ qualified, competent personnel who are currently **approved by the NCDOT Right of Way Branch** to provide all services necessary to perform all appraisal, appraisal review, negotiation and relocation services required for completion of the project in accordance with G.S. 136-28.1 of the General Statutes of North Carolina, as amended, and in accordance with the requirements set forth in the *Uniform Appraisal Standards and General Legal Principles for Highway Right of Way*, the *North Carolina Department of Transportation's Right of Way Manual*, the *North Carolina Department of Transportation's Rules and Regulations for the Use of Right of Way Consultants*, the *Code of Federal Regulations*, and *Chapter 133 of the General Statutes of North Carolina from Section 133-5 through 133-18*, hereby incorporated by reference, including the Uniform Relocation Assistance and Real Property Acquisition Policies Act of 1970, as amended. The Design-Build Team shall perform the services as set forth herein and furnish and deliver to the Department reports

accompanied by all documents necessary for the settlement of claims and the recordation of deeds, or necessary for condemnation proceedings covering said properties.

A Department representative will be available to provide technical guidance on right of way acquisition procedures and to make timely decisions on approving relocation benefits and approving administrative adjustment settlements on behalf of the Department over and above the authority granted to the Department Right of Way Consultant Project Managers.

The Design-Build Team shall submit a right of way project tracking report and right of way quality control plan to the Department. The Department standard forms and documents will be used to the extent possible.

The Design-Build Team shall provide a current title certificate for each parcel they acquire as of the date of closing or the date of filing of condemnation.

The Design-Build Team shall prepare, obtain execution of and record documents conveying title to acquired properties to the Department with Register of Deeds and deliver all executed and recorded deeds and easements to the Department. For all property purchased in conjunction with the project, title will be acquired in fee simple or easement and shall be conveyed to "The North Carolina Department of Transportation", free and clear of all liens and encumbrances except permitted encumbrances.

It is understood and agreed by and between the parties hereto that all reports, surveys, studies, specifications, memoranda, estimates, etc., secured by and for the Design-Build Team shall become and remain the sole property of the Department upon termination or completion of the work, and the Department shall have the right to use same for any public purpose without compensation to the Design-Build Team.

The Design-Build Team shall prepare appraisals in accordance with The Department's *Uniform Appraisal Standards and General Legal Principles for Highway Right of Way Acquisitions*. The Design-Build Team's appraiser must be on The Department's approved state certified appraiser list. The Design-Build Team may request its state certified appraiser be added to the approved state certified appraiser list, subject to approval by the Department's State Appraiser.

The Design-Build Team is to provide appraisal reviews complying with the Department's *Uniform Appraisal Standards and General Legal Principles for Highway Right of Way Acquisitions*. The reviewer must determine that the appraisal meets the Department's guideline and requirements, conforms to acceptable appraisal standards and techniques, does not include any non-compensable items or exclude any compensable items and that the value conclusions are reasonable and based on facts presented in the appraisal. The reviewer has the authority to approve, adjust, request additional data or corrections, or not to recommend and request another appraisal. The reviewer has the authority to approve appraisals not in excess of \$750,000.00. All appraisals showing compensation in excess of \$750,000.00 are referred to the Department's State Appraiser for approval, with the written recommendation of the reviewer. The Design-Build Team's reviewer must be on the Department's approved state certified reviewer appraiser list. The Design-Build Team may request its state certified review appraiser to be added to the

approved state certified reviewer appraiser list, subject to approval by the Department's State Appraiser.

The Design-Build Team shall provide a right of way certification prior to entering any property.

EROSION AND SEDIMENTATION CONTROL SCOPE OF WORK (12-21-09)

The NCDOT REU shall review and accept all Erosion and Sedimentation Control Plans. Clearing & Grubbing and Final Grade Release for Construction (RFC) Erosion Control Plans shall be submitted to all NCDOT Personnel listed in the Design-Build Submittal Guidelines before **any** land disturbing activities, including clearing and grubbing, can commence. If the Design-Build Team chooses to perform the work in discrete sections, then a complete set of Clearing & Grubbing and Final Grade RFC Erosion Control Plans shall be submitted, accepted, and distributed as noted above prior to land disturbing activities, including clearing and grubbing, commencing in that section. No land disturbing activities, including clearing and grubbing, shall occur in any location that does not have accepted Clearing & Grubbing and Final Grade RFC Erosion Control Plans. Refer to the most recent version of the *NCDENR - Erosion and Sediment Control Planning and Design Manual* for erosion control design guidelines not addressed in this Scope of Work.

Erosion and Sedimentation Control Plans shall at a minimum address the following:

I. Complete Set of Plans

A. Clearing and Grubbing Phase

1. Use correct NCDOT symbology
2. Protect existing drainage structure inlets with Rock Inlet Sediment Trap Type 'A' (RIST-A), Rock Inlet Sediment Trap Type 'C' (RIST-C), Rock Pipe Inlet Sediment Trap Type 'A' (PIST-A), etc.
3. Utilize adequate perimeter controls (temporary silt ditches (TSD), temporary silt fence (TSF), etc.)
4. Utilize skimmer basins and rock measures with sediment control stone (Temporary Rock Sediment Dam Type 'B' (TRSD-B), Temporary Rock Silt Check Type 'A' (TRSC-A), etc.) at drainage outlets
5. Take into account existing topography and show contour lines
6. Show 50-foot Environmentally Sensitive Area (ESA) on both sides of Yadkin River and unnamed tributaries to Yadkin River on Clearing & Grubbing EC Plans only
7. Utilize Temporary Rock Silt Checks Type 'B' (TRSC-B) to reduce velocity in existing ditches with spacing of 250 feet divided by percentage of ditch grade. Also utilize TRSC-Bs in proposed TSDs and temporary diversions (TD)
8. Protect existing streams; do not place erosion control devices in live streams
9. Provide adequate silt storage for 3600 cubic feet per disturbed acre and sediment basins shall be sized with surface area equal to 435 square feet per cubic foot per second (cfs) of the peak inflow rate, Q25, using 25-year peak rainfall data (*NCDENR - Erosion and Sediment Control Planning and Design Manual* or NOAA's National Weather Service web site http://hdsc.nws.noaa.gov/hdsc/pfds/orb/nc_pfds.html for partial duration (ARI) time series type). A Sediment Basin Designer Spreadsheet will be provided by the NCDOT Roadside Environmental Unit (REU) upon request.
10. Design Riser Basins to the following standards:

- a. Surface Area shall be determined by Equation $A(\text{sq. feet}) = Q25(\text{cfs}) * 435$
 - b. Volume requirement shall be 1800 cubic feet per disturbed acre draining to the riser basin
 - c. Riser Pipe shall have a cross-sectional area 1.5 times that of the barrel pipe
 - d. The riser pipe shall be non-perforated with a skimmer attached to the bottom of the pipe 1 ft. from the bottom of the basin
 - e. See *NCDENR- Erosion and Sediment Control Planning and Design Manual* for additional design criteria
11. Skimmer Basins shall provide adequate silt storage for 1800 cubic feet per disturbed acre with surface area equal to 325 square feet per cubic foot per second (cfs) of the peak inflow rate, Q25, using the 25-year peak rainfall data (*NCDENR - Erosion and Sediment Control Planning and Design Manual* or NOAA's National Weather Service web site http://hdsc.nws.noaa.gov/hdsc/pfds/orb/nc_pfds.html for partial duration (ARI) time series type). A Skimmer Basin Designer Spreadsheet will be provided by the NCDOT Roadside Environmental Unit (REU) upon request.
 12. The minimum and maximum length to width ratio of all Sediment Basins shall be 2:1 and 6:1, respectively.
 13. Coir Fiber Baffles shall be installed in all silt basins and sediment dams at drainage outlets. For silt basins with a 20-foot or longer length, three Coir Fiber Baffles shall be installed with a spacing of 1/4 the basin length. For silt basins with a length less than 20 feet, a minimum of two Coir Fiber Baffles shall be installed, with a spacing of 1/3 the basin length. The Design-Build Team will not be required to show the individual baffles on the Erosion Control Plans, but shall be required to incorporate the Coir Fiber Baffle Detail on the Erosion Control Plans.
 14. Include any culvert and / or pipe construction sequence plan sheets in the Clearing & Grubbing Erosion Control Plans; all pipes 48" or larger, or any combination of pipes that total 48" or more require a construction sequence. Prior to installation of pipes smaller than 48 inches in jurisdictional areas, the Design Build Team shall submit a phasing plan for managing the watercourse to the Resident Engineer for review and acceptance. The phasing plan shall be in accordance with the Best Management Practices for Construction and Maintenance Activities.
 15. Incorporate temporary sediment basins into permanent stormwater devices.
 16. Utilize Wattles with Polyacrylamide (PAM) and/or TRSC-A's with Matting and PAM in temporary and permanent, existing and proposed ditches at a spacing of 50 ft. in areas where sediment basins are not feasible at drainage outlets, and in areas where sediment basins at drainage outlets with sediment traps (i.e. PIST-A, RIST-A, etc.) cannot be properly sized to surface area and/or sediment storage requirements due to safety concerns, ROW limitations, utility conflicts, or other construction limitations approved by the Roadside Environmental Unit.

B. Final Grade Phase

1. Use correct NCDOT symbology
2. Protect existing and proposed drainage structure inlets with RIST-A, RIST-C, PIST-A, etc.
3. Utilize adequate perimeter controls (TSD, TSF, etc.)

4. Utilize TRSC-Bs to reduce velocity in existing and proposed ditches with spacing of 250 feet divided by percentage of ditch grade. Also utilize TRSC-Bs in proposed TSDs and TDs
5. Utilize temporary slope drains and earth berms at top of fill slopes 8 feet or higher and a fill slope grade of 3:1 or steeper, or where there are superelevations above 0.04 and fills are greater than 5 feet. Maximum slope drain spacing shall be 200 feet.
6. Utilize rock energy dissipater and / or silt basin at outlet of slope drain
7. Devices at all drainage turnouts shall utilize skimmer or sediment control stone (TRSD-B, TRSC-A, etc.) and a spillway with an adequately designed base length to distribute outflow
8. Provide adequate silt storage for 3600 cubic feet per disturbed acre and sediment basins shall be sized with surface area equal to 435 square feet per cubic foot per second (cfs) of the peak inflow rate, Q25, using 25-year peak rainfall data (*NCDENR - Erosion and Sediment Control Planning and Design Manual* or NOAA's National Weather Service web site http://hdsc.nws.noaa.gov/hdsc/pfds/orb/nc_pfds.html for partial duration (ARI) time series type). A Sediment Basin Designer Spreadsheet will be provided by NCDOT REU upon request
9. Provide matting for erosion control in all ditch lines where the velocity is greater than 2.0 ft./s, and the shear stress is 1.55 psf or less. For ditch lines with a shear stress above 1.55 psf, Permanent Soil Reinforcement Mat or Rip Rap shall be utilized
10. Provide matting for erosion control on all fill slopes 2:1 or steeper
11. Design Riser Basins to the following standards:
 - a. Surface Area shall be determined by Equation $A(\text{sq. feet}) = Q25(\text{cfs}) * 435$
 - b. Volume requirement shall be 1800 cubic feet per disturbed acre draining to the riser basin
 - c. Riser Pipe shall have a cross-sectional area 1.5 times that of the barrel pipe
 - d. The riser pipe shall be non-perforated with a skimmer attached to the bottom of the pipe 1 ft. from the bottom of the basin
 - e. See *NCDENR- Erosion and Sediment Control Planning and Design Manual* for additional design criteria
12. Skimmer Basins shall provide adequate silt storage for 1800 cubic feet per disturbed acre with surface area equal to 325 square feet per cubic foot per second (cfs) of the peak inflow rate, Q25, using the 25-year peak rainfall data (*NCDENR - Erosion and Sediment Control Planning and Design Manual* or NOAA's National Weather Service web site http://hdsc.nws.noaa.gov/hdsc/pfds/orb/nc_pfds.html for partial duration (ARI) time series type). A Sediment Basin Designer Spreadsheet will be provided by the NCDOT Roadside Environmental Unit (REU) upon request
13. The minimum and maximum length to width ratio of all Sediment Basins shall be 2:1 and 6:1, respectively
14. Coir Fiber Baffles shall be installed in all silt basins and sediment dams at drainage outlets. For silt basins with a 20-foot or longer length, three Coir Fiber Baffles shall be installed with a spacing of 1/4 the basin length. For silt basins with a length less than 20 feet, a minimum of two Coir Fiber Baffles shall be installed, with a spacing of 1/3 the basin length. The Design-Build Team will not be required to show the individual baffles on the Erosion Control Plans, but shall be required to incorporate the Coir Fiber Baffle Detail on the Erosion Control Plans

15. Incorporate temporary sediment basins into permanent stormwater devices.
16. Utilize Wattles with Polyacrylamide (PAM) and/or TRSC-A's with Matting and PAM in temporary and permanent, existing and proposed ditches at a spacing of 50 ft. in areas where sediment basins are not feasible at drainage outlets, and in areas where sediment basins at drainage outlets with sediment traps (i.e PIST-A, RIST-A, etc.) cannot be properly sized to surface area and/or sediment storage requirements due to safety concerns, ROW limitations, utility conflicts, or other construction limitations approved by the Roadside Environmental Unit.

C. Intermediate Phase

Intermediate Erosion Control Plans shall only be required if design modifications and / or site conditions require additional erosion control design or design revisions to the RFC Clearing and Grubbing and / or RFC Final Grade Erosion Control Plans. Intermediate Plans shall be submitted for review and shall be accepted prior to construction of any aspect impacted by the revised erosion control design. For any intermediate phase, comply with Section B, "Final Grade Phase" above.

II. Detail Sheets and Notes

- A. Provide project specific special notes and details such as temporary rock silt check type B, coir fiber baffle, skimmer basin, etc.
- B. Provide matting summary sheet(s): matting for erosion control and permanent soil reinforcement mat
- C. Provide reforestation sheet(s): regular, wetland, streambank and / or buffer showing appropriate species

III. Title Sheet

- A. Show correct notes: HQW, ESA, clearing and grubbing, etc.
- B. Show correct standards for project
- C. List of standard NCDOT symbology
- D. Show name and certification number of Level IIIA certified individual responsible for designing and/or reviewing Erosion and Sedimentation Control Plans

IV. Special Provisions

- A. Erosion Control Special Provisions are available at the following website:
http://www.ncdot.org/doh/operations/dp_chief_eng/roadside/soil_water/special_provisions/
- B. References in Erosion Control Special Provisions from the aforementioned website to Method of Measurement, Basis of Payment, or any other statement regarding direct payment for Erosion & Sediment Control measures shall be disregarded.
- C. Erosion Control / Stormwater Certification found elsewhere in this RFP.

V. Miscellaneous

- A. Plan submittals shall include all pertinent design information required for review, such as design calculations, drainage areas, etc.
- B. The NCDOT REU will provide a sample set of Erosion and Sedimentation Control Plans (including any special details or special provisions used by the NCDOT REU) and MicroStation Erosion Control Workspace to the Design-Build Team for reference upon request.
- C. Plans shall address any environmental issues raised during the permitting process.
- D. Sufficient time shall be allowed for the Design-Build Team to make any changes to the Erosion and Sedimentation Control Plans deemed necessary by the NCDOT REU.
- E. Temporary access and haul roads, other than public roads, constructed or used in connection with the project shall be considered a part of the project and addressed in the Erosion and Sedimentation Control Plans.
- F. Borrow or waste areas that are part of the project shall require a separate Reclamation Plan, unless the borrow or waste activity is regulated under the *Mining Act of 1971*, or is a landfill regulated by the Division of Solid Waste Management (NCDENR). The Design-Build Team shall submit the permit number for waste / borrow sites covered by the Mining Act or regulated by DSWM (DENR) concurrently to the Transportation Program Management Director and the Resident Engineer. For Reclamation Procedures, see:

http://www.ncdot.org/doh/operations/dp_chief_eng/roadside/fieldops/downloads/Files/ContractorReclamationProcedures.pdf

- G. Whenever the Engineer determines that significant erosion and sedimentation continues despite the installation of approved protective practices, the Design-Build Team shall be required to and shall take additional protective action.
- H. An accepted Erosion and Sedimentation Control Plan does not exempt the Design-Build Team from making every effort to contain sediment onsite.
- I. Any Erosion Control Design revisions made during the construction of the project shall be submitted to NCDOT REU by the 15th of the month via the Transportation Program Management Director. At anytime requested by the Engineer or the Roadside Environmental Unit, the Design-Build Team shall provide an updated version of the Erosion and Sedimentation Control Plans for distribution to all parties involved in the construction process.
- J. The Design-Build Team shall comply with the *North Carolina Administrative Code Title 15 A Department of Environment and Natural Resources Chapter 4, Sediment Control*.
- K. A pre-design meeting shall take place between the NCDOT REU Soil & Water Engineering Section, the Design Build Team, and any other pertinent NCDOT personnel before any Erosion and Sedimentation Control Designs are submitted to NCDOT REU. Erosion and Sedimentation Control Plan submittals shall only be reviewed and accepted by NCDOT REU after the Erosion Control Pre-Design Meeting. The Design Build Team shall be required to submit a tentative Erosion and Sedimentation Control Plan submittal schedule at the pre-design meeting.
- L. At minimum, the Design Build Team shall bring one erosion control plan sheet with a Clearing & Grubbing erosion control design to the Erosion and Sedimentation Control Plan pre-design meeting.

- M. All RFC Erosion and Sedimentation Control Plans, including any red line revisions, shall be kept on site at all times throughout the duration of the project.
- N. Erosion Control / Stormwater Certification shall be required according to the Project Special Provision found elsewhere in this RFP.
- O. Prior to installation of any erosion control devices, the Design-Build Team shall verify boundaries of jurisdictional areas in the field and delineated with Safety Fence.

EROSION CONTROL LIQUIDATED DAMAGES

The Design-Build Team shall observe and comply with Federal and State Laws, Local Laws, Ordinances, and Regulations; as well as Orders and Decrees of Bodies having any jurisdiction or authority in accordance with Section 107 of the 2006 *Standard Specifications for Roads and Structures*.

The Design-Build Team shall take all reasonable precautions to comply with all regulations of all authorities having jurisdiction over public and private land governing the protection of erosion and sedimentation. Any fines, remediation required or charges levied against the Department for failing to comply with all rules and regulations concerning erosion and sediment control, due to the Design-Build Team's negligence, carelessness, or failure to implement the Erosion and Sedimentation Control Plans and Specifications; or failure to maintain an approved Storm Water Pollution Prevention Plan (SWPPP), regardless of absence of neglect, shall be deducted from monies due the Design-Build Team. In addition to said fines, remediation required, or charges levied, any associated engineering costs or actions taken by the Department in order for the Department to comply with rules and regulations, as a result of the Design-Build Team's negligence, carelessness, or failure to implement the Erosion and Sedimentation Control Plans and Specifications; and / or the SWPPP, regardless of absence of neglect, shall be deducted from the monies due to the Design-Build Team.

LIGHTING SCOPE OF WORK (3-10-09)

Provide and install roadway lighting equipment and materials, in accordance with Division 1400 of the *2006 NCDOT Standard Specifications for Roads and Structures*, and the *Roadway Standard Drawings*, except as amended below. NCDOT will provide the lighting design.

If the Contractor redesigns the interchange, allow 10 days to update and finalize lighting design after Release for Construction (RFC) Roadway plans are complete and accepted by the Transportation Program Management Director. Provide electronic CADD files in MicroStation format, using Geopak Software (current version used by the Department) showing design changes.

Allow 10 days for Department review of each submittal for all materials including poles and foundation designs. An additional 10 days shall be required for pole submittals from vendors that do not commonly do business with the Department.

Maintain the lighting system until the project is accepted.

Reference the Traffic Management Scope of Work found elsewhere in this RFP for time restrictions and lane closure requirements.

MATERIALS

High Mount Standard

Amend paragraph five (5) of Section 1401-2 of the *2006 Standard Specifications for Roads and Structures* as follows:

Have the design of the support including base plate and anchorage conform to *2004 AASHTO Standard Specifications for Structural Supports for Highway Signs, Luminaires and Traffic Signals*, and the Interim Specifications valid at the time of letting. Fatigue Category II shall be used in design. The welding design and fabrication shall be in accordance with Article 1072-20 of the *2006 Standard Specifications for Roads and Structures*.

The support shall be designed for the wind velocity shown on the plans.

Light Control System

Amend Section 1408-2 of the *2006 Standard Specifications for Roads and Structures* as follows:

The completed light control system shall be marked "Suitable for Use as Service Equipment", in a prominent location in the enclosure, in accordance with NEC article 409.110.

Provide a polymer concrete (PC) junction box measuring 36"L x 24"W x 18"H (PC36) and meeting the requirements of Section 1411 of the Standard Specifications.

CONSTRUCTION

Wiring Methods

Amend Section 1400-4(F) of the *2006 Standard Specifications for Roads and Structures* to include the following:

Pull conductors by hand, or use motorized cable-pulling equipment designed for pulling multiple cables into conduit. Use sheaves or rollers, as required to prevent damage to conductor insulation. Do not use an automobile to generate cable pulling forces. Use equipment similar to the Greenlee model UT2 cable pulling system, or Engineer approved equal.

Inspections

Amend Section 1400-5 of the *2006 Standard Specifications for Roads and Structures* to include the following:

Provide the personnel and equipment necessary for removing and replacing fuseholders and/ or operating circuit breakers, to facilitate the insulation resistance test described elsewhere in the Special Provisions.

To minimize the potential for delays preparing the final inspection punch list, the Design-Build Team shall coordinate inspection of the items defined in the NCDOT LIGHTING SYSTEM INSPECTION CHECKLIST with the project inspector as work progresses and at the end of the project. Upon request, a copy of the NCDOT LIGHTING SYSTEM INSPECTION CHECKLIST will be provided.

Performance Tests

Amend Section 1400-6 of the *2006 Standard Specifications for Roads and Structures* to include the following:

Provide a calibrated MegOhmMeter, with certification that calibration was done recently (within one year of use). Provide a meter manufactured by Fluke, Amprobe, Biddle, or Engineer approved equal. Present the meter for inspection at the pre-lighting-work meeting described elsewhere in this Scope of Work.

Removing water from the conduit of a faulty circuit is not considered a repair. Water in the conduit allows current to flow between skinned places in the conductors insulation. If a circuit fails the insulation resistance test, and removing water allows the circuit to pass, replace the conductors and re-test the new circuit.

Construction Phasing

Amend Section 1400-11 of the *2006 Standard Specifications for Roads and Structures* to include the following:

Schedule a pre-lighting-work meeting before beginning work on the lighting system. Include staff members from the prime contractor, electrical sub-contractor, Resident Engineer's office, and the Lighting/ Electrical squad in the Roadway Design Unit in Raleigh.

High Mount Standard

Same as Section 1401-3 of the *2006 Standard Specifications for Roads and Structures* except as amended below:

Tighten anchor rod nuts in accordance with the Anchor Rod Nut Tightening Requirements section of the Project Special Provision for Overhead Sign Supports.

Light Control System

Amend Section 1408-3 of the *2006 Standard Specifications for Roads and Structures* to add the following:

Install PC36 junction box within 2' of edge of pad in front of Control System. Stub all feeder circuit conduits and spare conduits from Control System in this junction box. See plans for conduit sizes. Place pull cord in any unused conduits and cap unused conduit in junction box.

FINAL INSPECTION

Contact Lighting / Electrical engineers from NCDOT to inspect the completed lighting system and perform insulation resistance testing for all conductors prior to contract acceptance.

ELECTRICAL SERVICE

Coordinate with the local utility company, make application and pay all deposit fees to provide necessary electrical service. Refer to Utilities Coordination Scope of Work for additional coordination / approval requirements, payments and other costs.

MAINTENANCE

Assume responsibility for routine maintenance of the lighting system(s) for the duration of the contract in accordance with Section 1400 of the *2006 NCDOT Standard Specifications for Roads and Structures*, except as amended below.

NCDOT will pay the monthly power bills. NCDOT will assume maintenance responsibility for the completed lighting systems after the project is accepted, and there is no chance of construction-related damage.

ENVIRONMENTAL SCOPE OF WORK (12-21-09)

USACE 404 Permit and DWQ 401 Certification

NCDOT has been issued the Section 404 and 401 permits for this project. The permit expiration date has been extended to December 31, 2013. The Department has re-verified threatened and endangered species surveys on November 4, 2009.

Unless noted otherwise in this RFP, all work by the Design-Build Team must be accomplished in compliance with the permits and certifications issued by the agencies and as may be amended under permit modification(s). The Design-Build Team shall provide each of its contractors and/or agents associated with the construction or maintenance of this project with a copy of the permits. Unless otherwise noted in this RFP, the Design-Build Team shall also adhere to the commitments made as part of the Environmental Assessment, Finding of No Significant Impact, and all consultations.

The Design-Build Team shall identify in the Technical Proposal any changes to the design that may require permit modifications. All permit modifications or agency notifications needed as a result of these design changes shall be the responsibility of the Design-Build Team.

Federal Energy Regulatory Commission Approval

A construction permit is required for work within Alcoa Power Generating, Inc. (APGI) property or hydroplant project boundaries. NCDOT prepared a package to Alcoa Power Generating, Inc. (APGI-Yadkin) for this permit based on the design shown in the Right of Way Plans provided by the Department, which they in turn submitted to the Federal Energy Regulatory Commission. The Department will provide the correspondence in support of this effort. Approval of this application will occur shortly after the final easement agreement with APGI-Yadkin is executed. This easement acquisition will not be completed until after the Right of Way Plans (along this property) are submitted to the Department by the Design-Build Team. At such time, the Department will proceed to finalize the acquisition of this permanent easement. The Design-Build Team shall prepare design and construction information and supply to the Transportation Program Management Director to be submitted to APGI-Yadkin for their further conveyance to the Federal Energy Regulatory Commission (FERC). The FERC has 45 days to comment on the project information. The Design-Build Team shall be responsible for meeting all permit conditions imposed by FERC or APGI-Yadkin. In the event that the Design-Build Team's design does not require any revision to the easement through the APGI-Yadkin property as compared to that shown on the Department's Right of Way Plans, then the Department will proceed to finalize the easement and construction permit work immediately following contract execution.

Wetland Mitigation

The Department has prepared and provided a Restoration Plan for Swamp Hardwoods Wetlands, dated July 12, 2004 that was developed to accommodate the Right of Way Plans

provided by the Department. The Design-Build Team shall create mitigation where removing embankment adjacent to wetlands along the existing I-85 Yadkin River crossing's southern approach. On-site mitigation performed by the Design-Build Team shall conform to the following requirements:

The design of the wetland mitigation area shall consist of undercut excavation down to the alluvium soil layer as shown in the Subsurface Investigation Report. If the alluvium soil layer is encountered at an elevation above the adjacent existing wetland, excavation shall continue until the elevation matches the existing wetland elevation. If the alluvium soil layer is encountered below the adjacent existing wetland elevation, silty loam, sandy loam or muck shall be used to backfill these areas to match the existing wetland elevation. All excavated areas shall be ripped according to the provision provided below prior to placement of any backfill material. All areas shall be planted at 680 trees per acre with appropriate size and species as identified in the Restoration Plan for Swamp Hardwoods Wetlands, dated July 12, 2004. The Design-Build Team shall provide a design of the wetland mitigation area to PDEA-NEU and the Transportation Program Management Director for NCDOT review and approval. PDEA-NEU shall be contacted to provide construction oversight to ensure that the wetland mitigation area is constructed appropriately. The construction shall be conducted in strict compliance with all permit conditions. The post-construction monitoring proposed in the permit application will be NCDOT's responsibility. The Design-Build Team shall be responsible for maintaining the wetland mitigation area until the project is complete and accepted by the Department. No other warranty besides the Twelve Month Guarantee applies to this task.

Upon completion of grading, the areas to be planted with wetland reforestation shall be ripped with a "v" ripper tillage tool to a minimum depth of 15 inches. Each sequential swath of the equipment shall be consistent in spacing and shall have a maximum of 20 inches) between ripper (shank) rows.

The "V" ripper tillage tool shall have a minimum of three (3) shanks spaced a maximum of 20 inches apart and have shanks of sufficient length capable of providing a minimum depth of 15 inches. The tractor used to perform this work shall be of sufficient size and horsepower capable of pulling this implement to the minimum specifications stated above.

PUBLIC INFORMATION SCOPE OF WORK (12-21-09)

The Design-Build Team will take the lead role on this project and be responsible for the public information efforts through the NCDOT's IMPACT Public Information Program. The Design-Build Team's responsibilities will include:

- Organizing public meetings
- Providing media announcements
- Developing and producing informational print materials
- Soliciting and administering media advertisements, as deemed necessary
- Providing details surrounding the project impacts to the public
- Providing advance notice to the Department of upcoming project impacts
- Attending and/or speaking at public meetings
- Hand delivery of informational materials
- Facilitate regular Operations meetings
- Attend regular Incident Management meetings
- Mailings to the identified target audiences, including information development and postage.

NCDOT, through the IMPACT Public Information Program, will be responsible for reviewing and approving all of the public information materials created by the Design-Build Team for distribution for this project. The NCDOT will also be responsible for any postage necessary for mailings to the identified target audiences.

The Design-Build Team shall coordinate with the Department to promote public awareness for this project. This process begins with the development of a Public Information Plan for the project detailing target audiences, project impacts and proposed efforts to notify the public about the impacts. The Design-Build Team shall develop the specific list of target audiences for this project. The following groups are identified as typical target audiences to receive informational materials:

- Governmental agencies
- Municipalities directly affected by construction
- Transportation services
- Emergency services
- Neighborhood groups and private homes
- Industry and businesses
- Chamber of Commerce
- Individual schools effected by the project
- County/City school systems
- Any other organization as deemed necessary by the Department.

The Design-Build Team shall hold an initial project coordination meeting with NCDOT one month prior to start of construction to discuss project impacts to the public and the Public Information Plan.

The Design-Build Team shall inform the Department at least 3 weeks in advance of any construction activity that will have significant impact on the public, including the start of construction, major traffic shifts, road closures, ramp closures, detours, night work and project completion. At least 6 weeks advance notice shall be required prior to closing Bridge #392.

The amount of public information required for this project is directly based on the Design-Build Team's Traffic Control Plans and construction details. The minimum public information requirements solely associated with the Traffic Control Plans shall include, but not be limited to, the following:

- Public Meetings – If Beginning of Construction meeting for area businesses and residents is held, attending and/or speaking at this event.
- Distribution of Informational Materials - For beginning of construction and for all road/ramp closures with detour routes, the Design-Build Team shall be responsible for delivering time sensitive informational material provided by the NCDOT directly to portions of the target audience. Distribution responsibilities shall include all resources necessary to hand deliver the informational materials to the affected target audiences.

The Design-Build Team shall include in their Lump Sum Bid price for the project, all costs associated with their involvement in Public Information scope of work.

A web site is required for this project. All web site development must use the current NCDOT construction project web design template and must adhere to current software development, security and technical infrastructure standards. All web site design and implementation shall be coordinated with Mr. Ryan Nolan, Internet Web Content Manager, NCDOT Emerging Technologies. The Design-Build Team shall indicate in their Technical Proposal their intent to utilize a web site for this project.

***** PROJECT SPECIAL PROVISION *****

(10-18-95)

Z-1

PERMITS

The Design-Build Team's attention is directed to the following permits that have been issued to the Department of Transportation by the authority granting the permit.

<u>PERMIT</u>	<u>AUTHORITY GRANTING THE PERMIT</u>
Water Quality 401 Certification	DENR Division of Water Quality, State of North Carolina
Section 404 Permit	United States Army Corps of Engineers
Construction Permit within Yadkin River Hydroelectric Project Area	Alcoa Power Generating, Incorporated

The Design-Build Team shall comply with all applicable permit conditions during construction of this project. Agents of the permitting authority will periodically inspect the project for adherence to the permits.

The Design-Build Team's attention is also directed to Articles 107-10 and 107-14 of the *Standard Specifications* and the following:

Should the Design-Build Team propose to utilize construction methods (such as temporary structures or fill in waters and/or wetlands for haul roads, work platforms, cofferdams, etc.) not specifically identified in the permit (individual, general, or nationwide) authorizing the project it shall be the Design-Build Team's responsibility to coordinate with the Engineer to determine what, if any, additional permit action is required. The Design-Build Team shall also be responsible for initiating the request for the authorization of such construction method by the permitting agency. The request shall be submitted through the Engineer. The Design-Build Team shall not utilize the construction method until it is approved by the permitting agency. The request normally takes approximately 60 days to process; however, no extensions of time or additional compensation will be granted for delays resulting from the Design-Build Team's request for approval of construction methods not specifically identified in the permit.

Where construction moratoriums are contained in a permit condition which restricts the Design-Build Team's activities to certain times of the year, those moratoriums will apply only to the portions of the work taking place in the waters or wetlands provided that activities outside those areas is done in such a manner as to not affect the waters or wetlands.



REPLY TO
ATTENTION OF:

DEPARTMENT OF THE ARMY
WILMINGTON DISTRICT, CORPS OF ENGINEERS
69 DARLINGTON AVENUE
WILMINGTON, NORTH CAROLINA 28403-1343

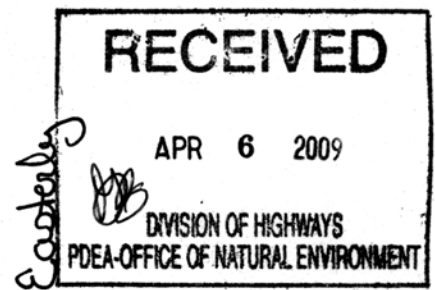

April 1, 2009

Regulatory Division

Action ID. 199821203; TIP No. I-239⁹4A

Dr. Gregory J. Thorpe, Ph.D.
Environmental Management Director, PDEA
N.C. Department of Transportation
1598 Mail Service Center
Raleigh, North Carolina 27699-1598

Dear Dr. Thorpe:

Reference is made to your Department of the Army (DA) permit issued on December 16, 2004, authorizing the discharge of fill material into waters of the United States (jurisdictional waters) for construction of Section A of the Interstate 85 (I-85) Improvements (T.I.P. No. I-2304A), from north of SR 2120 (Exit 81), northeast of Spence, in Rowan County, to north of I-85 Business (Exit 87), southwest of Lexington, in Davidson County, North Carolina. The project is adjacent to jurisdictional waters of the Yadkin River, Potts Creek, and unnamed tributaries of the Yadkin River.

Reference is also made to your written request of February 20, 2009, to extend your DA permit. As stated in your request the project was scheduled to start construction in 2004; however, funding for the project was cut and construction of the project was never started. At this time, new funding for the project is anticipated and the NCDOT plans to proceed with construction. The current DA permit for the project has an expiration date of December 31, 2009. It is expected that the project including the replacement and demolition of several bridges will take four years to complete. Therefore, you have requested a four year extension of your current DA permit. In accordance with your request, your permit is hereby extended until December 31, 2013. All other conditions of the original permit remain in full force and effect.

If the permitted work is not completed on or before the date herein specified, the authorization, if not previously revoked or specifically further extended, will cease and become null and void. If additional time is required to complete the project, you should contact this office with a request for an additional time extension.

Should you have questions, please contact Mr. John Thomas, Raleigh Regulatory Field Office, telephone (919) 554-4884 extension 25.

Sincerely,

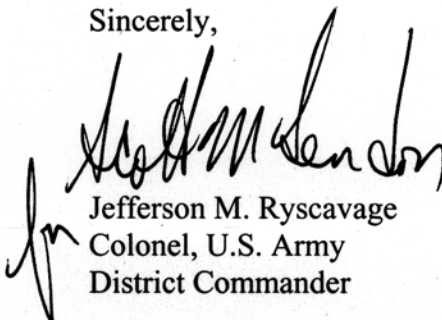

Jefferson M. Ryscavage
Colonel, U.S. Army
District Commander

Copies furnished:

Mr. Brian Wrenn
Division of Water Quality
North Carolina Department of Environment
and Natural Resources
1650 Mail Service Center
Raleigh, North Carolina 27699-1650

Mr. Travis Wilson
Eastern Region Highway Project Coordinator
Habitat Conservation Program
1142 I-85 Service Road
Creedmoor, North Carolina 27522

Mr. Pete Benjamin
U.S. Fish and Wildlife Service
Fish and Wildlife Enhancement
Post Office Box 33726
Raleigh, North Carolina 27636-3726

Mr. Chris Militscher
C/O FHWA
U.S. Environmental Protection Agency
Raleigh Office
310 New Bern Avenue, Room 206
Raleigh, North Carolina 27601

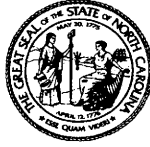

STATE OF NORTH CAROLINA
DEPARTMENT OF TRANSPORTATION

MICHAEL F. EASLEY
GOVERNOR

LYNDO TIPPETT
SECRETARY

December 23, 2004

MEMORANDUM TO: Mr. S. P. Ivey, P.E.
Division 9 Engineer

FROM: Philip S. Harris, III, P.E., Manager *PHS*
Office of Natural Environment
Project Development and
Environmental Analysis Branch

SUBJECT: Rowan-Davidson Counties, I-85 North of SR 2120 (Exit 81) in
Rowan County to US 29-52-70/I-85 Business (Exit 87) in
Davidson County; Federal Project No. NHF-85-3 (164) 80; State
Project No. 8.1631403; TIP Number I-2304A

Attached is the Individual Permit and a modification to the Division of Water Quality 401 Water Quality Certification for the above referenced project. All environmental permits have been received for the construction of this project.

PSH/gyb

Attachment

cc: Mr. Art McMillan, P.E.
Mr. Jay Bennett, P.E.
Mr. David Chang, P.E.
Mr. Randy Garris, P.E.
Mr. Greg Perfetti, P.E.
Mr. Mark Staley
Mr. John F. Sullivan, III, FHWA
Mr. Omar Sultan
Ms. Diane Hampton, P.E., Division 9 DEO

PROJECT COMMITMENTS

I-85

**North of SR 2120 (Exit 81) in Rowan County to
US 29-52-70/I-85 Business (Exit 87) in Davidson County
Rowan-Davidson Counties
Federal Aid Project No. NHF-85-3(164)80
State Project No. 8.1631403
T.I.P. Project No. I-2304A**

Commitments Developed Through Project Development and Design

Project Development and Environmental Analysis Branch (PDEA)

Because the subject project lies within a Federal Energy Regulatory Commission (FERC)-licensed hydroplant project boundary (the Yadkin Project), approval for land transfer must be obtained by NCDOT in the form of a FERC license revision. Coordination with the proper FERC officials shall take place, and the process to obtain a FERC permit will be followed.

Geotechnical Unit

It is anticipated that the proposed widening of I-85 and interchange reconstruction along I-85 will encroach on one property identified as an underground storage tank (UST) site. The project has been designed to minimize impacts to this UST site to prevent the possibility of long-term, costly remediation. This impacted site will be further evaluated before the project's construction.

Structure Design Unit

The Structure Design Unit will coordinate with the Norfolk Southern Corporation, Duke Power, and the North Carolina Railroad concerning the highway improvements affecting the freight railroads. The Structure Design Unit will also coordinate with NCDOT Rail Division, Norfolk Southern Corporation, and North Carolina Railroad for the future high-speed passenger rail corridor between Charlotte and Raleigh.

PDEA

Due to its historical significance, Bridge # 46, which carries US 29-70 over the Yadkin River in the southbound direction, will remain in place but will be closed to vehicular traffic. The bridge will remain in place to serve pedestrian and bicycle traffic. Ownership, liability, and maintenance responsibilities are currently being discussed by the Rowan and Davidson County Commissioners, the Transportation Museum, and the State Historic Preservation Office (SHPO). It is anticipated that these issues will be resolved before the project construction.

The issues related to ownership, liability, and maintenance responsibilities have not been resolved by the above-mentioned parties. These issues continue to be discussed by the local officials.

Right of Way Branch

It is anticipated that thirteen Geodetic Survey markers will be impacted by this project. The North Carolina Geodetic Survey will be contacted prior to construction regarding the relocation of survey markers along the project.

PDEA / Structure Design Unit

Removal of Bridge #137, which spans the Yadkin River, results in potentially 1,254 cubic yards of temporary fill. NCDOT will implement Best Management Practices for Bridge Demolition and Removal.

Upon further analysis of the amount of temporary fill resulting from bridge demolition, it was determined that only the amount of fill from the substructure would result in temporary fill. The likely potential amount of fill resulting from bridge demolition will be approximately 430 cubic yards. NCDOT will implement Best Management Practices for Bridge Demolition and Removal.

PDEA

The project may have an impact on a low income community in the Williams Trailer Park area located along I-85 south of SR 2124 (Hackett Road). During the project development process, no concerns have been raised by the public or local government officials concerning environmental justice issues. NCDOT will aggressively seek participation of this low-income community in the public involvement process.

NCDOT held two meetings with the citizens of the Williams Trailer Park. The first meeting was held in the Spencer Town Hall on 6/19/2001, and the second meeting was held in the North Carolina Transportation Museum on 6/24/2002. During these meetings, the design was presented to the trailer park residents, and their input and concerns related to the project were obtained. In addition to these meetings, a more detailed analysis was performed to determine the impacts to this area, and the determination has been made that this project does not create impacts related to Environmental Justice for the Williams Trailer Park.

PDEA / Design Services Unit

Based on preliminary studies, five areas were identified as possible noise barrier locations. These noise barriers were determined to be unreasonable, due to the cost of the noise reduction benefits versus the cost of the abatement measures. However, the project will be re-evaluated for noise abatement measures once more detailed designs are complete.

The project was re-evaluated for noise abatement measures. Noise mitigation in the form of a wall was analyzed for several areas along the project. For the I-2304AA section, one location, known as Barrier Location 2, it was determined that a barrier in this location is considered reasonable and feasible by NCDOT guidelines. Hence, a noise wall is recommended in this area. Further coordination with the affected residents and/or businesses will take place concerning this proposed noise wall.

PDEA / Design Services Unit/Construction Unit

A roadside memorial exists within the project limits, however it is not anticipated to be impacted by this project. This memorial, dedicated in 1929 by the North Carolina Historic Commission, which currently owns the property, was investigated for its historical significance. It was determined that this Trading Ford Monument is not eligible for the National Register of Historic Places. Based on this site visit and other information compiled by NCDOT, no additional archaeological work was deemed necessary for this site. The Historic Preservation Office has requested that the bronze plaque be returned to them if the monument has to be removed during construction. Additionally, NCDOT will coordinate with local officials and SHPO to determine if there is a more suitable location for the marker.

Design Services Unit / Structure Design Unit

In accordance with the FERC requirements, a Construction Permit will be issued to NCDOT once all requested information is reviewed and approved by FERC. The construction permit will contain a condition, among many others, that with regard to existing bridges, that NCDOT will be required to remove all concrete down to the existing muck line so that it will not be a hazard or act as a "catch" for floating debris.

PDEA

The biological conclusion for the bald eagle was revised to "Not Likely to Adversely Affect." This conclusion was approved by the USFWS. Because eagles may potentially nest in this area prior to bridge construction, NCDOT will re-survey for bald eagles prior to the project's construction.

Commitments Developed Through Permitting

Section 401 Water Quality Certification Conditions

Division 9, Roadside Environmental Unit (REU)

Sediment and erosion control measures shall not be placed in wetlands or waters to the maximum extent practicable. If placement of sediment and erosion control devices in wetlands and waters is unavoidable, they shall be removed and the natural grade restored within 30 days after the project has been released.

Division 9

Stormwater management shall be constructed in accordance with the hydraulic design plans submitted in the February 20, 2004 application.

Hydraulics Unit

The hazardous spill catch basins (I-2304AA Plan Sheet 9) shall be designed and located to afford ready access to maintenance and emergency response personnel and equipment.

- The volume of spill containment storage provided will be approximately 10,000 gallons plus the estimated runoff volume from rainfall intensity equating to a two-year return period event.
- A means will be provided such that the normal free flow of runoff at the basin outlet can be interrupted to cause containment of hazardous runoff. This can be accomplished by providing a mechanical control gate or by constructing a minimum control section in the outlet channel. The mechanical gate alternative will generally be utilized in areas where normal operational activities would allow close scrutiny and control, reducing the potential for problems with vandalism.
- Maintenance plans for constructed basins shall be developed in accordance with Best Management Practices (BMPs) and good engineering practices. Additional guidance for properly maintaining containment basins can be found at 40 CFR Part 112, §112.7, *et al.* (Spill Prevention Control and Countermeasures).
- Inspections of the hazardous spill catch basin and opening/shutting of the gate should be performed annually at a minimum, and within six (6) months after a spill incident to ensure integrity of the catch basin.
- Repairs should occur in a timely manner.
- NCDOT should provide annually, a site location map of all hazardous spill catch basins and similar devices to Federal (USEPA, USCG), DENR, State Emergency Response Coordinator, and all applicable county and urban center response groups.
- Signage indicating the presence of a hazardous spill catch basin shall be provided.

REU, Division 9

The removal of vegetation in riparian areas should be minimized. NCDOT is encouraged to use existing on-site vegetation and materials for stream bank stabilization and to minimize the use of rip rap. Rip rap shall not be placed in the stream bottom. Riparian vegetation, using native trees and shrubs, must be re-established within the construction limits of the project by the end of the growing season following completion of construction to re-establish the riparian zone and to provide long-term erosion control.

Division 9

Culverts that are less than 48-inch in diameter should be buried to a depth equal to or greater than 20% of their size to allow for aquatic life passage. Culverts that are 48-inch

diameter or larger should be buried at least 12 inches below the stream bottom to allow natural stream bottom material to become established in the culvert following installation and to provide aquatic life passage during periods of low flow. If any of the existing pipes are perched, they shall be removed and replaced, and re-installed correctly, unless demonstrated that this is topographically unfeasible.

PDEA

Summary of Compensatory Mitigation: Compensatory mitigation shall be the same as that approved by the US Army Corps of Engineers, as long as the mitigation required equals a ratio of 1:1 restoration or creation of lost wetland acres as described in 15A NCAC 2H.0506 (h)(6), and consists of the following:

I-2304 Section AA

- 0.02 acres of on-site riverine wetland restoration within I-2304 Section AA.
- 2644 linear feet of stream impacts will be mitigated through NCDENR Ecosystem Enhancement Program (EEP).
- 1.08 acres of impacts to non-riverine wetlands will be mitigated through EEP.

I-2304 Section AB

- 1.03 acres of on-site riverine wetland restoration within I-2304 Section AA.
- 1811 linear feet of stream will be mitigated through EEP.
- 0.16 acres of impacts to non-riverine wetlands will be mitigated through EEP.

In accordance with 15A NCAC 2R.0500, this contribution will satisfy NC Division of Water Quality's compensatory mitigation requirements under 15A NCAC 2H.0506(h). Until the EEP receives and clears NCDOT's payments, wetland or stream fill shall not occur. The payments to EEP shall be sent within two (2) months of issuance of the 404 permit.

Division 9, Design Services Unit, Hydraulics Unit

Two copies of the final construction drawings shall be furnished to NCDWQ prior to the pre-construction meeting. Written verification shall be provided that the final construction drawings comply with the permit drawings contained in the Application dated February 20, 2004 and May 11, 2004.

Division 9

The dimension, pattern and profile of the stream above and below the crossing should not be modified by widening the stream channel or reducing the depth of the stream. Disturbed floodplains and streams should be restored to natural geomorphic conditions. All stream relocation and restoration activities shall comply with the final natural channel design plans approved by the NC Division of Water Quality.

Division 9, REU

All channel relocations will be constructed in a dry work area, and stabilized before stream flows are diverted. Channel relocations will be completed and stabilized prior to diverting water into the new channel. Whenever possible, channel relocations shall be allowed to stabilize for an entire growing season. Vegetation used for bank stabilization shall be limited to native woody species, and should include establishment of a 30 foot wide wooded and an adjacent 20 foot wide vegetated buffer on both sides of the relocated channel to the maximum extent practical. A transitional phase incorporating coir fiber and seedling establishment is allowable. Also, rip-rap may be allowed if it is necessary to maintain the physical integrity of the stream, but NCDOT must provide written justification and any calculations used to determine the extent of rip-rap coverage requested.

All temporary fills in wetlands and surface waters shall be removed upon completion of the project. In addition, the post-construction removal of any temporary bridge structures or fill will need to return the project site to its pre-construction contours and elevations. The revegetation of the impacted areas with appropriate native species will be required.

Section 404 Individual Permit Conditions

Compliance With Plans

Division 9, Design Services Unit

All work must be performed in strict compliance with the plans, which are a part of the Section 404 permit. Any modification to the permit plans must be approved by the US Army Corps of Engineers (USACE) prior to implementation.

Construction Plans

NCDOT will ensure that the construction design plans for this project do not deviate from the permit plans. Written verification shall be provided that the final construction drawings comply with the attached permit drawings prior to any active construction in waters of the United States, including wetlands. Any deviation in the construction design plans will be brought to the attention of the Corps of Engineers, Raleigh Regulatory Field Office prior to any active construction in waters or wetlands.

Sedimentation and Erosion Control Measures

Division 9, REU

NCDOT shall remove all sediment and erosion control measures placed in wetlands or waters, and shall restore natural grades in those areas, prior to project completion.

Mitigation

PDEA

NCDOT shall mitigate for 2.29 acres of wetland impacts, and 4,455 linear feet of impact to streams with important aquatic function, for this project, as described below (1.05 acres of riverine bottomland hardwood wetland restoration at the Yadkin River Swamp Hardwoods Restoration Mitigation Site, and 2.48 acres of restoration equivalent non-riverine wetlands, and 8,910 linear feet of restoration equivalent warm water stream channel, through the North Carolina Ecosystem Enhancement Program (EEP), in the Yadkin River basin (Cataloging Unit 03040103).

YADKIN RIVER SWAMP HARDWOODS RESTORATION MITIGATION SITE

PDEA, Division 9, Roadside Environmental Unit

NCDOT shall implement the compensatory wetland mitigation plan entitled "Restoration Plan for Swamp Hardwoods Wetlands At Existing Bridge Causeway of the I-85 Yadkin River In Rowan County", dated July 12, 2004, to provide the restoration described in conditions below. NCDOT shall complete grading for the mitigation within one year of demolition of the existing I-85 Yadkin River bridge, and complete planting of the site within the first planting season (November 15 to March 15) after grading is completed. NCDOT shall contact the Corps of Engineers, Raleigh Regulatory Field Office NCDOT Regulatory Project Manager, a minimum of sixty days before completion of grading at the mitigation site, and inform the Project Manager of the expected completion date of the grading.

NCDOT shall mitigate for 1.05 acres of unavoidable impacts to riverine bottomland hardwood forest wetlands associated with this project with 1.05 acres of riverine bottomland hardwood forest wetland restoration, at the Yadkin River Swamp Hardwoods Restoration Mitigation Site (Yadkin Site).

NCDOT will do a boundary survey of the 1.05 acres of wetland restoration at the Yadkin Site, and submit a copy of the survey to the District Engineer within 90 days after construction of the site is completed.

NCDOT will monitor the site vegetation between June 1 and November 30, inclusively, of each year, and document plant mortality and stress. A minimum of one 0.05-acre sample plots will be established within the 1.05 acre restoration area, and will be placed randomly within a representative position. NCDOT will continue monitoring of the planting area annually until the specified performance criteria is met, as described below.

YADKIN SITE MITIGATION MONITORING

PDEA, Division 9, Roadside Environmental Unit

Performance criteria for tree planting areas will be met if sample plots demonstrate that for each of the first three complete years of monitoring, 320 target-species trees per acre

have survived, such that at the end of three years, 320 three-year old target-species trees per acre have survived on the site, and, in years four and five, 288 and 260 trees per acre, respectively, have survived on the site, such that at the end of year five, 260 five-year old target-species trees per acre have survived on the site.

If for any monitoring year, vegetation survival is not favorable, as determined by the Corps of Engineers, any remedial action required by the Corps of Engineers will be performed, the required restoration areas will be replanted, and the five-year monitoring period will begin again with year one.

GENERAL WETLANDS MITIGATION

PDEA, Division 9

NCDOT and subsequent property owners shall maintain the Yadkin Site in its natural condition, as altered by work in the mitigation plan, in perpetuity. Prohibited activities within the mitigation site specifically include, but are not limited to: the construction or placement of roads, walkways, buildings, signs, or structures of any kind (i.e., billboards, interior fences, etc.); filling, grading, excavation, leveling, or any other earth moving activity or activity that may alter the drainage patterns on the property; the cutting, mowing, destruction, removal, or other damage of any vegetation; disposal or storage of any debris, trash, garbage, or other waste material; except as may be authorized by the mitigation plans, or subsequent modifications that are approved by the Corps of Engineers. In addition, NCDOT shall take no action, whether on or off the mitigation property, which will adversely impact the wetlands on the mitigation property, except as specifically authorized by this permit, or subsequent modifications that are approved by the Corps of Engineers.

NCDOT shall make every effort to convey the Yadkin Site property to a nonprofit conservation organization or a natural resource agency, which is willing to hold the areas in perpetuity for conservation purposes, and which is acceptable to the Corps of Engineers. The annual monitoring reports, as required, will include the status of the conveyance efforts.

NCDOT shall not sell or otherwise convey any interest in the property used to satisfy mitigation requirements for this permit, to any third party, without 10 days prior notification to Wilmington District Corps of Engineers in writing, which writing shall reference this permit Action ID number.

Any sale, lease, or other conveyance of the mitigation site property shall include restrictions on the use of the property as described in conditions above, which conditions shall be enforced by the North Carolina Department of Transportation. Such restrictions shall include language providing for third party enforcement rights in favor of the Corps of Engineers. Such restrictions must be approved prior to conveyance by the Corps of Engineers.

GENERAL MITIGATION

PDEA

NCDOT shall contact the Corps of Engineers, Raleigh Regulatory Field Office NCDOT Regulatory Project Manager, to provide that individual with the opportunity to attend the yearly mitigation monitoring efforts.

NC-EEP STREAM AND WETLAND MITIGATION:

PDEA

Compensatory mitigation for the unavoidable impacts to 1.24 acres of non-riverine wetlands, and 4,455 linear feet of stream associated with the proposed project shall be provided by the Ecosystem Enhancement Program (EEP), as outlined in the letter dated April 30, 2004 from William D. Gilmore, EEP Transition Manager. Pursuant to the EEP Memorandum of Agreement (MOA) between the State of North Carolina and the US Army Corps of Engineers signed on July 22, 2003, the EEP will provide 2.48 acres of restoration equivalent non-riverine wetlands, and 8,910 linear feet of restoration equivalent warm water stream channel in the Yadkin River basin (Cataloging Unit 03040103) by one year of the date of this permit. For wetlands, a minimum of 1:1 (impact to mitigation) must be in the form of wetland restoration. The NCDOT shall, within 30 days of the issue date of this permit, certify that sufficient funds have been provided to EEP to complete the required mitigation, pursuant to Paragraph V. of the MOA.

Navigation

Division 9, Hydraulics Unit, Structure Design Unit

The authorized fill and structures, and associated activities, in the Yadkin River must not interfere with the public's right to free navigation on the river. No attempt will be made by NCDOT to prevent the full and free use by the public of the river at or adjacent to the authorized work for reason other than safety. NCDOT shall not modify the design of the temporary work bridges to provide an unobstructed main channel less than fifty feet wide, with no vertical structural obstructions from the work bridges extending into the opening.

Construction Plans

Division 9, Hydraulics Unit, Design Services Unit

Prior to commencing construction within jurisdictional waters of the United States, NCDOT shall forward the latest version of project construction drawings to the USACE, Raleigh Regulatory Field Office NCDOT Regulatory Project Manager. Half-size drawings are acceptable.

Historic Property

Division 9, PDEA

NCDOT shall leave Bridge No. 46, which currently carries US 29-70 over the Yadkin River in the southbound direction, in place, due to its historical significance. NCDOT shall close the bridge to vehicular traffic, but it will serve pedestrian and bicycle traffic. NCDOT shall work out ownership and maintenance responsibilities with the Rowan and Davidson County Commissioners, the Transportation Museum, and the North Carolina State Historic Preservation Office



Haney

Michael F. Easley, Governor
William G. Ross Jr., Secretary
North Carolina Department of Environment and Natural Resources

AB

Alan W. Klimek, P.E., Director
Division of Water Quality
Coleen H. Sullins, Deputy Director
Division of Water Quality

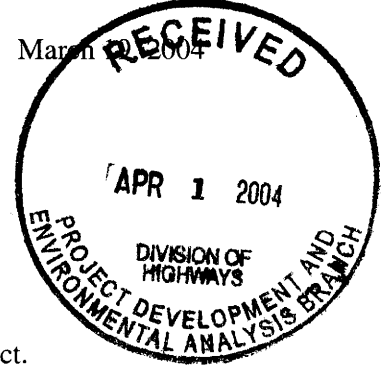

Mr. Gregory J. Thorpe, Ph.D., Environmental Director
NCDOT Planning and Environmental Branch
1548 Mail Service Center
Raleigh, NC, 27699-1548

Dear Dr. Thorpe:

Re: Water Quality Certification Pursuant to §401 of the Federal Clean Water Act.
Improvements to I-85 from north of SR 2120 in Rowan County to north of I-85 Business in Davidson County.
F.A. Project No. NHF-85-3(164)80; State Project No. 8.1631403
✓ TIP No. I-2304AA and I-2304AB
DWQ Project No. 040275

Attached hereto is a copy of Certification No. 3455 issued to The North Carolina Department of Transportation dated March 19, 2004.

If we can be of further assistance, do not hesitate to contact us.

Sincerely,

Alan W. Klimek, P.E.

Attachments

- cc: Wilmington District Corps of Engineers
- Eric Alsmeyer, USACE Raleigh Field Office
- NCDWQ Winston-Salem Regional Office
- Christopher Militscher, US Environmental Protection Agency – Region IV
- William Gilmore, NC Ecological Enhancement Program
- Central Files
- File Copy



- : Gregory J. Thorpe, Ph.D.
- . §401 Water Quality Certification No. 3455
- . I-2304 AA and I-2304 BA

NORTH CAROLINA 401 WATER QUALITY CERTIFICATION

THIS CERTIFICATION is issued in conformity with the requirements of Section 401 Public Laws 92-500 and 95-217 of the United States and subject to the North Carolina Division of Water Quality (DWQ) Regulations in 15 NCAC 2H, .0500. This Certification authorizes the NCDOT to incur the following permanent impacts:

I-2304 Section AA

- 0.02 acres of riverine wetlands through excavation and mechanized clearing;
- 1.08 acres of non-riverine wetlands through fill and mechanized clearing;
- 2644 linear feet of jurisdictional stream loss.

I-2304 Section AB

- 1.03 acres of riverine wetlands through fill, excavation, and mechanized clearing.
- 0.16 acres of non-riverine wetlands through fill and mechanized clearing.
- 1811 linear feet of jurisdictional stream loss;
- 0.003 acres of ponds (filling or draining).

The I-2304AA and I-2304AB projects shall be constructed pursuant to the application dated February 20, 2004 to improve I-85 from north of SR 2120 in Rowan County to north of I-85 Business in Davidson County.

The Application provides adequate assurance that the discharge of fill material into the waters of the state with the proposed development will not result in a violation of applicable Water Quality Standards and discharge guidelines. Therefore, the State of North Carolina certifies that this activity will not violate the applicable portions of Sections 301, 302, 303, 306, 307 of PL 92-500 and PL 95-217 if conducted in accordance with the application and conditions hereinafter set forth.

This approval is only valid for the purpose and design that you submitted in your Application. All work authorized by this Certification must be done in strict compliance with the plans attached to the Application. If this project changes, incurring additional impacts to streams, wetlands or buffers, you are required to notify the DWQ *in writing*, and you may be required to submit a new application. Additional compensatory mitigation may be required as described in 15A NCAC 2H .0506 (h) (6) and (7). For this approval to remain valid, you are required to comply with all the conditions listed below. In addition, you should obtain all other federal, state or local permits before proceeding with your project including (but not limited to) Sediment and Erosion Control, Non-discharge and Water Supply watershed regulations.

This Certification shall expire three (3) years from the date of the cover letter from DWQ or on the same day as the expiration date of the corresponding US Army Corps of Engineers Permit, whichever is later.

Condition(s) of Certification:

1. Erosion and sediment control practices must be in full compliance with all specifications governing the proper design, installation and operation and maintenance of such Best Management Practices in order to protect surface waters standards:
 - a. The erosion and sediment control measures for the project must be designed, installed, operated, and maintained in accordance with the most recent version of the *North Carolina Sediment and Erosion Control Planning and Design Manual*.
 - b. The design, installation, operation, and maintenance of the sediment and erosion control measures must be such that they equal, or exceed, the requirements specified in the most recent version of the *North Carolina Sediment and Erosion Control Manual*. The devices shall be maintained on all construction sites, borrow sites, and waste pile (spoil) projects, including contractor-owned or leased borrow pits associated with the project.
 - c. For borrow pit sites, the erosion and sediment control measures must be designed, installed, operated, and maintained in accordance with the most recent version of the *North Carolina Surface Mining Manual*.
 - d. Any reclamation measures and implementation must comply with the reclamation in accordance with the requirements of the Sedimentation Pollution Control Act.
2. No waste, spoil, solids, or fill of any kind shall occur in wetlands, waters, or riparian areas beyond the footprint of the impacts depicted in the Application. All construction activities shall be performed so that no violations of state water quality standards, statutes, or rules occur.
3. Sediment and erosion control measures shall not be placed in wetlands or waters to the maximum extent practicable. If placement of sediment and erosion control devices in wetlands and waters is unavoidable, they shall be removed and the natural grade restored within 30 days after the project has been released.
4. Stormwater management shall be constructed in accordance with the hydraulic design plans submitted in the February 20, 2004 application.
5. The hazardous spill catch basins (I-2304AA Plan Sheet 9) shall be designed and located to afford ready access to maintenance and emergency response personnel and equipment.
 - The volume of spill containment storage provided will be approximately 10,000 gallons plus the estimated runoff volume from rainfall intensity equating to a two-year return period event.
 - A means will be provided such that the normal free flow of runoff at the basin outlet can be interrupted to cause containment of hazardous runoff. This can be accomplished by providing a mechanical control gate or by constructing a minimum control section in the outlet channel. The mechanical gate alternative will generally be utilized in areas where normal operational activities would allow close scrutiny and control, reducing the potential for problems with vandalism.
 - Maintenance plans for constructed basins shall be developed in accordance with Best Management Practices (BMPs) and good engineering practices. Additional guidance for properly maintaining containment basins can be found at 40 CFR Part 112, §112.7, *et al.* (Spill Prevention Control and Countermeasures).
 - Inspections of the hazardous spill catch basin and opening/shutting of the gate should be performed annually at a minimum, and within six (6) months after a spill incident to ensure integrity of the catch basin.
 - Repairs should occur in a timely manner.

- NCDOT should provide annually, a site location map of all hazardous spill catch basins and similar devices to Federal (USEPA, USCG), DENR, State Emergency Response Coordinator, and all applicable county and urban center response groups.
 - Signage indicating the presence of a hazardous spill catch basin shall be provided.
6. The outside wetland or water boundary as well as along the construction corridor within these boundaries approved under this authorization shall be clearly marked by orange fabric fencing for the areas that have been approved to infringe within the wetland or water prior to any land disturbing activities.
 7. NCDOT and its contractors and/or agents shall not excavate, fill, or perform mechanized land clearing at any time in the construction or maintenance of this project within waters and/or wetlands, except as authorized by this Certification, or any modification to this Certification. There shall be no excavation from or waste disposal into jurisdictional wetlands or waters associated with this Certification without appropriate modification. If this occurs, compensatory mitigation will be required since it is a direct impact from road construction activities.
 8. Excavation of stream crossings should be conducted in the dry unless demonstrated by the applicant or its authorized agent to be unfeasible. Sandbags, cofferdams, flexible pipe, or other diversion structures should be used to minimize excavation in flowing water.
 9. Live or fresh concrete shall not come into contact with waters of the state until the concrete has hardened.
 10. Discharging hydroseeding mixtures and washing out hydroseeders and other equipment in or adjacent to surface waters is strictly prohibited.
 11. The removal of vegetation in riparian areas should be minimized. NCDOT is encouraged to use existing on-site vegetation and materials for stream bank stabilization and to minimize the use of rip rap. Riprap shall not be placed in the stream bottom. Riparian vegetation, using native trees and shrubs, must be re-established within the construction limits of the project by the end of the growing season following completion of construction to reestablish the riparian zone and to provide long-term erosion control.
 12. Culverts that are less than 48-inch in diameter should be buried to a depth equal to or greater than 20% of their size to allow for aquatic life passage. Culverts that are 48-inch diameter or larger should be buried at least 12 inches below the stream bottom to allow natural stream bottom material to become established in the culvert following installation and to provide aquatic life passage during periods of low flow. If any of the existing pipes are perched, they shall be removed and replaced, and re-installed correctly, unless demonstrated that this is topographically unfeasible.
 13. Heavy equipment should be operated from the bank rather than in the stream channel unless demonstrated by the applicant or its authorized agent to be unfeasible. All mechanized equipment operated near surface waters should be inspected and maintained regularly to prevent contamination of stream waters from fuels, lubricants, hydraulic fluids or other toxic substances.
 14. *Summary of Compensatory Mitigation:* Compensatory mitigation shall be the same as that approved by the US Army Corps of Engineers, as long as the mitigation required equals a ratio of 1:1 restoration or creation of lost wetland acres as described in 15A NCAC 2H.0506 (h)(6), and consists of the following:

I-2304 Section AA

- 0.02 acres of on-site riverine wetland restoration within I-2304 Section AA
- 2644 linear feet of stream impacts will be mitigated through NCDENR Ecosystem Enhancement Program (EEP).
- 1.08 acres of impacts to non-riverine wetlands will be mitigated through EEP.

I-2304 Section AB

- 1.03 acres of on-site riverine wetland restoration within I-2304 Section AA.
- 1811 linear feet of stream will be mitigated through EEP.
- 0.16 acres of impacts to non-riverine wetlands will be mitigated through EEP.

In accordance with 15A NCAC 2R.0500, this contribution will satisfy NC Division of Water Quality's compensatory mitigation requirements under 15A NCAC 2H.0506(h). Until the EEP receives and clears your payments, wetland or stream fill shall not occur. The payments to EEP shall be sent within two (2) months of issuance of the 404 permit.

15. Rock check dams at culvert outlets should be removed at project completion to avoid blocking movement of aquatic life.
16. Two copies of the final construction drawings shall be furnished to NCDWQ prior to the pre-construction meeting. Written verification shall be provided that the final construction drawings comply with the attached permit drawings contained in the Application dated February 20, 2004.
17. Upon completion of the project, the NCDOT shall complete and return the enclosed "Certification of Completion Form" to notify DWQ when all work included in the 401 Certification has been completed. The responsible party shall complete the attached form and return it to the 401/Wetlands Unit of the Division of Water Quality upon completion of the project.
18. NCDOT and its authorized agents shall conduct its activities in a manner consistent with State water quality standards and any other appropriate requirements of State law and Federal law. If DWQ determines that such standards or laws are not being met (including the failure to sustain a designated or achieved use) or that State or federal law is being violated, or that further conditions are necessary to assure compliance, DWQ may reevaluate and modify this Certification to include conditions appropriate to assure compliance with such standards and requirements in accordance with 15A NCAC 2H.0507(d). Before modifying the Certification, DWQ shall notify NCDOT and the US Army Corps of Engineers, provide public notice in accordance with 15A NCAC 2H.0503 and provide opportunity for public hearing in accordance with 15A NCAC 2H.0504. Any new or revised conditions shall be provided to NCDOT in writing, shall be provided to the United States Army Corps of Engineers for reference in any permit issued pursuant to Section 404 of the Clean Water Act, and shall also become conditions of the 404 Permit for the project.

NCDOT shall require its contractors (and/or agents) to comply with all of the terms of this Certification, and shall provide each of its contractors (and/or agents) a copy of this Certification.

Violations of any condition herein set forth may result in revocation of this Certification and may result in criminal and/or civil penalties. This Certification shall become null and void unless the above conditions are made conditions of the Federal Permit. This Certification shall expire upon the expiration of the 404 Permit.

Gregory J. Thorpe, Ph.D.
§401 Water Quality Certification No. 3455
I-2304 AA and I-2304 BA

If you do not accept any of the conditions of this certification, you may ask for an adjudicatory hearing. You must act within 60 days of the date that you receive this letter. To ask for a hearing, send a written petition that conforms to Chapter 150B of the North Carolina General Statutes to the Office of Administrative Hearings, 6714 Mail Service Center, Raleigh, N.C. 27699-6714. This certification and its conditions are final and binding unless you ask for a hearing.

This the 19th day of March 2004

DIVISION OF WATER QUALITY

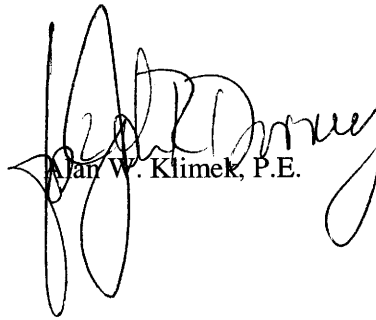

Alan W. Klimek, P.E.

WQC No. 3455

**NORTH CAROLINA – DIVISION OF WATER QUALITY
401 WATER QUALITY CERTIFICATION
SUMMARY OF PERMITTED IMPACTS AND MITIGATION REQUIREMENTS**

In accordance with 15A NCAC 2H.0500, NCDOT, DWQ Project No. 040275, is authorized to impact the surface waters of the State of North Carolina as indicated below for the purpose of improving I-85 from north of SR 2120 in Rowan County to north of I-85 Business in Davidson County. All activities associated with these authorized impacts must be conducted in accordance with the conditions listed in the attached Certification transmittal letter. **THIS CERTIFICATION IS NOT VALID WITHOUT THE ATTACHMENTS.**

Summary of Impacts

I-2304 Section AA

- 0.02 acres of riverine wetlands through excavation and mechanized clearing;
- 1.08 acres of non-riverine wetlands through fill and mechanized clearing;
- 2644 linear feet of jurisdictional stream loss.

I-2304 Section AB

- 1.03 acres of riverine wetlands through fill, excavation, and mechanized clearing.
- 0.16 acres of non-riverine wetlands through fill and mechanized clearing.
- 1811 linear feet of jurisdictional stream loss;
- 0.003 acres of ponds (filling or draining).

On-site mitigation to be performed by NCDOT:

- 0.02 acres of on-site riverine wetland restoration within I-2304 Section AA.
- 1.03 acres of on-site riverine wetland restoration within I-2304 Section AA.

COMPENSATORY MITIGATION REQUIREMENTS:

LOCATION: I-85

COUNTY: Davidson and Rowan Counties

BASIN/SUBBASIN: Yadkin-Pee Dee, Hydrologic Unit 03040103

As required by 15A NCAC 2B .0250 and 15A NCAC 2H .0506(h), and the conditions of this Certification, you are required to compensate for the above impacts through the restoration, creation, enhancement or preservation of wetlands, buffers, and surface waters as outlined below *prior* to conducting any activities that impact or degrade waters of the state. Mitigation to be performed by NC Ecological Enhancement Program in Hydrologic Unit 03040103:

- 4455 linear feet of stream impacts.
- 1.24 acres of impacts to non-riverine wetlands.

One of the options you have available to satisfy the compensatory mitigation requirements is through payment of a fee to the Ecosystem Enhancement Program per 15A NCAC 2R .0503. If you choose this option, please sign this form and mail it to the address listed below. An invoice for the appropriate amount of payment will be sent to you upon receipt of this form. **PLEASE NOTE, THE ABOVE IMPACTS ARE NOT AUTHORIZED UNTIL YOU RECEIVE NOTIFICATION THAT YOUR PAYMENT HAS BEEN PROCESSED BY THE ECOSYSTEM ENHANCEMENT PROGRAM.**

Signature

Date

ECOSYSTEM ENHANCEMENT PROGRAM
1652 Mail Service Center
RALEIGH, NC, 27699-1652



DWQ Project No.: _____ County: _____
Applicant: _____
Project Name: _____
Date of Issuance of 401 Water Quality Certification: _____

Certificate of Completion

Upon completion of all work approved within the 401 Water Quality Certification or applicable Buffer Rules, and any subsequent modifications, the applicant is required to return this certificate to the 401/Wetlands Unit, North Carolina Division of Water Quality, 1650 Mail Service Center, Raleigh, NC, 27699-1650. This form may be returned to DWQ by the applicant, the applicant's authorized agent, or the project engineer. It is not necessary to send certificates from all of these.

Applicant's Certification

I, _____, hereby state that, to the best of my abilities, due care and diligence was used in the observation of the construction such that the construction was observed to be built within substantial compliance and intent of the 401 Water Quality Certification and Buffer Rules, the approved plans and specifications, and other supporting materials.

Signature: _____ Date: _____

Agent's Certification

I, _____, hereby state that, to the best of my abilities, due care and diligence was used in the observation of the construction such that the construction was observed to be built within substantial compliance and intent of the 401 Water Quality Certification and Buffer Rules, the approved plans and specifications, and other supporting materials.

Signature: _____ Date: _____

If this project was designed by a Certified Professional

I, _____, as a duly registered Professional _____ (i.e., Engineer, Landscape Architect, Surveyor, etc.) in the State of North Carolina, having been authorized to observe (periodically, weekly, full time) the construction of the project, for the Permittee hereby state that, to the best of my abilities, due care and diligence was used in the observation of the construction such that the construction was observed to be built within substantial compliance and intent of the 401 Water Quality Certification and Buffer Rules, the approved plans and specifications, and other supporting materials.

Signature _____ Registration No. _____ Date _____





Harvey

November 22, 2004

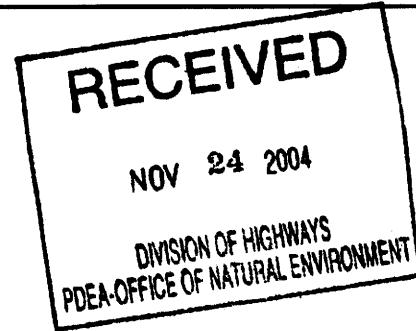

Dr. Gregory J. Thorpe, PhD., Manager
Planning and Environmental Branch
North Carolina Department of Transportation
1548 Mail Service Center
Raleigh, North Carolina, 27699-1548

Re: Modification of 401 Water Quality Certification Pursuant to Section 401 of the Federal Clean Water Act, Individual Permit Improvements to I-85 from north of SR2120 in Rowan County to north of NC 150 in Davidson County, TIP No. I-2304AA and AB
WQC No. 3455

Dear Dr. Thorpe:

Attached hereto is a copy of the Modification of Certification No. 3455 issued to The North Carolina Department of Transportation dated March 19, 2004. If we can be of further assistance, do not hesitate to contact us.

Sincerely,

Alan W. Klimek, P.E.
Director

Attachments

cc: Wilmington District US Army Corps of Engineers
Mr. Eric Alsmeyer, Corps of Engineers Raleigh Field Office
Mr. Christopher Militscher, US Environmental Protection Agency – Region IV
Mr. William Gilmore, P.E. Transition Manager, NC DENR Ecosystem Enhancement Program
Sue Homewood, NC DWQ Winston-Salem Regional Office
Central Files
File Copy

APPROVAL OF 401 Water Quality Certification and ADDITIONAL CONDITIONS

THIS CERTIFICATION is issued in conformity with the requirements of Section 401 Public Laws 92-500 and 95-217 of the United States and subject to the North Carolina Division of Water Quality (DWQ) Regulations in 15 NCAC 2H, Section .0500, and 15 NCAC 2B .0233. This certification authorizes the NCDOT for the following impacts:

Wetland Impacts in the Yadkin-Pee Dee River Basin

Section	Riverine (acres)	Non- Riverine (acres)	Total (acres)	On-Site Wetland Restoration (acres)	Mitigation Required (acres)
Section AA (authorized under original WQC)					
Excavation and Mechanized Clearing	0.02	0	0.02	0.02	0
Fill and Mechanized Clearing	0	1.08	1.08	0	1.08
Subtotal	0.02	1.08	1.10	0.02	1.08
Additional Impacts for this modification					
Fill	0.1	0	0.1	0.1	0
Total Section AA Impacts	0.12	1.08	1.20	0.12	1.08
Section AB (authorized under original WQC)					
Fill, Excavation and Mechanized Clearing	1.03	0	1.03	1.03	0
Fill and Mechanized Clearing	0	0.16	0.16	0	0.16
Subtotal	1.03	0.16	1.19	1.03	0.16
Additional Impacts for this modification					
Fill	0	0	0	0	0
Total Section AB Impacts	1.03	0.16	1.19	1.03	0.16

Surface Water Impacts for the Yadkin-Pee Dee River Basins

Section	Ponds (acres)	Stream Impacts (linear feet)	Stream Impacts (acres)	Stream Impacts Requiring Mitigation (linear feet)	On-Site Natural Channel Design (linear feet)	Mitigation Required
Section AA (authorized under original WQC)	0	2,644	0	2,644	0	2,644
Additional Impacts for this modification	0	0	0.15	0	0	0
Total for Section AA	0	11,104	0.15	11,104	0	2,644
Section AB (authorized under original WQC)	0.003	1,811	0	1,811	0	1,811
Additional Impacts for this modification	0	0	0	0	0	0
Total for Section AB	0.003	1,811	0	1,811	0	1,811

The project shall be constructed pursuant to the application filed on the October 11, 2004. The application provides adequate assurance that the discharge of fill material into the waters of the Yadkin-Pee Dee River Basins in conjunction with the proposed development will not result in a violation of applicable Water Quality Standards and discharge guidelines. Therefore, the State of North Carolina certifies that this activity will not violate the applicable portions of Sections 301, 302, 303, 306, 307 of PL 92-500 and PL 95-217 if conducted in accordance with the application and conditions hereinafter set forth.

This approval is only valid for the purpose and design that you submitted in your application, as described in the Public Notice. Should your project change, you are required to notify the DWQ and submit a new application. If the property is sold, the new owner must be given a copy of this Certification and approval letter, and is thereby responsible for complying with all the conditions. If additional wetland impacts, or stream impacts, for this project (now or in the future) exceed one acre or 150 linear feet, respectively, additional compensatory mitigation may be required as described in 15A NCAC 2H .0506 (h) (6) and (7). For this approval to remain valid, you are required to comply with all the conditions listed below. In addition, you should obtain all other federal, state or local permits before proceeding with your project including (but not limited to) Sediment and Erosion control, Coastal Stormwater, Non-discharge and Water Supply watershed regulations. This Certification shall expire three years from the date of the cover letter from DWQ or on the same day as the expiration date of the corresponding Corps of Engineers Permit, whichever is sooner.

Condition(s) of Certification:

Project Specific Conditions of Certification:

1. We understand that you have chosen to perform compensatory mitigation for impacts to wetlands and streams through an in-lieu payment to the North Carolina Ecosystem Enhancement Program (NCEEP), and that the NCEEP has agreed to implement the mitigation for the project. NCEEP has indicated in a letter dated August 26, 2004 that they will assume responsibility for satisfying the federal Clean Water Act compensatory mitigation requirements for the above-referenced project as detailed in the table below.

Type of Impact	Amount of Impact
Non-Riverine Wetlands	1.24 ac
Streams	4,455 lf

General Conditions of Certification:

2. The dimension, pattern and profile of the stream above and below the crossing should not be modified by widening the stream channel or reducing the depth of the stream. Disturbed floodplains and streams should be restored to natural geomorphic conditions. All stream relocation and restoration activities shall comply with the final natural channel design plans approved by the NC Division of Water Quality.
3. Construction will be conducted in such a manner as to prevent a significant increase in turbidity outside the area of construction or construction-related discharge. Erosion and sediment control practices must be in full compliance with all specifications governing the proper design, installation and operation and maintenance of such Best Management Practices in order to assure compliance with the appropriate turbidity water quality standard.
 - a. The erosion and sediment control measures for the project must equal or exceed the proper design, installation, operation and maintenance outlined in the most recent version of the North Carolina Sediment and Erosion Control Planning and Design Manual. These devices shall be maintained on all construction sites, borrow sites, and waste pile (spoil) projects, including contractor-owned or leased borrow pits associated with the project.
 - b. For borrow pit sites, the erosion and sediment control measures must equal or exceed the proper design, installation, operation and maintenance outlined in the most recent version of the North Carolina Surface Mining Manual. The reclamation measures and implementation must comply with the reclamation in accordance with the requirements of the Sedimentation Pollution Control Act.
4. All sediment and erosion control measures shall not be placed in wetlands or waters to the maximum extent practicable. If placement of sediment and erosion control devices in wetlands and waters is unavoidable, they shall be removed and the natural grade restored after the Division of Land Resources has released the project.
5. If an environmental document is required, this Certification is not valid until a FONSI or ROD is issued by the State Clearinghouse. All water quality-related conditions of the FONSI or ROD shall become conditions of this Certification.

6. No live or fresh concrete shall come into contact with waters of the state until the concrete has hardened.
7. There shall be no excavation from or waste disposal into jurisdictional wetlands or waters associated with this permit without appropriate modification of this permit. Should waste or borrow sites be located in wetlands or stream, compensatory mitigation will be required since it is a direct impact from road construction activities.
8. Excavation of the stream crossings should be conducted in the dry. Sandbags, cofferdams, flexible pipe, or other diversion structures should be used to minimize excavation in flowing water.
9. All channel relocations will be constructed in a dry work area, and stabilized before stream flows are diverted. Channel relocations will be completed and stabilized prior to diverting water into the new channel. Whenever possible, channel relocations shall be allowed to stabilize for an entire growing season. Vegetation used for bank stabilization shall be limited to native woody species, and should include establishment of a 30 foot wide wooded and an adjacent 20 foot wide vegetated buffer on both sides of the relocated channel to the maximum extent practical. A transitional phase incorporating coir fiber and seedling establishment is allowable. Also, rip-rap may be allowed if it is necessary to maintain the physical integrity of the stream, but the applicant must provide written justification and any calculations used to determine the extent of rip-rap coverage requested.
10. Upon completion of the project, the NCDOT shall complete and return the enclosed "Certification of Completion Form" to notify DWQ when all work included in the 401 Certification has been completed. The responsible party shall complete the attached form and return it to the 401/Wetlands Unit of the Division of Water Quality upon completion of the project.
11. Placement of culverts and other structures in waters, streams, and wetlands must be placed below the elevation of the streambed to allow low flow passage of water and aquatic life unless it can be shown to DWQ that providing passage would be impractical. Design and placement of culverts and other structures including temporary erosion control measures shall not be conducted in a manner that may result in dis-equilibrium of wetlands or streambeds or banks, adjacent to or upstream and down stream of the above structures. The applicant is required to provide evidence that the equilibrium shall be maintained if requested in writing by DWQ.
12. During the construction of the project, no staging of equipment of any kind is permitted in waters of the U.S., or protected riparian buffers.
13. All temporary fills in wetlands and surface waters shall be removed upon completion of the project. In addition, the post-construction removal of any temporary bridge structures or fill will need to return the project site to its preconstruction contours and elevations. The revegetation of the impacted areas with appropriate native species will be required.
14. Riparian vegetation must be reestablished within the construction limits of the project by the end of the growing season following completion of construction.
15. Any riprap used must not interfere with thalweg performance and aquatic life passage during low flow conditions.

16. Heavy equipment should be operated from the bank rather than in the stream channel whenever possible in order to minimize sedimentation and reduce the likelihood of introducing other pollutants into the stream. All mechanized equipment operated near surface waters must be regularly inspected and maintained to prevent contamination of stream waters from fuels, lubricants, hydraulic fluids, or other toxic materials.
17. Discharging hydroseed mixtures and washing out hydroseeders and other equipment in or adjacent to surface waters is prohibited.
18. Two copies of the final construction drawings shall be furnished to NCDWQ prior to the pre-construction meeting. Written verification shall be provided that the final construction drawings comply with the attached permit drawings contained in the application dated May 11, 2004.
19. The outside buffer, wetland or water boundary located within the construction corridor approved by this authorization shall be clearly marked by orange fabric fencing prior to any land disturbing activities. Impacts to areas within the fencing are prohibited unless otherwise authorized by this certification.
20. NCDOT, and its authorized agents, shall conduct its activities in a manner consistent with State water quality standards (including any requirements resulting from compliance with §303(d) of the Clean Water Act) and any other appropriate requirements of State law and Federal law. If DWQ determines that such standards or laws are not being met (including the failure to sustain a designated or achieved use) or that State or federal law is being violated, or that further conditions are necessary to assure compliance, DWQ may reevaluate and modify this certification to include conditions appropriate to assure compliance with such standards and requirements in accordance with 15A NCAC 2H.0507(d). Before modifying the certification, DWQ shall notify NCDOT and the US Army Corps of Engineers, provide public notice in accordance with 15A NCAC 2H.0503 and provide opportunity for public hearing in accordance with 15A NCAC 2H.0504. Any new or revised conditions shall be provided to NCDOT in writing, shall be provided to the United States Army Corps of Engineers for reference in any permit issued pursuant to Section 404 of the Clean Water Act, and shall also become conditions of the 404 Permit for the project.
21. A copy of this Water Quality Certification shall be posted on the construction site at all times. In addition, the Water Quality Certification (and all subsequent modifications, if any, shall be maintained with the Division Engineer and the on-site project manager.
22. Culverts that are less than 48-inch in diameter should be buried to a depth equal to or greater than 20% of their size to allow for aquatic life passage. Culverts that are 48-inch in diameter or larger should be buried at least 12 inches below the stream bottom to allow natural stream bottom material to become established in the culvert following installation and to provide aquatic life passage during periods of low flow. These measurements must be based on natural thalweg depths.
23. All the authorized activities and conditions of certification associated with the original Water Quality Certification dated March 19, 2004 and all other corresponding modifications still apply except where superseded by this certification.

Violations of any condition herein set forth may result in revocation of this Certification and may result in criminal and/or civil penalties. This Certification shall become null and void unless the above conditions are made conditions of the Federal 404 and/or Coastal Area Management Act Permit. This Certification shall expire upon the expiration of the 404 or CAMA permit.

If this Certification is unacceptable to you have the right to an adjudicatory hearing upon written request within sixty (60) days following receipt of this Certification. This request must be in the form of a written petition conforming to Chapter 150B of the North Carolina General Statutes and filed with the Office of Administrative Hearings, P.O. Box 27447, Raleigh, N.C. 27611-7447. If modifications are made to an original Certification, you have the right to an adjudicatory hearing on the modifications upon written request within sixty (60) days following receipt of the Certification. Unless such demands are made, this Certification shall be final and binding.

This the 22nd day of November 2004

DIVISION OF WATER QUALITY

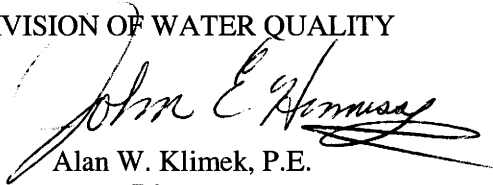
A handwritten signature in black ink, appearing to read "Alan W. Klimek", with a stylized flourish at the end.

Alan W. Klimek, P.E.
Director

WQC No. 3455

DWQ Project No.: _____ County: _____

Applicant: _____

Project Name: _____

Date of Issuance of 401 Water Quality Certification: _____

Certificate of Completion

Upon completion of all work approved within the 401 Water Quality Certification or applicable Buffer Rules, and any subsequent modifications, the applicant is required to return this certificate to the 401/Wetlands Unit, North Carolina Division of Water Quality, 1621 Mail Service Center, Raleigh, NC, 27699-1621. This form may be returned to DWQ by the applicant, the applicant's authorized agent, or the project engineer. It is not necessary to send certificates from all of these.

Applicant's Certification

I, _____, hereby state that, to the best of my abilities, due care and diligence was used in the observation of the construction such that the construction was observed to be built within substantial compliance and intent of the 401 Water Quality Certification and Buffer Rules, the approved plans and specifications, and other supporting materials.

Signature: _____ Date: _____

Agent's Certification

I, _____, hereby state that, to the best of my abilities, due care and diligence was used in the observation of the construction such that the construction was observed to be built within substantial compliance and intent of the 401 Water Quality Certification and Buffer Rules, the approved plans and specifications, and other supporting materials.

Signature: _____ Date: _____

Engineer's Certification

_____ Partial _____ Final

I, _____, as a duly registered Professional Engineer in the State of North Carolina, having been authorized to observe (periodically, weekly, full time) the construction of the project, for the Permittee hereby state that, to the best of my abilities, due care and diligence was used in the observation of the construction such that the construction was observed to be built within substantial compliance and intent of the 401 Water Quality Certification and Buffer Rules, the approved plans and specifications, and other supporting materials.

Signature _____

Registration No. _____

Date _____



REPLY TO
ATTENTION OF:

DEPARTMENT OF THE ARMY
WILMINGTON DISTRICT, CORPS OF ENGINEERS
P.O. BOX 1890
WILMINGTON, NORTH CAROLINA 28402-1890

December 16, 2004

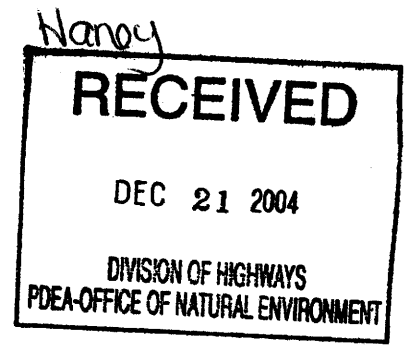

Regulatory Division

Subject: Action ID. 199821203; TIP No. I-2304A

Dr. Gregory J. Thorpe, Ph.D.
Environmental Management Director, PDEA
N.C. Department of Transportation
1548 Mail Service Center
Raleigh, NC 27699-1548

Dear Mr. Thorpe:

In accordance with the written request of February 20, 2004, and the ensuing administrative record, enclosed is a permit to authorize the discharge of fill material into waters of the United States, for construction of Section A of the Interstate 85 (I-85) Improvements (T.I.P. No. I-2304A), from north of SR 2120 (Exit 81), northeast of Spencer, in Rowan County, to north of I-85 Business (Exit 87), southwest of Lexington, in Davidson County, North Carolina, crossing the Yadkin River, Potts Creek, and unnamed tributaries.

If any change in the authorized work is required because of unforeseen or altered conditions or for any other reason, the plans revised to show the change must be sent promptly to this office. Such action is necessary, as revised plans must be reviewed and the permit modified.

Carefully read your permit. The general and special conditions are important. Your failure to comply with these conditions could result in a violation of Federal law. Certain significant general conditions require that:

- a. You must complete construction before December 31, 2009.
- b. You must notify this office in advance as to when you intend to commence and complete work.
- c. You must allow representatives from this office to make periodic visits to your worksite as deemed necessary to assure compliance with permit plans and conditions.

Should you have questions, contact Mr. Eric Alsmeyer of my Raleigh Field Office regulatory staff at telephone (919) 876-8441, extension 23.

Sincerely,

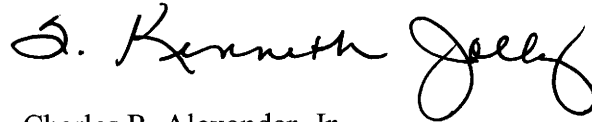

for Charles R. Alexander, Jr.
Colonel, U.S. Army
District Engineer

Enclosures

Copy Furnished with enclosures:

Chief, Source Data Unit
NOAA/National Ocean Service
ATTN: Sharon Tear N/CS261
1315 East-West Hwy., Rm 7316
Silver Spring, MD 20910-3282

Copies Furnished with special conditions and plans:

Mr. Pete Benjamin, Field Supervisor
U.S. Fish and Wildlife Service
Fish and Wildlife Enhancement
Post Office Box 33726
Raleigh, North Carolina 27636-3726

Mr. Ron Sechler
National Marine Fisheries
Service, NOAA
Pivers Island
Beaufort, North Carolina 28516

Mr. David Rackley
National Marine Fisheries
Service, NOAA
219 Fort Johnson Road
Charleston, South Carolina 29412-9110

•
* Mr. Ronald Mikulak, Chief
Wetlands Section - Region IV
Water Management Division
U.S. Environmental Protection Agency
Atlanta Federal Center
61 Forsyth Street, SW
Atlanta, Georgia 30303

Mr. Doug Huggett
NC Division of Coastal Management
Division of Coastal Management
151-B, NC Hwy 24
Morehead City, NC 2855

Mr. William D. Gilmore, P.E.
EEP Transition Manager
Ecosystem Enhancement Center
1652 Mail Service Center
Raleigh, NC 27699-1652

DEPARTMENT OF THE ARMY PERMIT

RECEIVED

NC Department of Transportation

DEC 14 2004

Permittee _____

199821203

Permit No. _____

USAED, Wilmington

Issuing Office _____

REGULATORY
WLM, FLD, CFC.

NOTE: The term "you" and its derivatives, as used in this permit, means the permittee or any future transferee. The term "this office" refers to the appropriate district or division office of the Corps of Engineers having jurisdiction over the permitted activity or the appropriate official of that office acting under the authority of the commanding officer.

You are authorized to perform work in accordance with the terms and conditions specified below.

Project Description:

Place fill material impacting a total of 2.29 acres of wetlands and 4,455 linear feet of stream, for construction of Section A of the Interstate 85 (I-85) Improvements (T.I.P. No. I-2304A), crossing the Yadkin River, Potts Creek, and unnamed tributaries.

Project Location:

From north of SR 2120 (Exit 81), northeast of Spencer, in Rowan County, to north of I-85 Business (Exit 87), southwest of Lexington, in Davidson County, North Carolina.

Permit Conditions:

General Conditions:

1. The time limit for completing the work authorized ends on December 31, 2009. If you find that you need more time to complete the authorized activity, submit your request for a time extension to this office for consideration at least one month before the above date is reached.
2. You must maintain the activity authorized by this permit in good condition and in conformance with the terms and conditions of this permit. You are not relieved of this requirement if you abandon the permitted activity, although you may make a good faith transfer to a third party in compliance with General Condition 4 below. Should you wish to cease to maintain the authorized activity or should you desire to abandon it without a good faith transfer, you must obtain a modification of this permit from this office, which may require restoration of the area.
3. If you discover any previously unknown historic or archeological remains while accomplishing the activity authorized by this permit, you must immediately notify this office of what you have found. We will initiate the Federal and state coordination required to determine if the remains warrant a recovery effort or if the site is eligible for listing in the National Register of Historic Places.

4. If you sell the property associated with this permit, you must obtain the signature of the new owner in the space provided and forward a copy of the permit to this office to validate the transfer of this authorization.
5. If a conditioned water quality certification has been issued for your project, you must comply with the conditions specified in the certification as special conditions to this permit. For your convenience, a copy of the certification is attached if it contains such conditions.
6. You must allow representatives from this office to inspect the authorized activity at any time deemed necessary to ensure that it is being or has been accomplished in accordance with the terms and conditions of your permit.

Special Conditions:

See enclosed sheet.

Further Information:

1. **Congressional Authorities:** You have been authorized to undertake the activity described above pursuant to:
 - () Section 10 of the Rivers and Harbors Act of 1899 (33 U.S.C. 403).
 - (X) Section 404 of the Clean Water Act (33 U.S.C. 1344).
 - () Section 103 of the Marine Protection, Research and Sanctuaries Act of 1972 (33 U.S.C. 1413).
2. **Limits of this authorization.**
 - a. This permit does not obviate the need to obtain other Federal, state, or local authorizations required by law.
 - b. This permit does not grant any property rights or exclusive privileges.
 - c. This permit does not authorize any injury to the property or rights of others.
 - d. This permit does not authorize interference with any existing or proposed Federal project.
3. **Limits of Federal Liability.** In issuing this permit, the Federal Government does not assume any liability for the following:
 - a. Damages to the permitted project or uses thereof as a result of other permitted or unpermitted activities or from natural causes.
 - b. Damages to the permitted project or uses thereof as a result of current or future activities undertaken by or on behalf of the United States in the public interest.
 - c. Damages to persons, property, or to other permitted or unpermitted activities or structures caused by the activity authorized by this permit.
 - d. Design or construction deficiencies associated with the permitted work.



1998 21 203
COPY
RECEIVED

Michael F. Easley, Governor
William G. Ross Jr., Secretary
North Carolina Department of Environment and Natural Resources

Alan W. Klimek, P.E., Director
Division of Water Quality
Coleen H. Sullins, Deputy Director
Division of Water Quality

APR 9 1 2004

March 19, 2004

RALEIGH REGULATORY FIELD OFFICE

Mr. Gregory J. Thorpe, Ph.D., Environmental Director
NCDOT Planning and Environmental Branch
1548 Mail Service Center
Raleigh, NC, 27699-1548

Dear Dr. Thorpe:

Re: Water Quality Certification Pursuant to §401 of the Federal Clean Water Act.
Improvements to I-85 from north of SR 2120 in Rowan County to north of I-85 Business in Davidson County.
F.A. Project No. NHF-85-3(164)80; State Project No. 8.1631403
TIP No. I-2304AA and I-2304AB
DWQ Project No. 040275

Attached hereto is a copy of Certification No. 3455 issued to The North Carolina Department of Transportation dated March 19, 2004.

If we can be of further assistance, do not hesitate to contact us.

Sincerely,

Alan W. Klimek, P.E.

Attachments

cc: Wilmington District Corps of Engineers
Eric Alsmeyer, USACE Raleigh Field Office
NCDWQ Winston-Salem Regional Office
Christopher Militscher, US Environmental Protection Agency – Region IV
William Gilmore, NC Ecological Enhancement Program
Central Files
File Copy





NORTH CAROLINA 401 WATER QUALITY CERTIFICATION

THIS CERTIFICATION is issued in conformity with the requirements of Section 401 Public Laws 92-500 and 95-217 of the United States and subject to the North Carolina Division of Water Quality (DWQ) Regulations in 15 NCAC 2H, .0500. This Certification authorizes the NCDOT to incur the following permanent impacts:

I-2304 Section AA

- 0.02 acres of riverine wetlands through excavation and mechanized clearing;
- 1.08 acres of non-riverine wetlands through fill and mechanized clearing;
- 2644 linear feet of jurisdictional stream loss.

I-2304 Section AB

- 1.03 acres of riverine wetlands through fill, excavation, and mechanized clearing.
- 0.16 acres of non-riverine wetlands through fill and mechanized clearing.
- 1811 linear feet of jurisdictional stream loss;
- 0.003 acres of ponds (filling or draining).

The I-2304AA and I-2304AB projects shall be constructed pursuant to the application dated February 20, 2004 to improve I-85 from north of SR 2120 in Rowan County to north of I-85 Business in Davidson County.

The Application provides adequate assurance that the discharge of fill material into the waters of the state with the proposed development will not result in a violation of applicable Water Quality Standards and discharge guidelines. Therefore, the State of North Carolina certifies that this activity will not violate the applicable portions of Sections 301, 302, 303, 306, 307 of PL 92-500 and PL 95-217 if conducted in accordance with the application and conditions hereinafter set forth.

This approval is only valid for the purpose and design that you submitted in your Application. All work authorized by this Certification must be done in strict compliance with the plans attached to the Application. If this project changes, incurring additional impacts to streams, wetlands or buffers, you are required to notify the DWQ *in writing*, and you may be required to submit a new application. Additional compensatory mitigation may be required as described in 15A NCAC 2H .0506 (h) (6) and (7). For this approval to remain valid, you are required to comply with all the conditions listed below. In addition, you should obtain all other federal, state or local permits before proceeding with your project including (but not limited to) Sediment and Erosion Control, Non-discharge and Water Supply watershed regulations.

This Certification shall expire three (3) years from the date of the cover letter from DWQ or on the same day as the expiration date of the corresponding US Army Corps of Engineers Permit, whichever is later.

Condition(s) of Certification:

1. Erosion and sediment control practices must be in full compliance with all specifications governing the proper design, installation and operation and maintenance of such Best Management Practices in order to protect surface waters standards:
 - a. The erosion and sediment control measures for the project must be designed, installed, operated, and maintained in accordance with the most recent version of the *North Carolina Sediment and Erosion Control Planning and Design Manual*.
 - b. The design, installation, operation, and maintenance of the sediment and erosion control measures must be such that they equal, or exceed, the requirements specified in the most recent version of the *North Carolina Sediment and Erosion Control Manual*. The devices shall be maintained on all construction sites, borrow sites, and waste pile (spoil) projects, including contractor-owned or leased borrow pits associated with the project.
 - c. For borrow pit sites, the erosion and sediment control measures must be designed, installed, operated, and maintained in accordance with the most recent version of the *North Carolina Surface Mining Manual*.
 - d. Any reclamation measures and implementation must comply with the reclamation in accordance with the requirements of the Sedimentation Pollution Control Act.
2. No waste, spoil, solids, or fill of any kind shall occur in wetlands, waters, or riparian areas beyond the footprint of the impacts depicted in the Application. All construction activities shall be performed so that no violations of state water quality standards, statutes, or rules occur.
3. Sediment and erosion control measures shall not be placed in wetlands or waters to the maximum extent practicable. If placement of sediment and erosion control devices in wetlands and waters is unavoidable, they shall be removed and the natural grade restored within 30 days after the project has been released.
4. Stormwater management shall be constructed in accordance with the hydraulic design plans submitted in the February 20, 2004 application.
5. The hazardous spill catch basins (I-2304AA Plan Sheet 9) shall be designed and located to afford ready access to maintenance and emergency response personnel and equipment.
 - The volume of spill containment storage provided will be approximately 10,000 gallons plus the estimated runoff volume from rainfall intensity equating to a two-year return period event.
 - A means will be provided such that the normal free flow of runoff at the basin outlet can be interrupted to cause containment of hazardous runoff. This can be accomplished by providing a mechanical control gate or by constructing a minimum control section in the outlet channel. The mechanical gate alternative will generally be utilized in areas where normal operational activities would allow close scrutiny and control, reducing the potential for problems with vandalism.
 - Maintenance plans for constructed basins shall be developed in accordance with Best Management Practices (BMPs) and good engineering practices. Additional guidance for properly maintaining containment basins can be found at 40 CFR Part 112, §112.7, *et al.* (Spill Prevention Control and Countermeasures).
 - Inspections of the hazardous spill catch basin and opening/shutting of the gate should be performed annually at a minimum, and within six (6) months after a spill incident to ensure integrity of the catch basin.
 - Repairs should occur in a timely manner.

- NCDOT should provide annually, a site location map of all hazardous spill catch basins and similar devices to Federal (USEPA, USCG), DENR, State Emergency Response Coordinator, and all applicable county and urban center response groups.
 - Signage indicating the presence of a hazardous spill catch basin shall be provided.
6. The outside wetland or water boundary as well as along the construction corridor within these boundaries approved under this authorization shall be clearly marked by orange fabric fencing for the areas that have been approved to infringe within the wetland or water prior to any land disturbing activities.
 7. NCDOT and its contractors and/or agents shall not excavate, fill, or perform mechanized land clearing at any time in the construction or maintenance of this project within waters and/or wetlands, except as authorized by this Certification, or any modification to this Certification. There shall be no excavation from or waste disposal into jurisdictional wetlands or waters associated with this Certification without appropriate modification. If this occurs, compensatory mitigation will be required since it is a direct impact from road construction activities.
 8. Excavation of stream crossings should be conducted in the dry unless demonstrated by the applicant or its authorized agent to be unfeasible. Sandbags, cofferdams, flexible pipe, or other diversion structures should be used to minimize excavation in flowing water.
 9. Live or fresh concrete shall not come into contact with waters of the state until the concrete has hardened.
 10. Discharging hydroseeding mixtures and washing out hydroseeders and other equipment in or adjacent to surface waters is strictly prohibited.
 11. The removal of vegetation in riparian areas should be minimized. NCDOT is encouraged to use existing on-site vegetation and materials for stream bank stabilization and to minimize the use of rip rap. Riprap shall not be placed in the stream bottom. Riparian vegetation, using native trees and shrubs, must be re-established within the construction limits of the project by the end of the growing season following completion of construction to reestablish the riparian zone and to provide long-term erosion control.
 12. Culverts that are less than 48-inch in diameter should be buried to a depth equal to or greater than 20% of their size to allow for aquatic life passage. Culverts that are 48-inch diameter or larger should be buried at least 12 inches below the stream bottom to allow natural stream bottom material to become established in the culvert following installation and to provide aquatic life passage during periods of low flow. If any of the existing pipes are perched, they shall be removed and replaced, and re-installed correctly, unless demonstrated that this is topographically unfeasible.
 13. Heavy equipment should be operated from the bank rather than in the stream channel unless demonstrated by the applicant or its authorized agent to be unfeasible. All mechanized equipment operated near surface waters should be inspected and maintained regularly to prevent contamination of stream waters from fuels, lubricants, hydraulic fluids or other toxic substances.
 14. *Summary of Compensatory Mitigation:* Compensatory mitigation shall be the same as that approved by the US Army Corps of Engineers, as long as the mitigation required equals a ratio of 1:1 restoration or creation of lost wetland acres as described in 15A NCAC 2H.0506 (h)(6), and consists of the following:

I-2304 Section AA

- 0.02 acres of on-site riverine wetland restoration within I-2304 Section AA
- 2644 linear feet of stream impacts will be mitigated through NCDENR Ecosystem Enhancement Program (EEP).
- 1.08 acres of impacts to non-riverine wetlands will be mitigated through EEP.

I-2304 Section AB

- 1.03 acres of on-site riverine wetland restoration within I-2304 Section AA.
- 1811 linear feet of stream will be mitigated through EEP.
- 0.16 acres of impacts to non-riverine wetlands will be mitigated through EEP.

In accordance with 15A NCAC 2R.0500, this contribution will satisfy NC Division of Water Quality's compensatory mitigation requirements under 15A NCAC 2H.0506(h). Until the EEP receives and clears your payments, wetland or stream fill shall not occur. The payments to EEP shall be sent within two (2) months of issuance of the 404 permit.

15. Rock check dams at culvert outlets should be removed at project completion to avoid blocking movement of aquatic life.
16. Two copies of the final construction drawings shall be furnished to NCDWQ prior to the pre-construction meeting. Written verification shall be provided that the final construction drawings comply with the attached permit drawings contained in the Application dated February 20, 2004.
17. Upon completion of the project, the NCDOT shall complete and return the enclosed "Certification of Completion Form" to notify DWQ when all work included in the 401 Certification has been completed. The responsible party shall complete the attached form and return it to the 401/Wetlands Unit of the Division of Water Quality upon completion of the project.
18. NCDOT and its authorized agents shall conduct its activities in a manner consistent with State water quality standards and any other appropriate requirements of State law and Federal law. If DWQ determines that such standards or laws are not being met (including the failure to sustain a designated or achieved use) or that State or federal law is being violated, or that further conditions are necessary to assure compliance, DWQ may reevaluate and modify this Certification to include conditions appropriate to assure compliance with such standards and requirements in accordance with 15A NCAC 2H.0507(d). Before modifying the Certification, DWQ shall notify NCDOT and the US Army Corps of Engineers, provide public notice in accordance with 15A NCAC 2H.0503 and provide opportunity for public hearing in accordance with 15A NCAC 2H.0504. Any new or revised conditions shall be provided to NCDOT in writing, shall be provided to the United States Army Corps of Engineers for reference in any permit issued pursuant to Section 404 of the Clean Water Act, and shall also become conditions of the 404 Permit for the project.

NCDOT shall require its contractors (and/or agents) to comply with all of the terms of this Certification, and shall provide each of its contractors (and/or agents) a copy of this Certification.

Violations of any condition herein set forth may result in revocation of this Certification and may result in criminal and/or civil penalties. This Certification shall become null and void unless the above conditions are made conditions of the Federal Permit. This Certification shall expire upon the expiration of the 404 Permit.

Gregory J. Thorpe, Ph.D.
§401 Water Quality Certification No. 3455
I-2304 AA and I-2304 BA

If you do not accept any of the conditions of this certification, you may ask for an adjudicatory hearing. You must act within 60 days of the date that you receive this letter. To ask for a hearing, send a written petition that conforms to Chapter 150B of the North Carolina General Statutes to the Office of Administrative Hearings, 6714 Mail Service Center, Raleigh, N.C. 27699-6714. This certification and its conditions are final and binding unless you ask for a hearing.

This the 19th day of March 2004

DIVISION OF WATER QUALITY

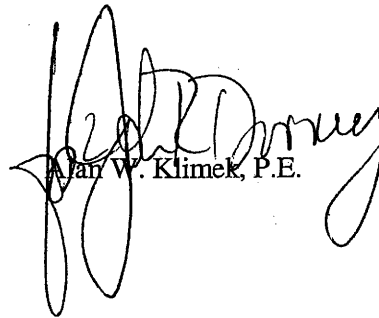

Alan W. Klimek, P.E.

WQC No. 3455

**NORTH CAROLINA – DIVISION OF WATER QUALITY
401 WATER QUALITY CERTIFICATION
SUMMARY OF PERMITTED IMPACTS AND MITIGATION REQUIREMENTS**

In accordance with 15A NCAC 2H.0500, NCDOT, DWQ Project No. 040275, is authorized to impact the surface waters of the State of North Carolina as indicated below for the purpose of improving I-85 from north of SR 2120 in Rowan County to north of I-85 Business in Davidson County. All activities associated with these authorized impacts must be conducted in accordance with the conditions listed in the attached Certification transmittal letter. **THIS CERTIFICATION IS NOT VALID WITHOUT THE ATTACHMENTS.**

Summary of Impacts

I-2304 Section AA

- 0.02 acres of riverine wetlands through excavation and mechanized clearing;
- 1.08 acres of non-riverine wetlands through fill and mechanized clearing;
- 2644 linear feet of jurisdictional stream loss.

I-2304 Section AB

- 1.03 acres of riverine wetlands through fill, excavation, and mechanized clearing.
- 0.16 acres of non-riverine wetlands through fill and mechanized clearing.
- 1811 linear feet of jurisdictional stream loss;
- 0.003 acres of ponds (filling or draining).

On-site mitigation to be performed by NCDOT:

- 0.02 acres of on-site riverine wetland restoration within I-2304 Section AA.
- 1.03 acres of on-site riverine wetland restoration within I-2304 Section AA.

COMPENSATORY MITIGATION REQUIREMENTS:

LOCATION: I-85
COUNTY: Davidson and Rowan Counties
BASIN/SUBBASIN: Yadkin-Pee Dee, Hydrologic Unit 03040103

As required by 15A NCAC 2B .0250 and 15A NCAC 2H .0506(h), and the conditions of this Certification, you are required to compensate for the above impacts through the restoration, creation, enhancement or preservation of wetlands, buffers, and surface waters as outlined below *prior* to conducting any activities that impact or degrade waters of the state. Mitigation to be performed by NC Ecological Enhancement Program in Hydrologic Unit 03040103:

- 4455 linear feet of stream impacts.
- 1.24 acres of impacts to non-riverine wetlands.

One of the options you have available to satisfy the compensatory mitigation requirements is through payment of a fee to the Ecosystem Enhancement Program per 15A NCAC 2R .0503. If you choose this option, please sign this form and mail it to the address listed below. An invoice for the appropriate amount of payment will be sent to you upon receipt of this form. **PLEASE NOTE, THE ABOVE IMPACTS ARE NOT AUTHORIZED UNTIL YOU RECEIVE NOTIFICATION THAT YOUR PAYMENT HAS BEEN PROCESSED BY THE ECOSYSTEM ENHANCEMENT PROGRAM.**

Signature

Date

ECOSYSTEM ENHANCEMENT PROGRAM
1652 Mail Service Center
RALEIGH, NC, 27699-1652

SPECIAL CONDITIONS (Action ID. 199821203; NCDOT/TIP I-2304A)

COMPLIANCE WITH PLANS

a) All work must be performed in strict compliance with the attached plans, which are a part of this permit. Any modification to the permit plans must be approved by the US Army Corps of Engineers (USACE) prior to implementation.

ACTIVITIES NOT AUTHORIZED

b) Except as authorized by this permit or any USACE approved modification to this permit, no excavation, fill, or mechanized land-clearing activities shall take place at any time in the construction or maintenance of this project, within waters or wetlands, nor shall any activities take place that cause the degradation of waters or wetlands. In addition, except as specified in the plans attached to this permit, no excavation, fill or mechanized land-clearing activities shall take place at any time in the construction or maintenance of this project, in such a manner as to impair normal flows and circulation patterns within, into, or out of waters or wetlands or to reduce the reach of waters or wetlands.

This permit does not authorize temporary placement or double handling of excavated or fill material within jurisdictional waters, including wetlands, outside the permitted area. Additionally, no construction materials or equipment will be placed or stored within jurisdictional waters, including wetlands.

CONSTRUCTION PLANS

c) The permittee will ensure that the construction design plans for this project do not deviate from the permit plans attached to this authorization. Written verification shall be provided that the final construction drawings comply with the attached permit drawings prior to any active construction in waters of the United States, including wetlands. Any deviation in the construction design plans will be brought to the attention of the Corps of Engineers, Raleigh Regulatory Field Office prior to any active construction in waters or wetlands.

d) Prior to commencing construction within jurisdictional waters of the United States for any portion of the proposed project, the permittee shall forward the latest version of project construction drawings to the Corps of Engineers, Raleigh Regulatory Field Office NCDOT Regulatory Project Manager. Half-size drawings will be acceptable.

POLLUTION SPILLS

e) All mechanized equipment will be regularly inspected and maintained to prevent contamination of waters and wetlands from fuels, lubricants, hydraulic fluids, or other

toxic materials. No equipment staging or storage of construction material will occur in wetlands. Hydro-seeding equipment will not be discharged or washed out into any surface waters or wetlands. In the event of a spill of petroleum products or any other hazardous waste, the permittee shall immediately report it to the N.C. Division of Water Quality at (919) 733-5083 or (800) 662-7956 and provisions of the North Carolina Oil Pollution and Hazardous Substances Control Act will be followed.

CLEAN FILL MATERIAL

f) Unless otherwise authorized by this permit, all fill material placed in waters or wetlands shall be generated from an upland source and will be clean and free of any pollutants except in trace quantities. Metal products, organic materials (including debris from land clearing activities), or unsightly debris will not be used.

CONTRACTOR COMPLIANCE

g) The permittee shall require its contractors and/or agents to comply with the terms and conditions of this permit in the construction and maintenance of this project, and shall provide each of its contractors and/or agents associated with the construction or maintenance of this project with a copy of this permit, and any authorized modifications. A copy of this permit, and any authorized modifications, including all conditions, shall be available at the project site during construction and maintenance of this project.

SEDIMENTATION AND EROSION CONTROL MEASURES

h) The permittee shall use appropriate sediment and erosion control practices which equal or exceed those outlined in the most recent version of the "North Carolina Sediment and Erosion Control Planning and Design Manual" to assure compliance with the appropriate turbidity water quality standard. . Erosion and sediment control practices must be in full compliance with all specifications governing the proper design, installation and operation and maintenance of such Best Management Practices in order to assure compliance with the appropriate turbidity water quality standards. Additionally, the project must remain in full compliance with all aspects of the Sedimentation Pollution Control Act of 1973 (North Carolina General Statutes Chapter 113A Article 4).

Adequate sedimentation and erosion control measures must be implemented prior to any ground disturbing activities to minimize impacts to downstream aquatic resources. These measures must be inspected and maintained regularly, especially following rainfall events. All fill material must be adequately stabilized at the earliest practicable date to prevent sediment from entering into adjacent waters or wetlands.

The permittee shall remove all sediment and erosion control measures placed in wetlands or waters, and shall restore natural grades in those areas, prior to project completion.

During the clearing phase of the project, heavy equipment must not be operated in surface waters or stream channels. Temporary stream crossings will be used to access the opposite sides of stream channels. All temporary diversion channels and stream crossings will be constructed of nonerodable materials. Grubbing of riparian vegetation will not occur until immediately before construction begins on a given segment of stream channel.

REPORTING OF VIOLATIONS

i) The permittee will report any violation of these conditions or violations of Section 404 of the Clean Water Act or Section 10 of the Rivers and Harbors Act in writing to the Wilmington District, U. S Army Corps of Engineers, within 24 hours of the permittee's discovery of the violation.

COMPLIANCE WITH SPECIAL CONDITIONS

j) Failure to institute and carry out the details of the following special conditions, below, will result in a directive to cease all ongoing and permitted work within waters and/or wetlands associated with the permitted project, or such other remedies and/or fines as the District Engineer or his authorized representatives may seek.

WET CONCRETE

k) The permittee shall take measures to prevent live or fresh concrete from coming into contact with any surface waters until the concrete has hardened.

CULVERTS

l) All authorized culverts will be installed to allow the passage of low stream flows and the continued movement of fish and other aquatic life as well as to prevent headcutting of the streambed. For all box culverts and for pipes greater than 48 inches in diameter, the bottom of the pipe will be buried at least one foot below the bed of the stream unless burial would be impractical and the Corps of Engineers has waived this requirement. For culverts 48 inches in diameter or smaller, the bottom of the pipe must be buried below the bed of the stream to a depth equal to or greater than 20 percent of the diameter of the culvert. Design and placement of culverts and other structures including temporary erosion control measures shall not be conducted in a manner that may result in disequilibrium of wetlands or streambeds or banks, adjacent to, upstream or downstream of the structures. In order to allow for the continued movement of bed load and aquatic organisms, existing stream channel widths and depths will be maintained at the inlet and outlet ends of culverts. Riprap armoring of streams at culvert inlets and outlets shall be minimized above the ordinary high water elevation in favor of bioengineering techniques such as bank sloping, erosion control matting and revegetation with deep-rooted, woody plants.

PRECONSTRUCTION MEETING

m) The permittee shall schedule a preconstruction meeting between its representatives, the contractor's representatives, and the Corps of Engineers, Raleigh Regulatory Field Office, NCDOT Regulatory Project Manager, prior to any work within jurisdictional waters and wetlands to ensure that there is a mutual understanding of all of the terms and conditions contained within this Department of the Army Permit. The permittee shall provide the USACE, Raleigh Regulatory Field Office, NCDOT Regulatory Project Manager, with a copy of the final plans at least two weeks prior to the preconstruction meeting along with a description of any changes that have been made to the project's design, construction methodology or construction timeframe. The permittee shall schedule the preconstruction meeting for a time when the USACE and North Carolina Division of Water Quality (NCDWQ) Project Managers can attend. The permittee shall invite the Corps and NCDWQ Project Managers a minimum of thirty (30) days in advance of the scheduled meeting in order to provide those individuals with ample opportunity to schedule and participate in the required meeting.

BORROW AND WASTE

n) To ensure that all borrow and waste activities occur on high ground and do not result in the degradation of adjacent wetlands and streams, except as authorized by this permit, the permittee shall require its contractors and/or agents to identify all areas to be used to borrow material, or to dispose of dredged, fill, or waste material. The permittee shall provide the USACE with appropriate maps indicating the locations of proposed borrow or waste sites as soon as the permittee has that information. The permittee will coordinate with the USACE before approving any borrow or waste sites that are within 400 feet of any streams or wetlands. All jurisdictional wetland lines on borrow and waste sites shall be verified by the Corps of Engineers and shown on the approved reclamation plans. The permittee shall ensure that all such areas comply with Condition b) of this permit, and shall require and maintain documentation of the location and characteristics of all borrow and disposal sites associated with this project. This information will include data regarding soils, vegetation and hydrology sufficient to clearly demonstrate compliance with the Condition b). All information will be available to the USACE upon request. NCDOT shall require its contractors to complete and execute reclamation plans for each waste and borrow site and provide written documentation that the reclamation plans have been implemented and all work is completed. This documentation will be provided to the Corps of Engineers within 30 days of the completion of the reclamation work.

MITIGATION

o. The permittee shall mitigate for 2.29 acres of wetland impacts, and 4,455 linear feet of impact to streams with important aquatic function, for this project, as described below (1.05 acres of riverine bottomland hardwood wetland restoration at the Yadkin River Swamp Hardwoods Restoration Mitigation Site, and 2.48 acres of restoration equivalent

non-riverine wetlands, and 8,910 linear feet of restoration equivalent warm water stream channel, through the North Carolina Ecosystem Enhancement Program (EEP), in the Yadkin River basin (Cataloging Unit 03040103).

YADKIN RIVER SWAMP HARDWOODS RESTORATION MITIGATION SITE

p. The permittee shall implement the compensatory wetland mitigation plan entitled "Restoration Plan for Swamp Hardwoods Wetlands At Existing Bridge Causeway of the I-85 Yadkin River In Rowan County", dated July 12, 2004, to provide the restoration described in condition n. below. NCDOT shall complete grading for the mitigation within one year of demolition of the existing I-85 Yadkin River bridge, and complete planting of the site within the first planting season (November 15 to March 15) after grading is completed. NCDOT shall contact the Corps of Engineers, Raleigh Regulatory Field Office NCDOT Regulatory Project Manager, a minimum of sixty days before completion of grading at the mitigation site, and inform the Project Manager of the expected completion date of the grading.

q. The permittee shall mitigate for 1.05 acres of unavoidable impacts to riverine bottomland hardwood forest wetlands associated with this project with 1.05 acres of riverine bottomland hardwood forest wetland restoration, at the Yadkin River Swamp Hardwoods Restoration Mitigation Site (Yadkin Site).

r. NCDOT will do a boundary survey of the 1.05 acres of wetland restoration at the Yadkin Site, and submit a copy of the survey to the District Engineer within 90 days after construction of the site is completed.

s. The permittee will monitor the site vegetation between June 1 and November 30, inclusively, of each year, and document plant mortality and stress. A minimum of one 0.05-acre sample plots will be established within the 1.05 acre restoration area, and will be placed randomly within a representative position. The permittee will continue monitoring of the planting area annually until the specified performance criteria is met, as described below.

YADKIN SITE MITIGATION MONITORING

t. Performance criteria for tree planting areas will be met if sample plots demonstrate that for each of the first three complete years of monitoring, 320 target-species trees per acre have survived, such that at the end of three years, 320 three-year old target-species trees per acre have survived on the site, and, in years four and five, 288 and 260 trees per acre, respectively, have survived on the site, such that at the end of year five, 260 five-year old target-species trees per acre have survived on the site.

u. If for any monitoring year, vegetation survival is not favorable, as determined by the Corps of Engineers, any remedial action required by the Corps of Engineers will be performed, the required restoration areas will be replanted, and the five-year monitoring period will begin again with year one.

GENERAL WETLANDS MITIGATION

v. The permittee and subsequent property owners shall maintain the Yadkin Site in its natural condition, as altered by work in the mitigation plan, in perpetuity. Prohibited activities within the mitigation site specifically include, but are not limited to: the construction or placement of roads, walkways, buildings, signs, or structures of any kind (i.e., billboards, interior fences, etc.); filling, grading, excavation, leveling, or any other earth moving activity or activity that may alter the drainage patterns on the property; the cutting, mowing, destruction, removal, or other damage of any vegetation; disposal or storage of any debris, trash, garbage, or other waste material; except as may be authorized by the mitigation plans, or subsequent modifications that are approved by the Corps of Engineers. In addition, the permittee shall take no action, whether on or off the mitigation property, which will adversely impact the wetlands on the mitigation property, except as specifically authorized by this permit, or subsequent modifications that are approved by the Corps of Engineers.

w. The permittee shall make every effort to convey the Yadkin Site property to a nonprofit conservation organization or a natural resource agency, which is willing to hold the areas in perpetuity for conservation purposes, and which is acceptable to the Corps of Engineers. The annual monitoring reports, as required, will include the status of the conveyance efforts.

x. The permittee shall not sell or otherwise convey any interest in the property used to satisfy mitigation requirements for this permit, to any third party, without 10 days prior notification to Wilmington District Corps of Engineers in writing, which writing shall reference this permit Action ID number.

y. Any sale, lease, or other conveyance of the mitigation site property shall include restrictions on the use of the property as described in condition x. above, which conditions shall be enforced by the North Carolina Department of Transportation. Such restrictions shall include language providing for third party enforcement rights in favor of the Corps of Engineers. Such restrictions must be approved prior to conveyance by the Corps of Engineers.

GENERAL MITIGATION

z. The permittee shall contact the Corps of Engineers, Raleigh Regulatory Field Office NCDOT Regulatory Project Manager, to provide that individual with the opportunity to attend the yearly mitigation monitoring efforts.

NC-EEP STREAM AND WETLAND MITIGATION:

aa. Compensatory mitigation for the unavoidable impacts to 1.24 acres of non-riverine wetlands, and 4,455 linear feet of stream associated with the proposed project shall be provided by the Ecosystem Enhancement Program (EEP), as outlined in the letter dated April 30, 2004 from William D. Gilmore, EEP Transition Manager. Pursuant to the EEP

Memorandum of Agreement (MOA) between the State of North Carolina and the US Army Corps of Engineers signed on July 22, 2003, the EEP will provide 2.48 acres of restoration equivalent non-riverine wetlands, and 8,910 linear feet of restoration equivalent warm water stream channel in the Yadkin River basin (Cataloging Unit 03040103) by one year of the date of this permit. For wetlands, a minimum of 1:1 (impact to mitigation) must be in the form of wetland restoration. The NCDOT shall, within 30 days of the issue date of this permit, certify that sufficient funds have been provided to EEP to complete the required mitigation, pursuant to Paragraph V. of the MOA.

Navigation

bb. The authorized fill and structures, and associated activities, in the Yadkin River must not interfere with the public's right to free navigation on the river. No attempt will be made by the permittee to prevent the full and free use by the public of the river at or adjacent to the authorized work for reason other than safety. NCDOT shall not modify the design of the temporary work bridges to provide an unobstructed main channel less than fifty feet wide, with no vertical structural obstructions from the work bridges extending into the opening.

Historic Property

cc. NCDOT shall leave Bridge No. 46, which currently carries US 29-70 over the Yadkin River in the southbound direction, in place, due to its historical significance. NCDOT shall close the bridge to vehicular traffic, but it will serve pedestrian and bicycle traffic. NCDOT shall work out ownership and maintenance responsibilities with the Rowan and Davidson County Commissioners, the Transportation Museum, and the North Carolina State Historic Preservation Office.

NORTH CAROLINA

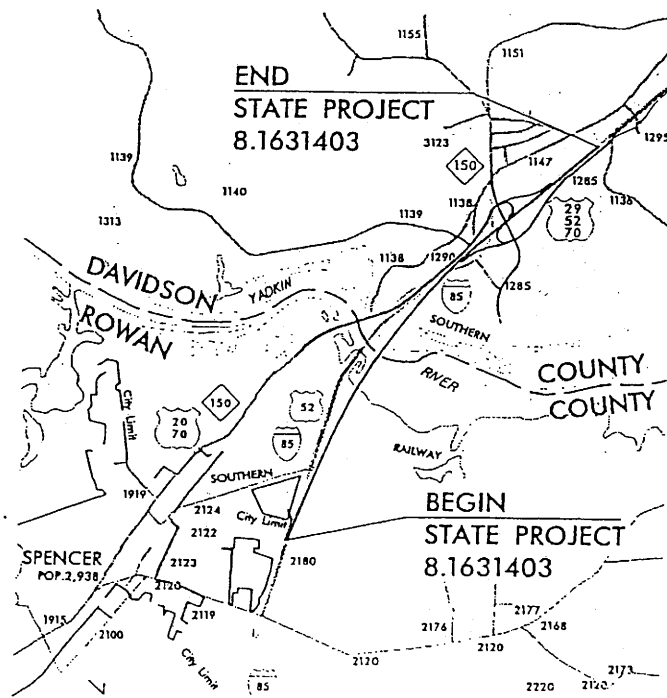
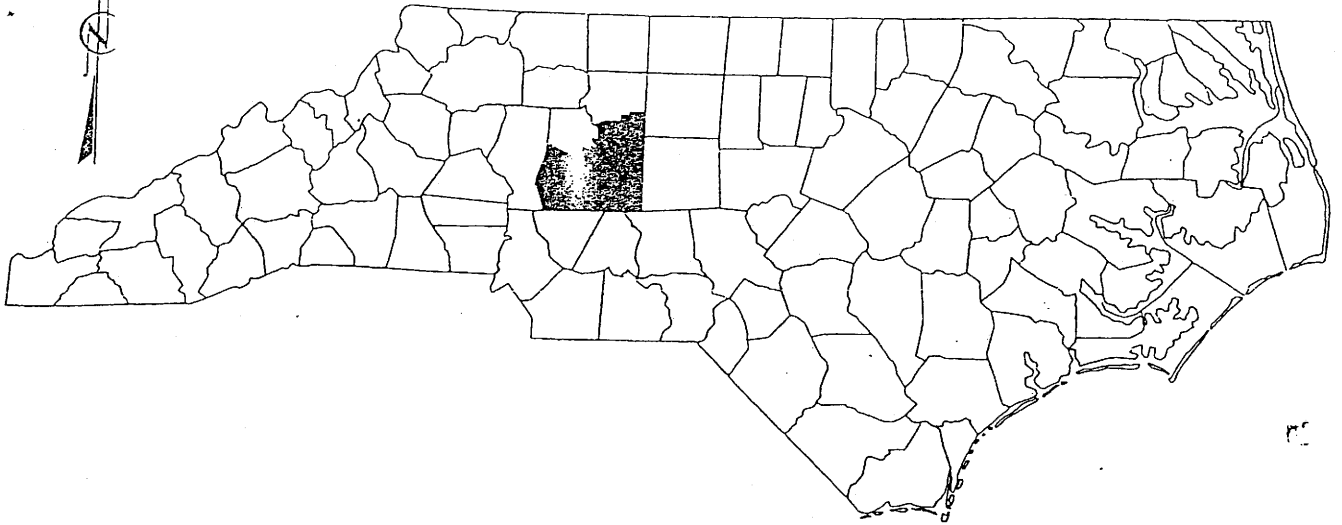

VICINITY MAPS

NCDOT

DIVISION OF HIGHWAYS
DAVIDSON/ROWAN

PROJECT: 8.1631403 (I-2304AA)

I-85 FROM NORTH OF SR 2120 IN
ROWAN COUNTY TO NORTH OF
NC 150 IN DAVIDSON COUNTY

SHEET 1 OF 21

5/7/05

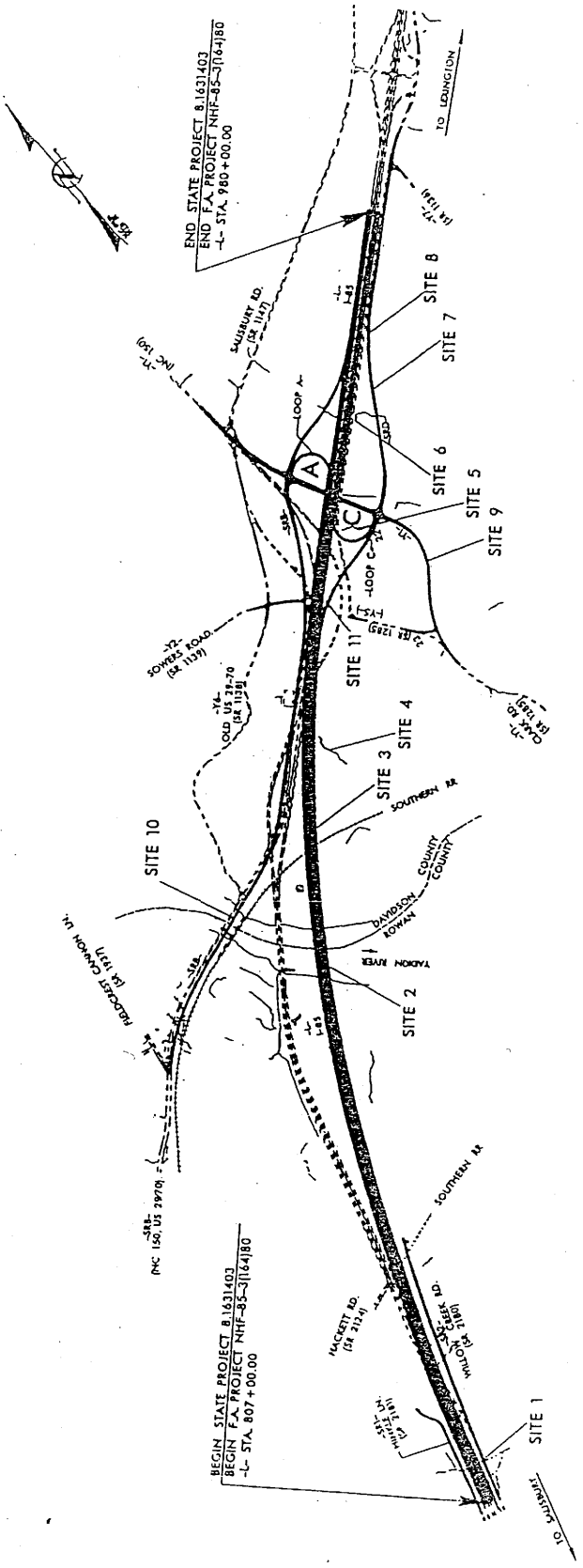

NCDOT

DIVISION OF HIGHWAYS
 DAVIDSON/ROWAN

PROJECT: 8.1631403 (I-2304AA)

I-85 FROM NORTH OF SR 2120 IN
 ROWAN COUNTY TO NORTH OF
 NC 150 IN DAVIDSON COUNTY

SHEET 2 OF 21 5/8/03

SITE MAP

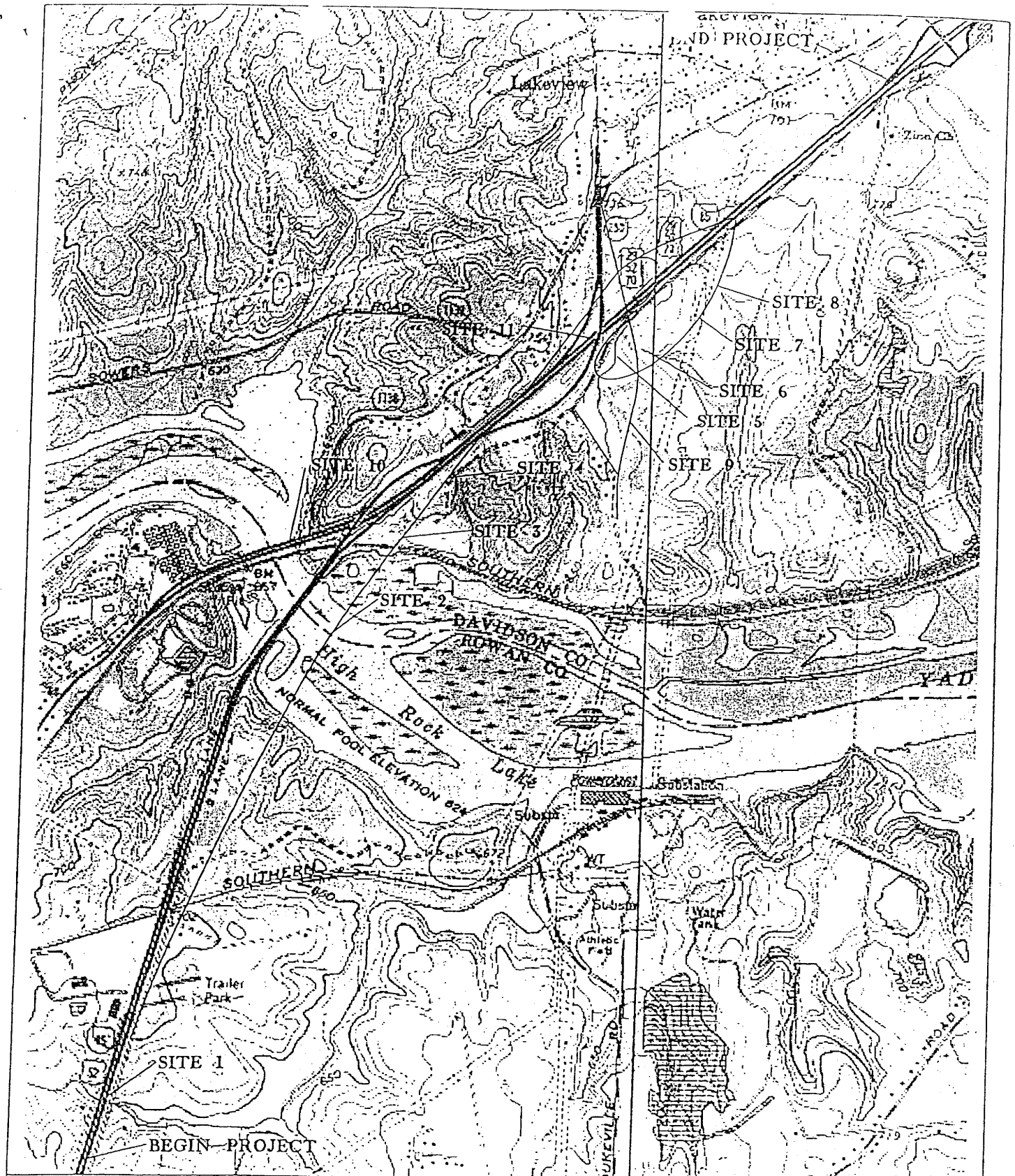









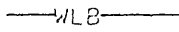
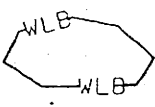
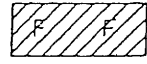

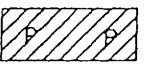

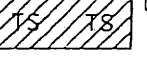

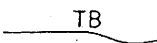
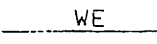
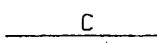
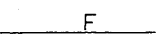

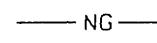
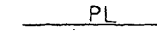
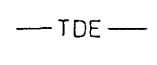
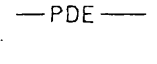
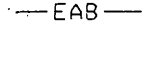
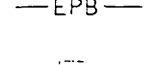
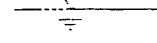
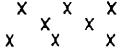

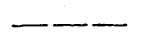
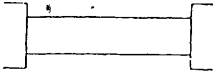
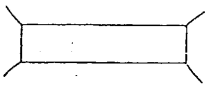
TOPO MAP
 SCALE 1" = 2000'

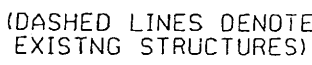
NCDOT
 DIVISION OF HIGHWAYS
 DAVIDSON/ROWAN COUNTY
 PROJECT: 8.1631403 (I-2304AA)
 I-85 FROM NORTH OF SR 2120 IN
 ROWAN COUNTY TO NORTH OF
 NC 150 IN DAVIDSON COUNTY

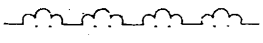
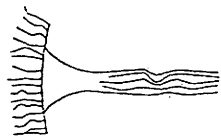
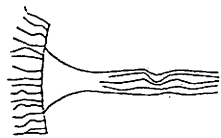
SHEET 3 OF 21 5/7/02

WETLAND LEGEND

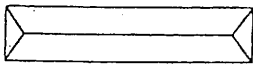
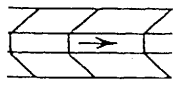
-  WETLAND BOUNDARY
-  WETLAND
-  DENOTES FILL IN WETLAND
-  DENOTES FILL IN SURFACE WATER
-  DENOTES FILL IN SURFACE WATER (POND)
-  DENOTES TEMPORARY FILL IN WETLAND
-  DENOTES EXCAVATION IN WETLAND
-  DENOTES TEMPORARY FILL IN SURFACE WATER
-  DENOTES MECHANIZED CLEARING
-  FLOW DIRECTION
-  TOP OF BANK
-  EDGE OF WATER
-  PROP. LIMIT OF CUT
-  PROP. LIMIT OF FILL
-  PROP. RIGHT OF WAY
-  NATURAL GROUND
-  PROPERTY LINE
-  TEMP. DRAINAGE EASEMENT
-  PERMANENT DRAINAGE EASEMENT
-  EXIST. ENDANGERED ANIMAL BOUNDARY
-  EXIST. ENDANGERED PLANT BOUNDARY
-  WATER SURFACE
-  LIVE STAKES
-  BOULDER
-  CORE FIBER ROLLS
-  PROPOSED BRIDGE
-  PROPOSED BOX CULVERT
-  PROPOSED PIPE CULVERT
12"-48"
PIPES
54" PIPES
& ABOVE
-  (DASHED LINES DENOTE EXISTING STRUCTURES)
-  SINGLE TREE
-  WOODS LINE
-  DRAINAGE INLET
-  ROOTWAD
-  RIP RAP
-  ADJACENT PROPERTY OWNER OR PARCEL NUMBER IF AVAILABLE
-  PREFORMED SCOUR HOLE
-  LEVEL SPREADER (LS)
-  DITCH / GRASS SWALE

NCDOT
 DIVISION OF HIGHWAYS
 DAVIDSON/ROWAN COUNTY
 PROJECT: 8.1631403 (I-2304AA)
 I-85 FROM NORTH OF SR 2120 IN
 ROWAN COUNTY TO NORTH OF
 NC 150 IN DAVIDSON COUNTY

SHEET **4** OF **21**

5/7/03

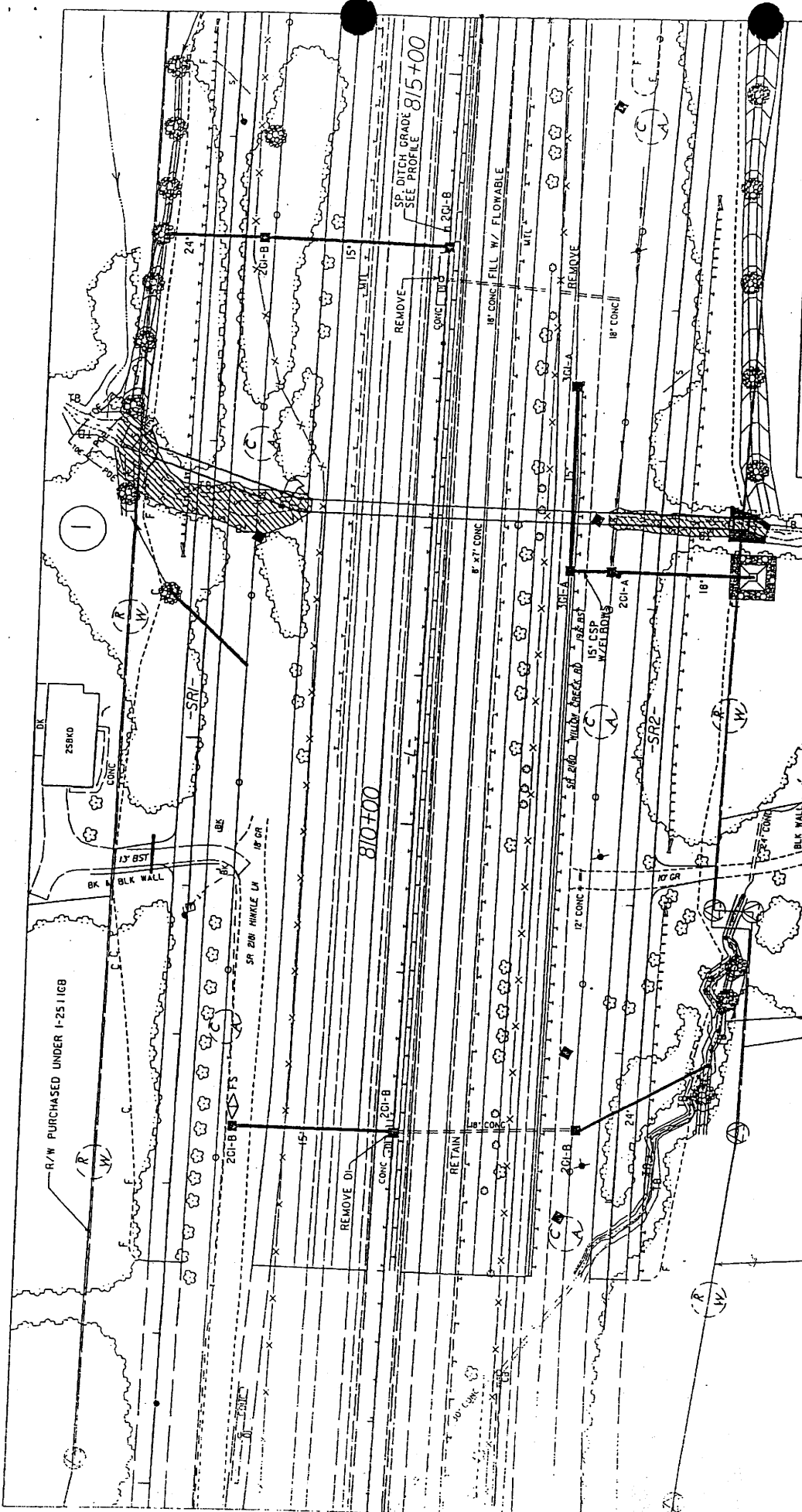

NCDOT
 DIVISION OF HIGHWAYS
 DAVIDSON/ROWAN
 PROJECT: 81651403 (I-2304.A.A)
 I-85 FROM NORTH OF SR 2120 IN
 ROWAN COUNTY TO NORTH OF
 NC 150 IN DAVIDSON COUNTY

PLAN VIEW
 STREAM
 IMPACTS
 SITE I

TO BE PERMITTED
 UNDER I-25 I/CB

NAD '83

SCALE 1" = 100'

SHEET 5 OF 21

6/25/03

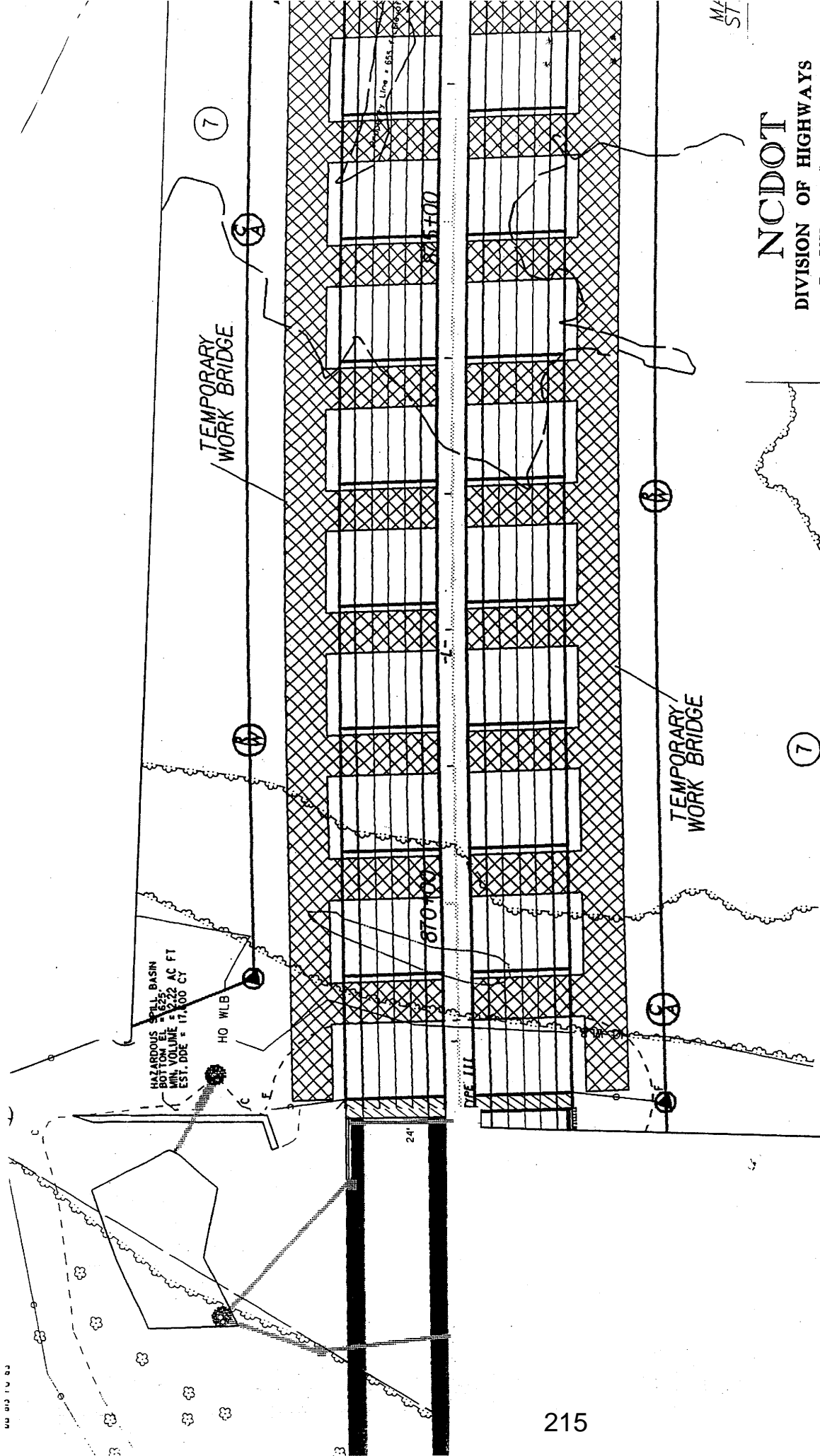

HAZARDOUS SPILL BASIN
 BOTTOM EL = 1625
 MIN. VOLUME = 222 AC FT
 EST. DDE = 11,000 CFS

HO WLB

TEMPORARY WORK BRIDGE

TEMPORARY WORK BRIDGE

NCDOT
 DIVISION OF HIGHWAYS
 DAVIDSON/ROWAN
 PROJECT: 8.1651403 (I-2304AA)

I-85 FROM NORTH OF SR 2120 IN
 ROWAN COUNTY TO NORTH OF
 NC 150 IN DAVIDSON COUNTY

Rev: 10/04
 SHEET 6 OF 21
 3/2/04

PLAN VIEW
 STREAM
 IMPACTS
 SITE 2

SCALE 1" = 100'

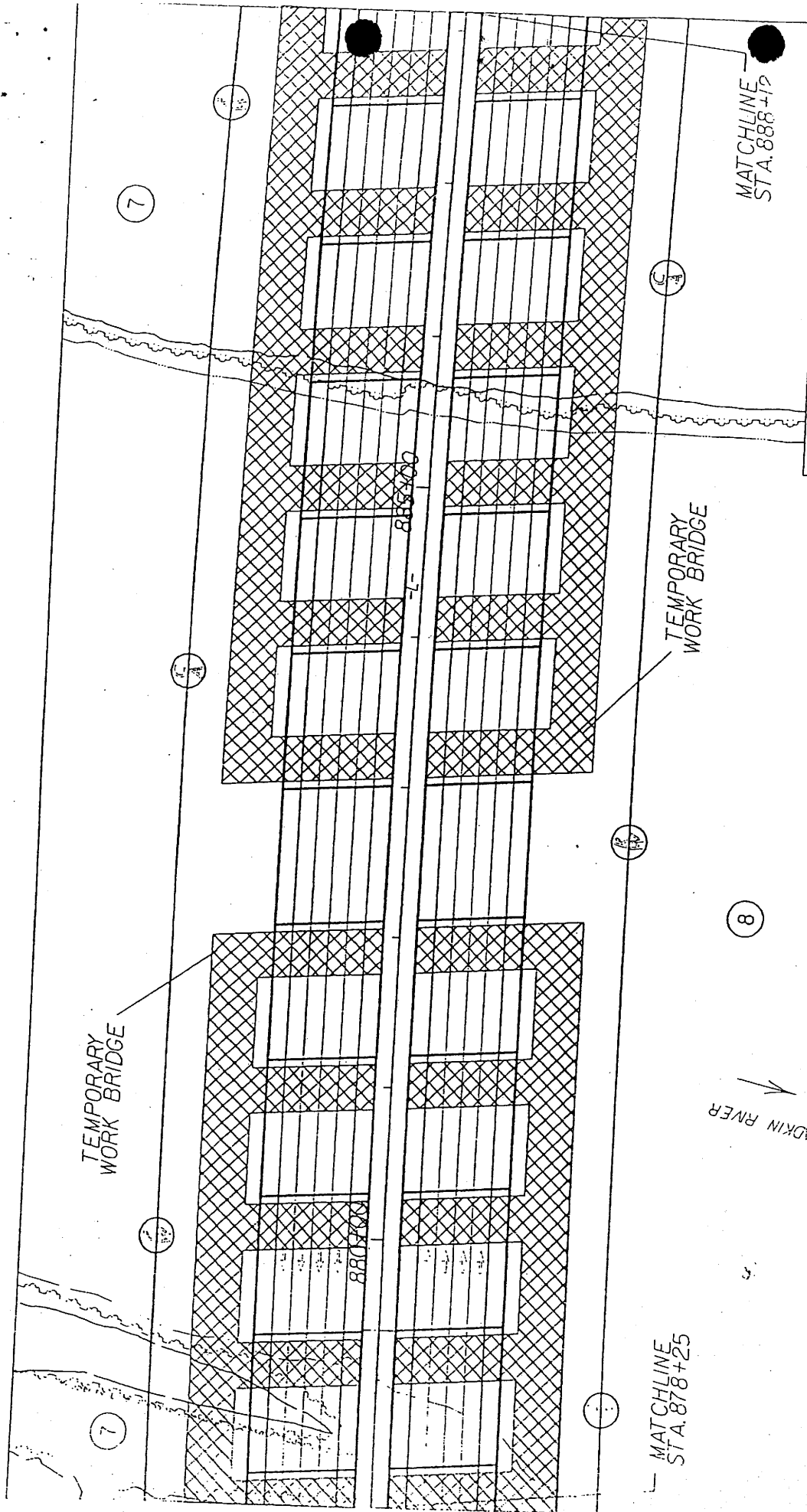

NCDOT
 DIVISION OF HIGHWAYS
 DAVIDSON/ROWAN
 PROJECT: 8.1631403 (I-2304.AA)
 I-85 FROM NORTH OF SR 2120 IN
 ROWAN COUNTY TO NORTH OF
 NC 150 IN DAVIDSON COUNTY

PLAN VIEW
 STREAM
 IMPACTS
 SITE 2

SCALE 1" = 100'

SHEET 7 OF 21

8/30/02

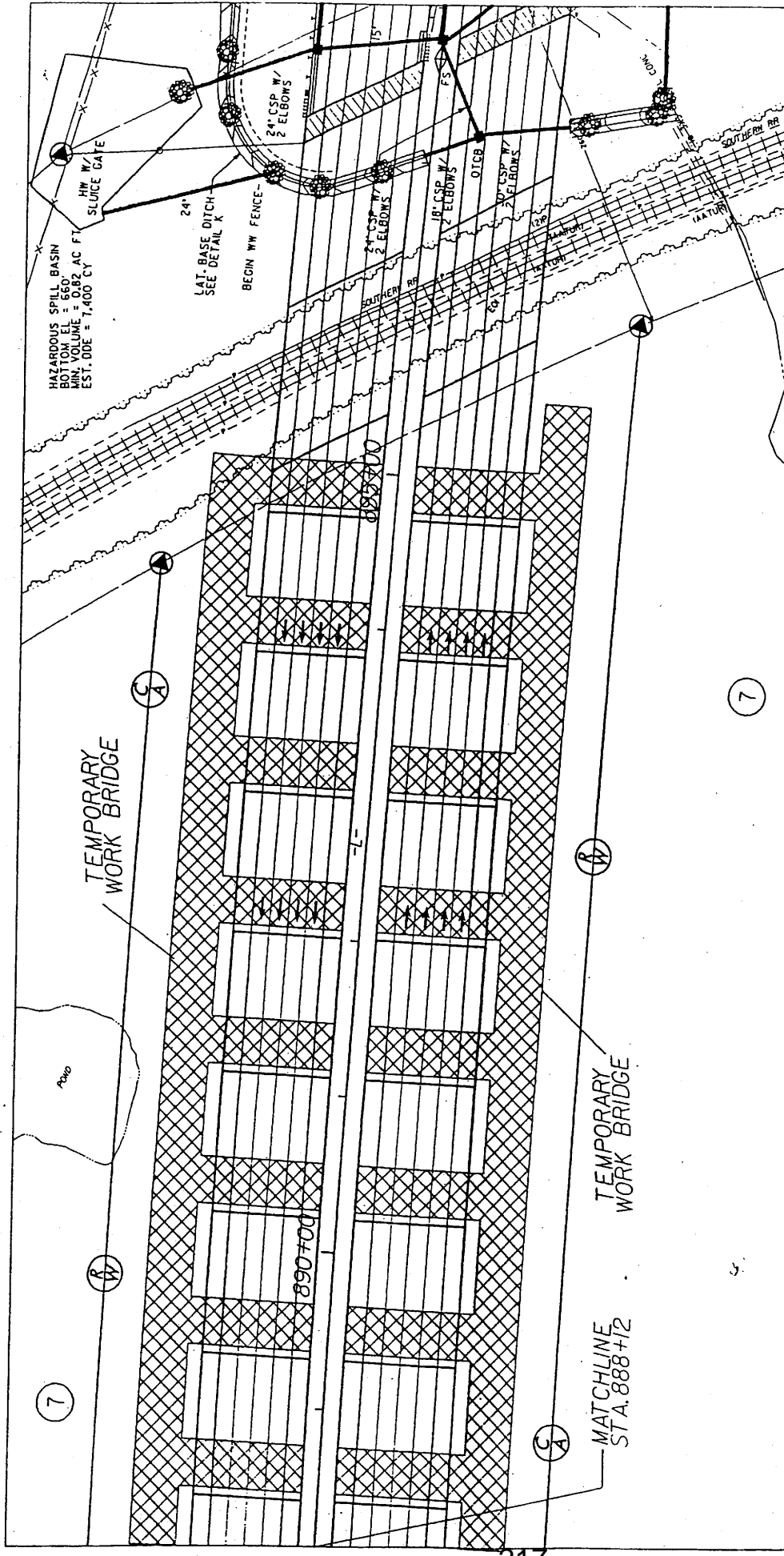

NCDOT
 DIVISION OF HIGHWAYS
 DAVIDSON/ROWAN
 PROJECT: 8.1631403 (I-2304AA)
 I-85 FROM NORTH OF SR 2120 IN
 ROWAN COUNTY TO NORTH OF
 NC 150 IN DAVIDSON COUNTY
 Rev: 10/04
 SHEET 8 OF 21 3/2/04

PLAN VIEW
 STREAM
 IMPACTS
 SITE 2
 SCALE 1" = 100'
 NAD '83

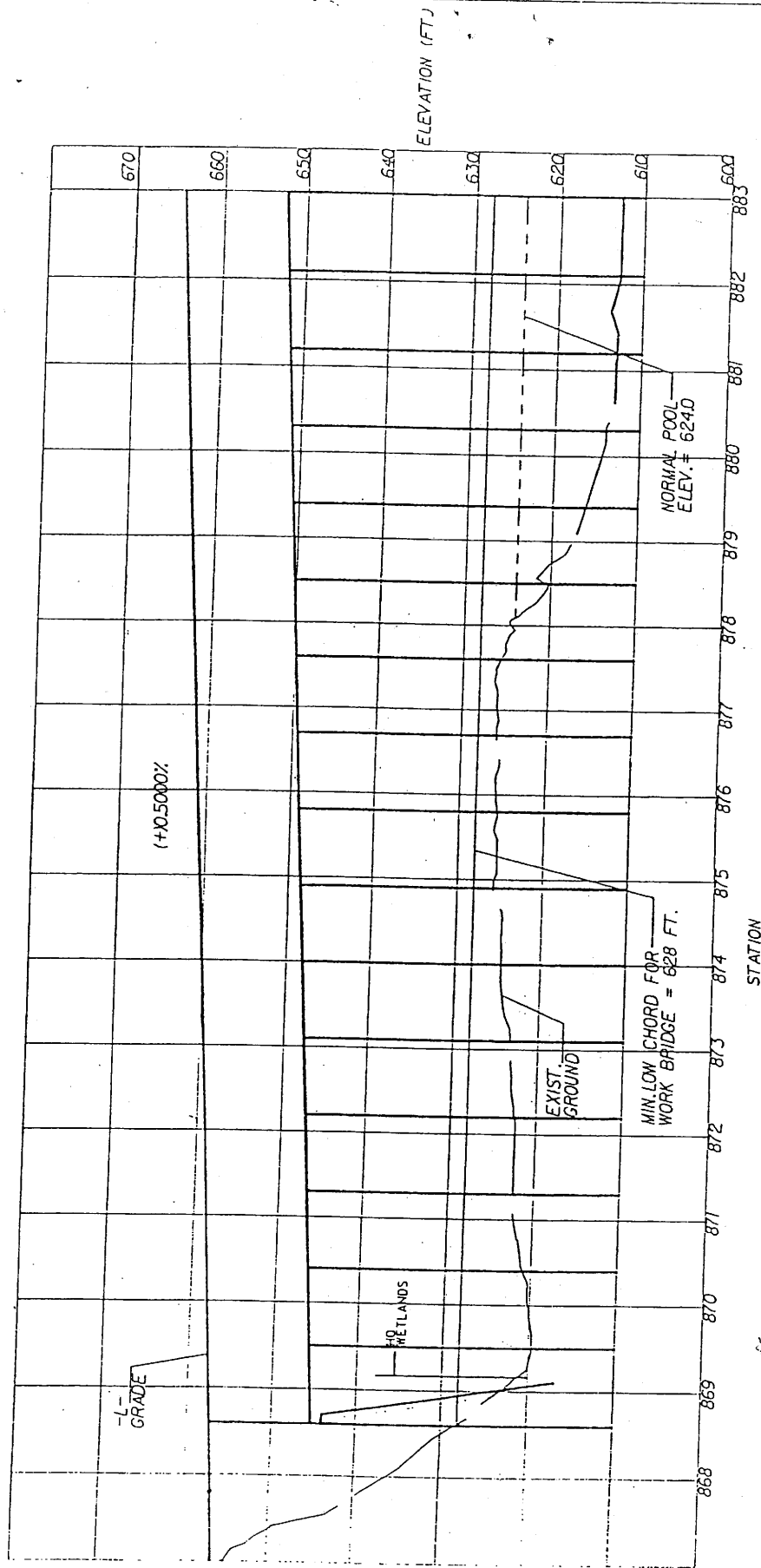

NCDOT

DIVISION OF HIGHWAYS

DAVIDSON/ROWAN

PROJECT: 8.1631403 (I-2304.A.A)

I-85 FROM NORTH OF SR 2120 IN
 ROWAN COUNTY TO NORTH OF
 NC 150 IN DAVIDSON COUNTY

13

SHEET 9 OF 21

5/7/03

PROFILE VIEW
 SITE 2

SCALE 1" = 200' HORIZONTAL
 1" = 20' VERTICAL

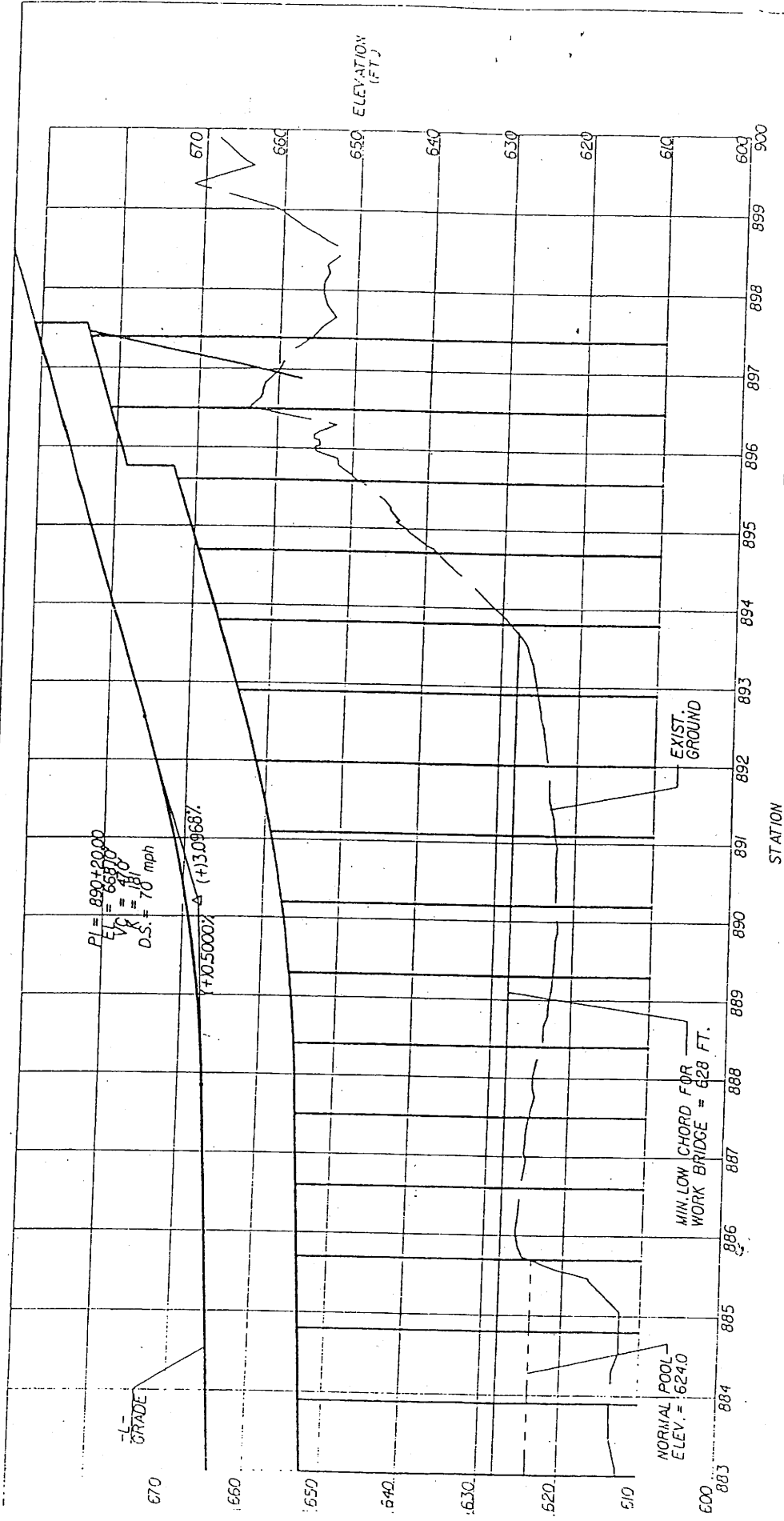

NCDOT
 DIVISION OF HIGHWAYS
 DAVIDSON/ROWAN
 PROJECT: 8.1631-403 (I-2304.A.A)
 I-85 FROM NORTH OF SR 2120 IN
 ROWAN COUNTY TO NORTH OF
 NC 150 IN DAVIDSON COUNTY

PROFILE VIEW
SITE 2
SCALE 1" = 200' HORIZONTAL
1" = 20' VERTICAL

SHEET 10 OF 21
 5/7/03

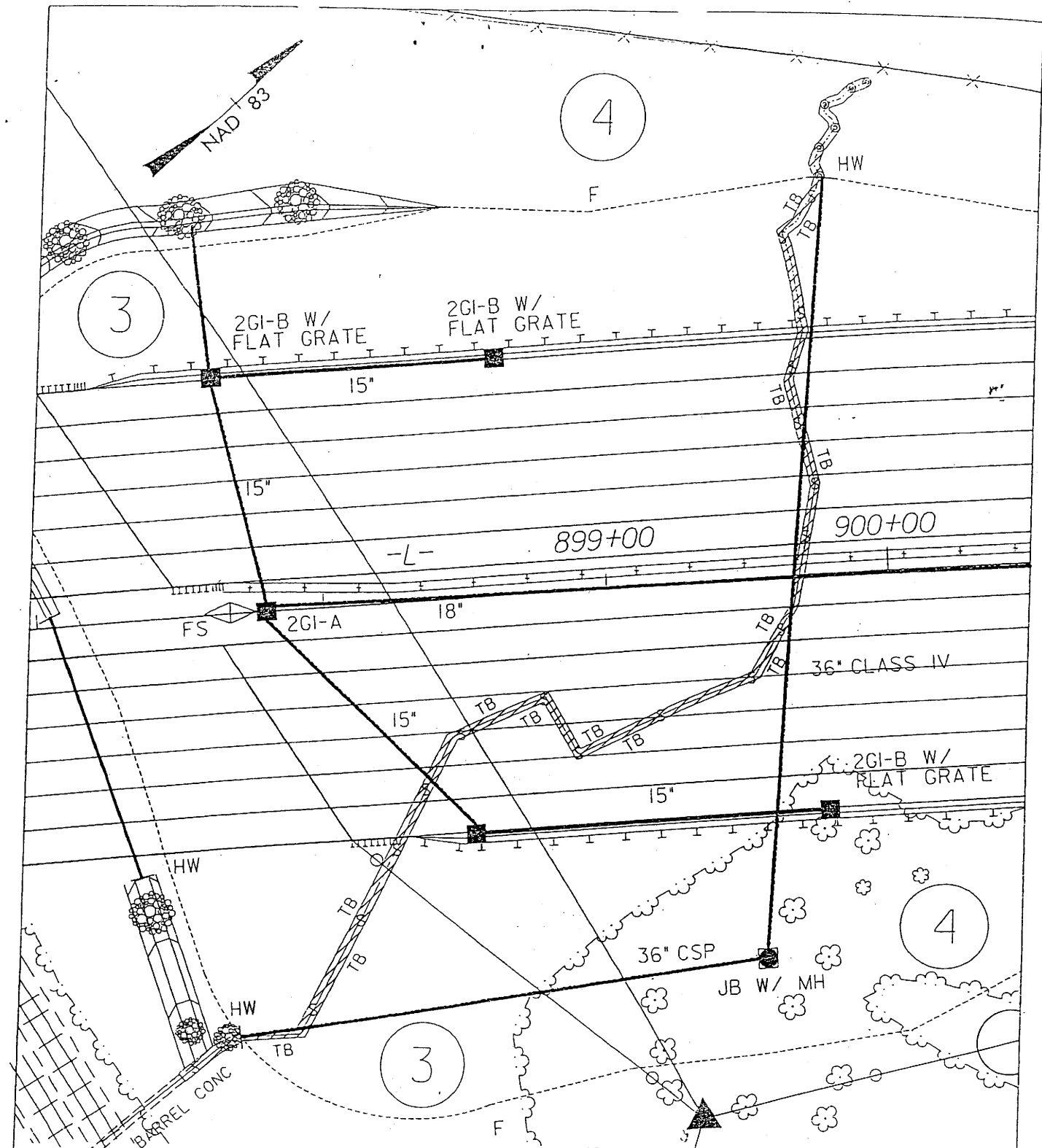

PLAN VIEW
 STREAM
 IMPACTS
 SITE 5
 SCALE 1" = 50'

NCDOT
 DIVISION OF HIGHWAYS
 DAVIDSON/ROWAN
 PROJECT: 8.1631405 (I-2504AA)
 I-85 FROM NORTH OF SR 2120 IN
 ROWAN COUNTY TO NORTH OF
 NC 150 IN DAVIDSON COUNTY

SHEET 11 OF 21

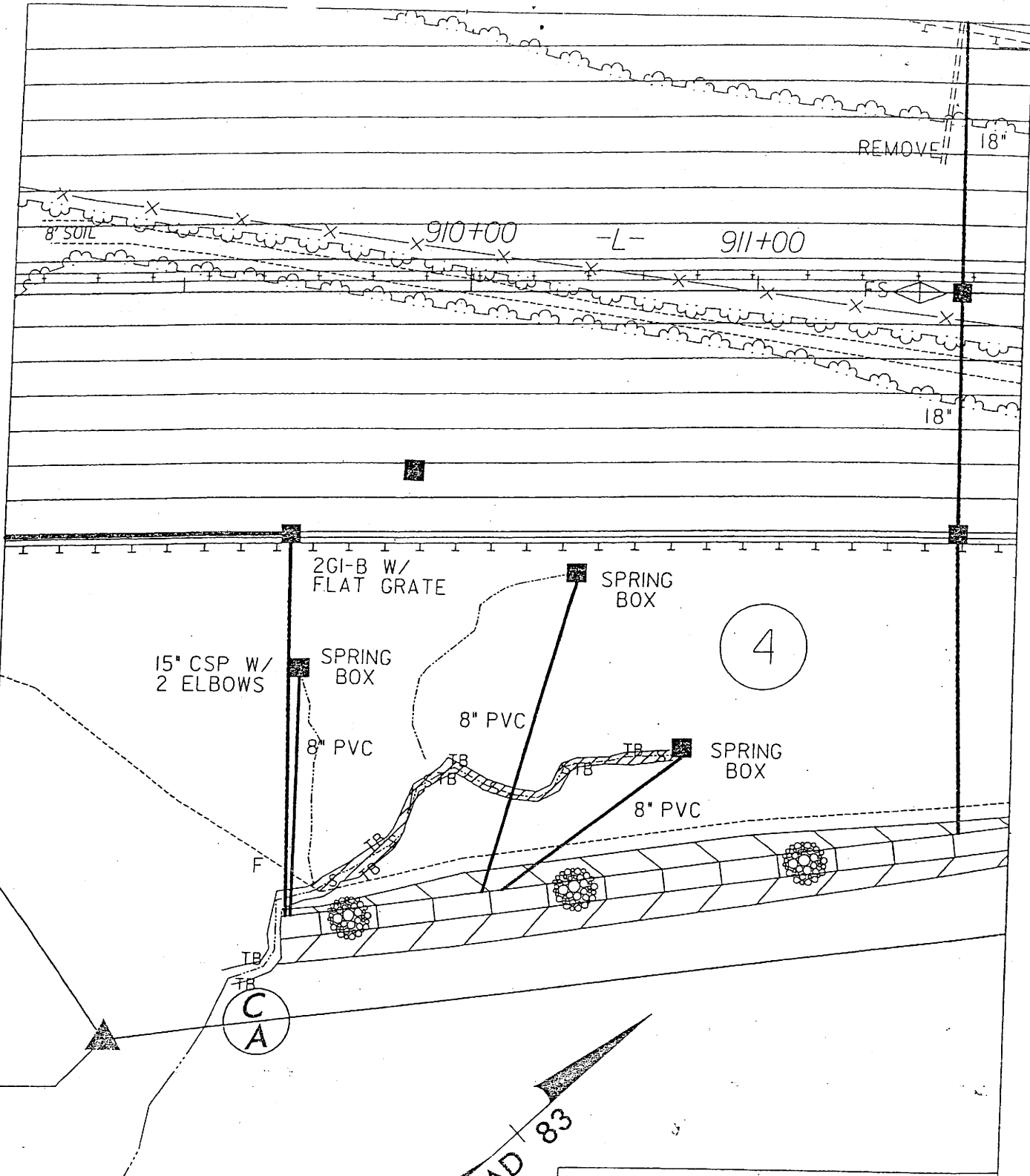

PLAN VIEW
 SITE 4
 STREAM
 IMPACTS
 SCALE 1" = 50'

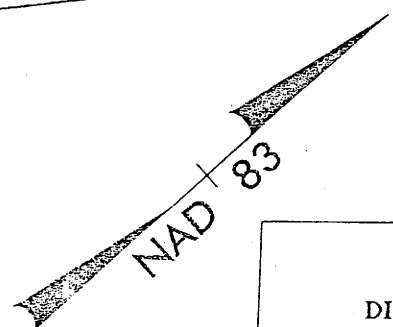

NCDOT
 DIVISION OF HIGHWAYS
 DAVIDSON/ROWAN COUNTY
 PROJECT: 8.1651403 (I-2304AA)
 I-85 FROM NORTH OF SR 2120 IN
 ROWAN COUNTY TO NORTH OF
 NC 150 IN DAVIDSON COUNTY

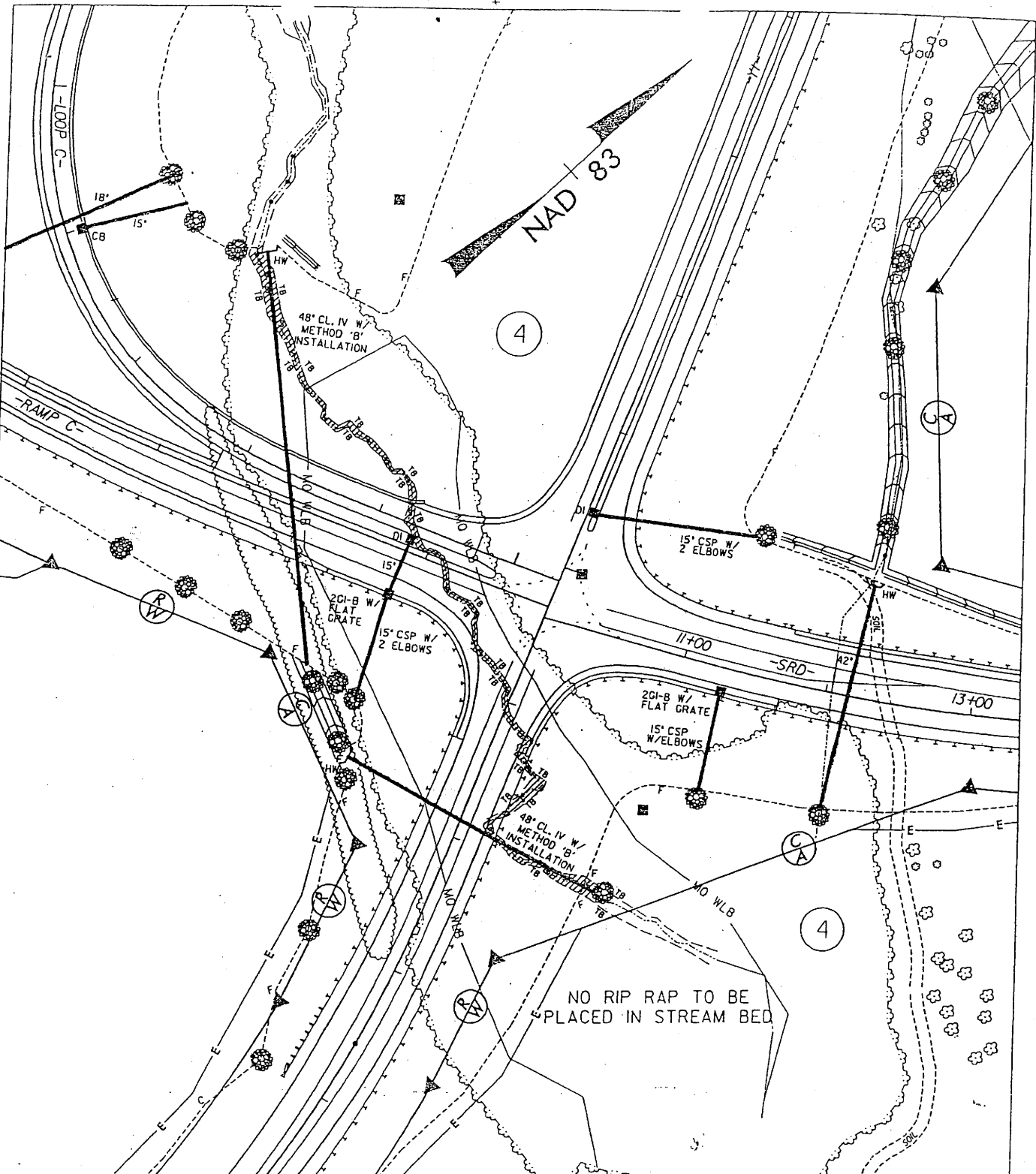

PLAN VIEW
 STREAM
 IMPACTS
 SITE 5
 SCALE 1" = 100'

NCDOT
 DIVISION OF HIGHWAYS
 DAVIDSON/ROWAN COUNTY
 PROJECT: 8.1631403 (I-2504AA)
 I-85 FROM NORTH OF SR 2120 IN
 ROWAN COUNTY TO NORTH OF
 NC 150 IN DAVIDSON COUNTY

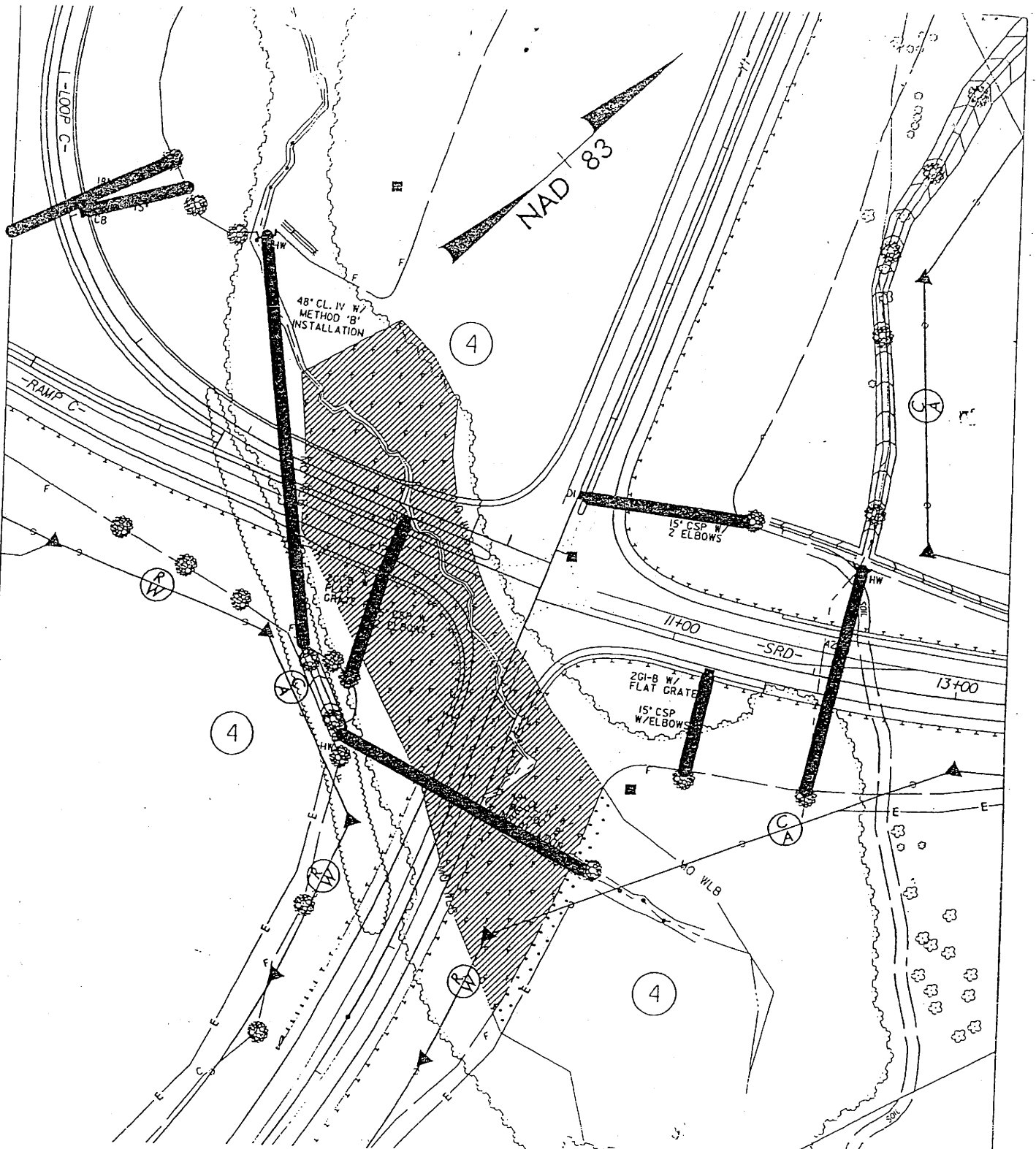

PLAN VIEW
 WETLAND
 IMPACTS
 SITE 5
 SCALE 1" = 100'

NCDOT
 DIVISION OF HIGHWAYS
 DAVIDSON/ROWAN COUNTY
 PROJECT: 8.1631403 (I-2304AA)
 I-85 FROM NORTH OF SR 2120 IN
 ROWAN COUNTY TO NORTH OF
 NC 150 IN DAVIDSON COUNTY

SHEET 14 OF 21

5/7/03

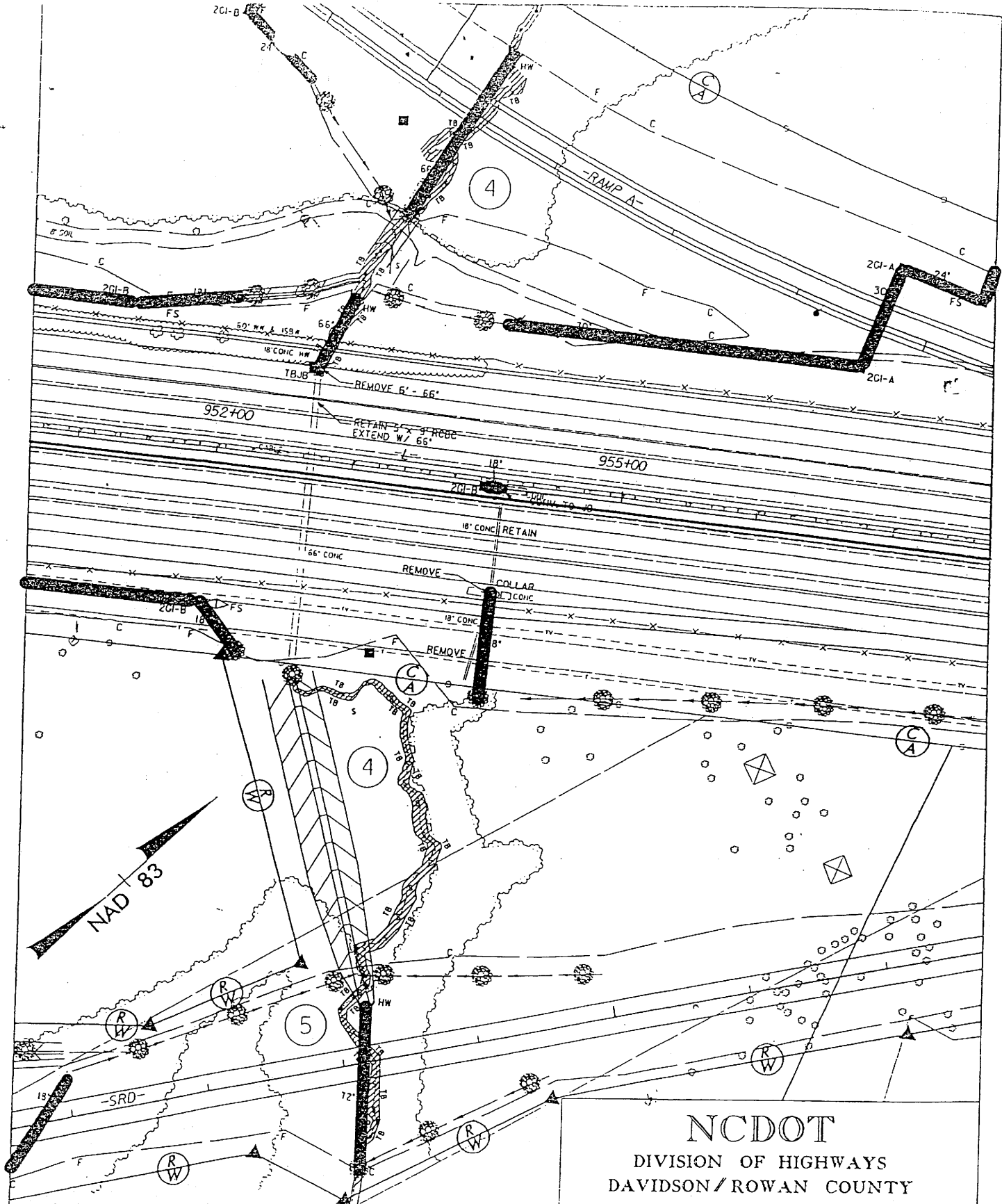

PLAN VIEW
 STREAM
 IMPACTS
 SITE 6

SCALE
 1" = 100'

NCDOT
 DIVISION OF HIGHWAYS
 DAVIDSON/ROWAN COUNTY
 PROJECT: 8.1631403 (I-2304AA)
 I-85 FROM NORTH OF SR 2120 IN
 ROWAN COUNTY TO NORTH OF
 NC 150 IN DAVIDSON COUNTY
 SHEET 15 OF 21

5/7/05

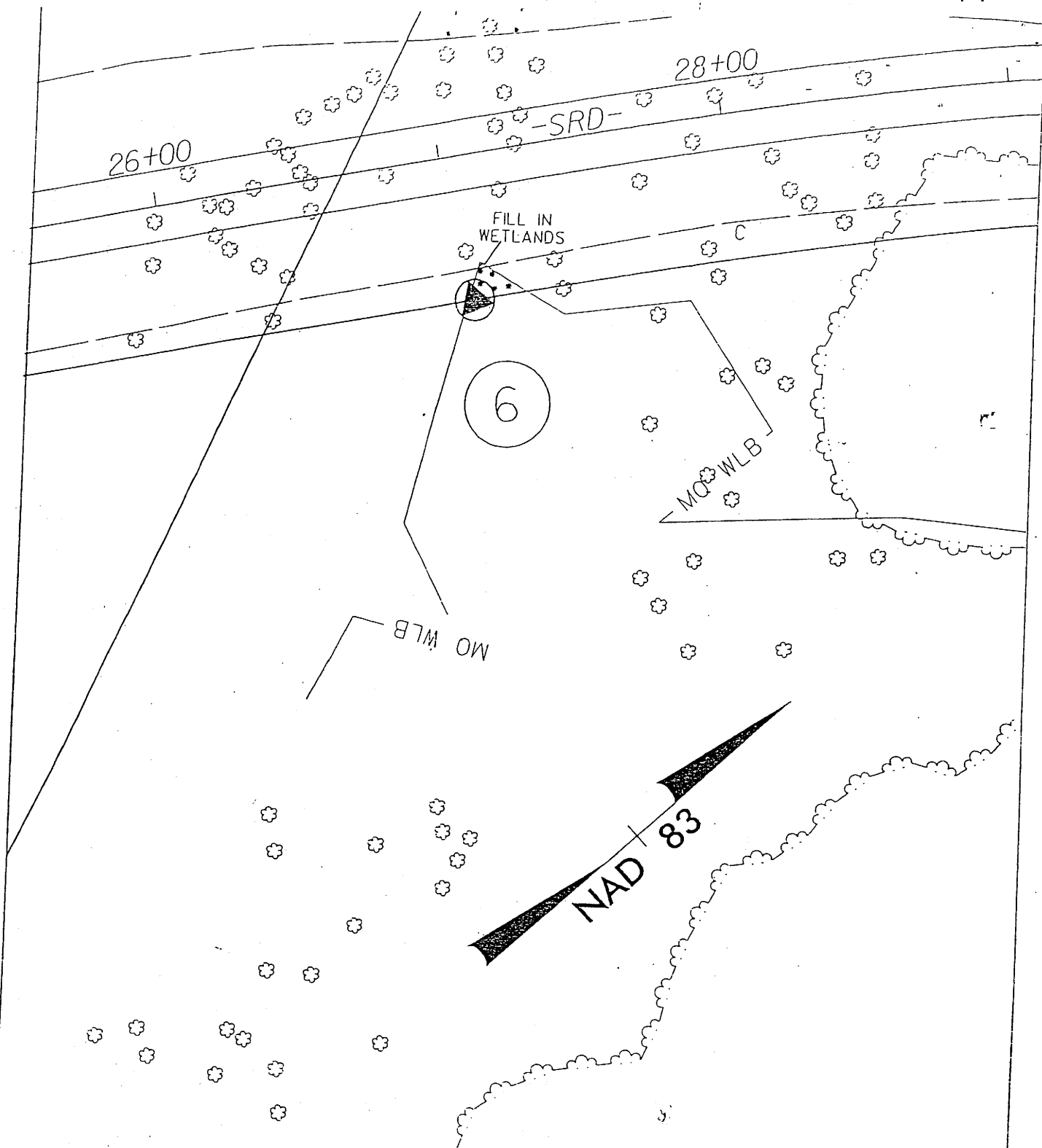

PLAN VIEW
 WETLAND
 IMPACTS
 SITE 7
 SCALE 1" = 50'

NCDOT
 DIVISION OF HIGHWAYS
 DAVIDSON/ROWAN COUNTY
 PROJECT: 8.1631405 (I-2504AA)
 I-85 FROM NORTH OF SR 2120 IN
 ROWAN COUNTY TO NORTH OF
 NC 150 IN DAVIDSON COUNTY

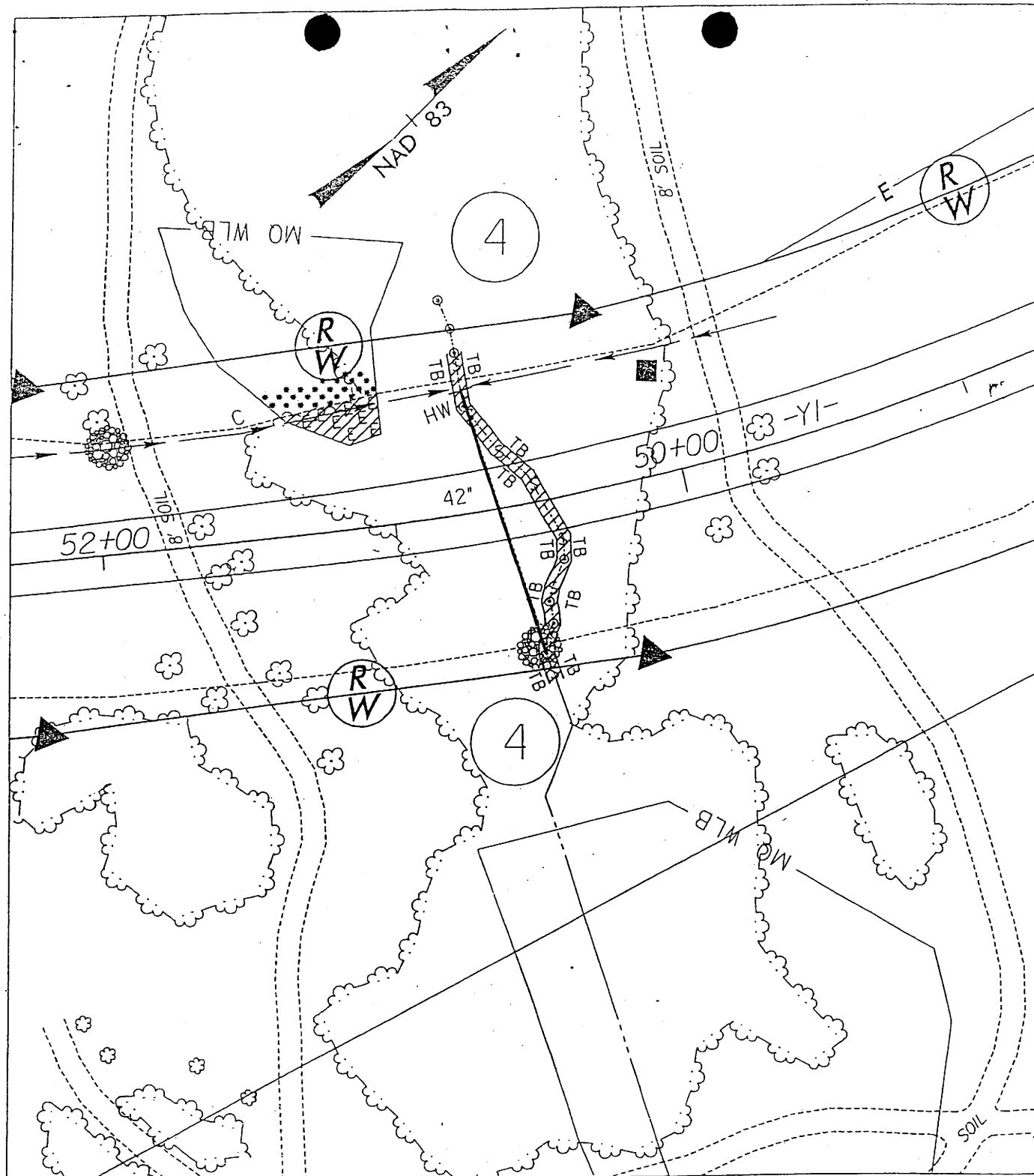

PLAN VIEW
 STREAM & WETLAND
 IMPACTS
 SITE 9
 SCALE 1" = 50'

NCDOT
 DIVISION OF HIGHWAYS
 DAVIDSON/ROWAN
 PROJECT: 8.1651405 (I-2504AA)
 I-85 FROM NORTH OF SR 2120 IN
 ROWAN COUNTY TO NORTH OF
 NC 150 IN DAVIDSON COUNTY
 SHEET 17 OF 21
 6/25/03

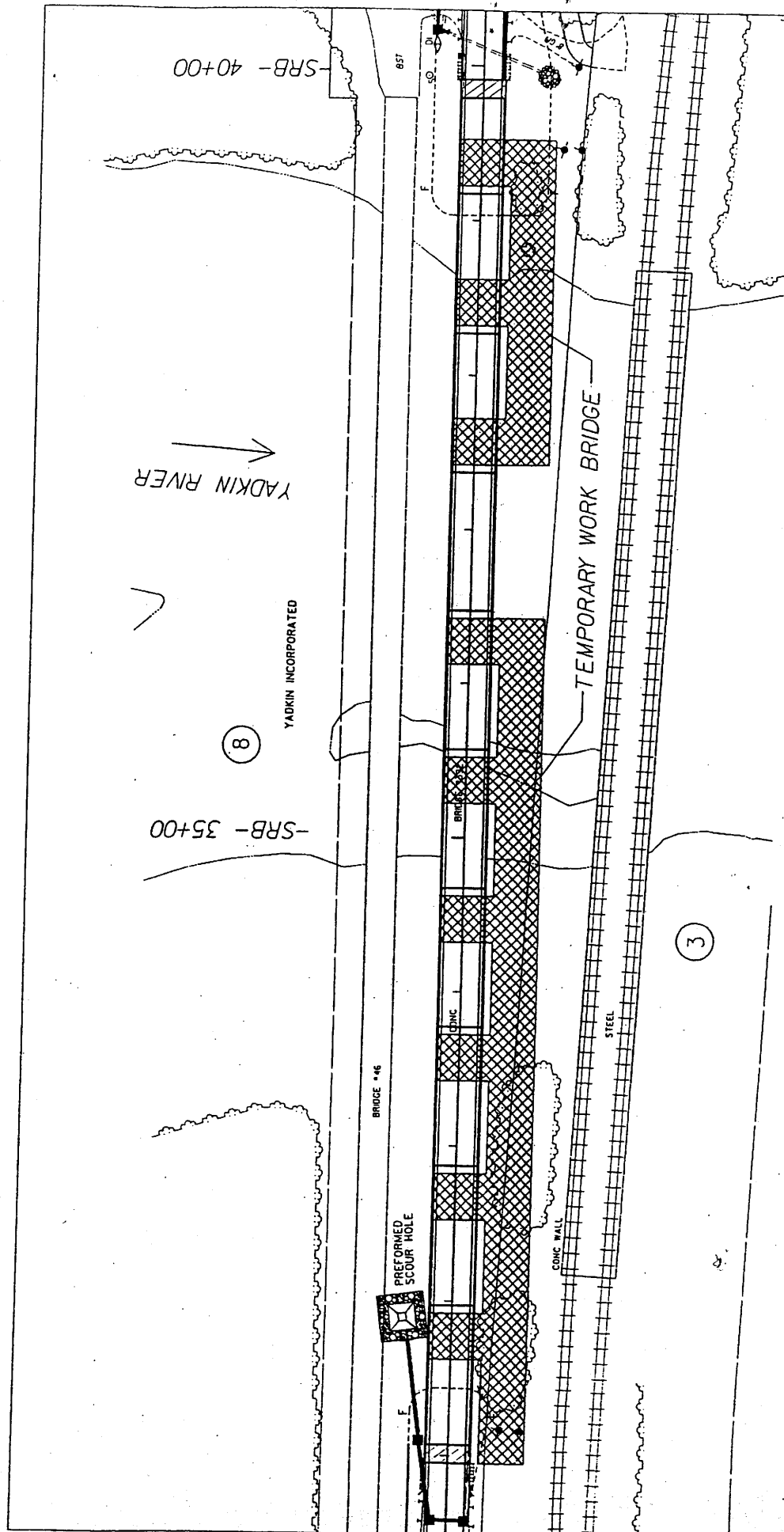

NCDOT
 DIVISION OF HIGHWAYS
 DAVIDSON/ROWAN
 PROJECT: 8.1631403 (I-2304.AA)
 I-85 FROM NORTH OF SR 2120 IN
 ROWAN COUNTY TO NORTH OF
 NC 150 IN DAVIDSON COUNTY
 Rev: 10/04
 SHEET 18 OF 21
 3/2/04

PLAN VIEW
 STREAM
 IMPACTS
 SITE 10
 SCALE 1" = 100'

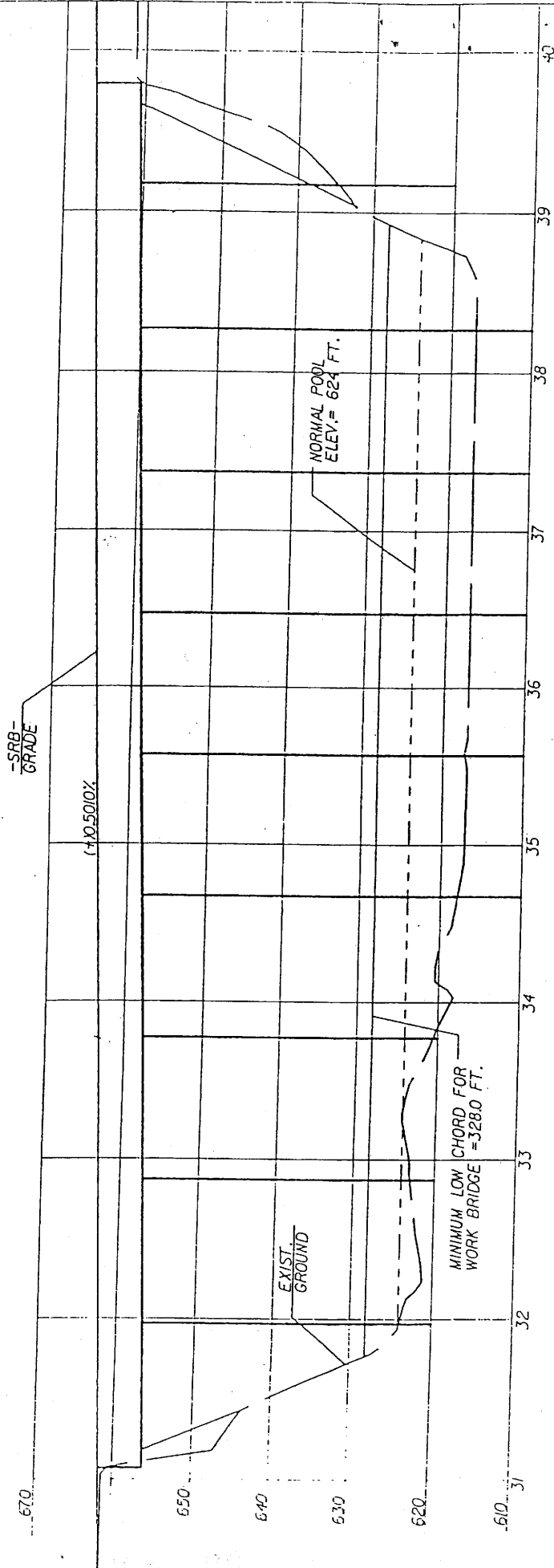

NCDOT
 DIVISION OF HIGHWAYS
 DAVIDSON/ROWAN
 PROJECT: 81631403 (I-2304.A.A)

I-85 FROM NORTH OF SR 2120 IN
 ROWAN COUNTY TO NORTH OF
 NC 150 IN DAVIDSON COUNTY

SHEET 19 OF 21

5/7/05

PROFILE VIEW
 SITE 10

SCALE 1" = 100' HORIZONTAL
 1" = 20' VERTICAL

PROPERTY OWNERS

NAMES AND ADDRESSES

PARCEL NO.	NAMES	ADDRESSES
1	HINKLE, PAUL P.	455 HINKLE LANE SALISBURY, NC 28144-8555
2	HINKLE, JR., HOLLIS L.	655 HACKETT ST. SALISBURY, NC 28144-7769
3	SOUTHERN RAIL CO.	8 NORTH JEFFERSON ST. ROANOKE, VA 24042
4	GRUBB, ROBERT L.	P.O. BOX 388 HIGH POINT, NC 27260
5	DUKE POWER COMPANY	P.O. BOX 1090 CHARLOTTE, NC 28201-1090
6	FALCON DEVELOPMENT GROUP INC.	1329 SOUTH MAIN ST. SALISBURY, NC 28144
7	ALUMINUM COMPANY OF AMERICA	P.O. BOX 688 BADIN, NC 28009
8	YADKIN INCORPORATED	P.O. BOX 688 BADIN, NC 28009

NCDOT

DIVISION OF HIGHWAYS
DAVIDSON/ROWAN COUNTY
PROJECT: 8.1631403 (I-2304AA)

I-85 FROM NORTH OF SR 2120 IN
ROWAN COUNTY TO NORTH OF
NC 150 IN DAVIDSON COUNTY

WETLANDS IMPACT PERMIT SUMMARY

Site No.	Station (From/To)	Structure Size / Type	Fill In Wetlands (ac)	Temp. Fill In Wetlands (ac)	Excavation In Wetlands (ac)	Mechanized Clearing (Method III) (ac)	Fill In SW (Natural) (ac)	Fill In SW (Pond) (ac)	Temp. Fill In SW (ac)	Existing Channel Impacted (ft)	Natural Stream Design (ft)
1	812+00 -L-	8' X 7' RCBC					0.1129			262	
2	868+60 TO 897+27 -L-	BRIDGE									
3	900+00 -L-	36" RCP					0.0378			485	
4	910+00 -L-	8" PVC					0.0138			190	
5	9+00 -LOOP C-	48" RCP					0.0705			619	
6	9+00 -LOOP C-		1.0385			0.0404					
7	952+60 -L-	72"					0.1343			863	
8	27+00 -SRD-		0.000086			0.0027					
9	963+00 -L-						0.0075			97	
10	50+50 -Y1-	42" RCP			0.0077	0.0088	0.0146			128	
11	31+07 TO 39+79 -SRB- 1+00 -RAMP C-	BRIDGE									
TOTALS:			1.04	0.00	0.01	0.05	0.39	0.00	0.00	2644	0.00

NCDOT

DIVISION OF HIGHWAYS
 DAVIDSON / ROWAN COUNTY
 PROJECT 8.1631403 (I-2304AA)
 I-85 FROM NORTH OF SR 2120 IN
 ROWAN COUNTY TO NORTH OF
 NC 150 IN DAVIDSON COUNTY

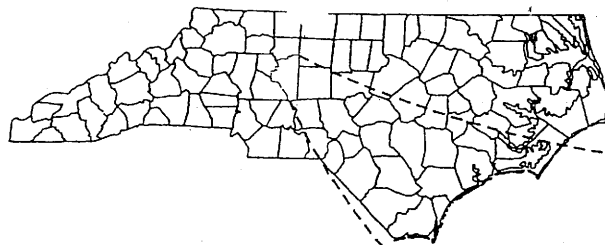

DAVIDSON COUNTY

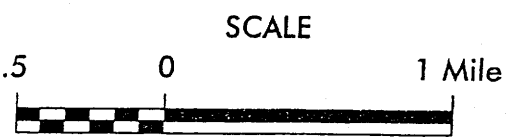
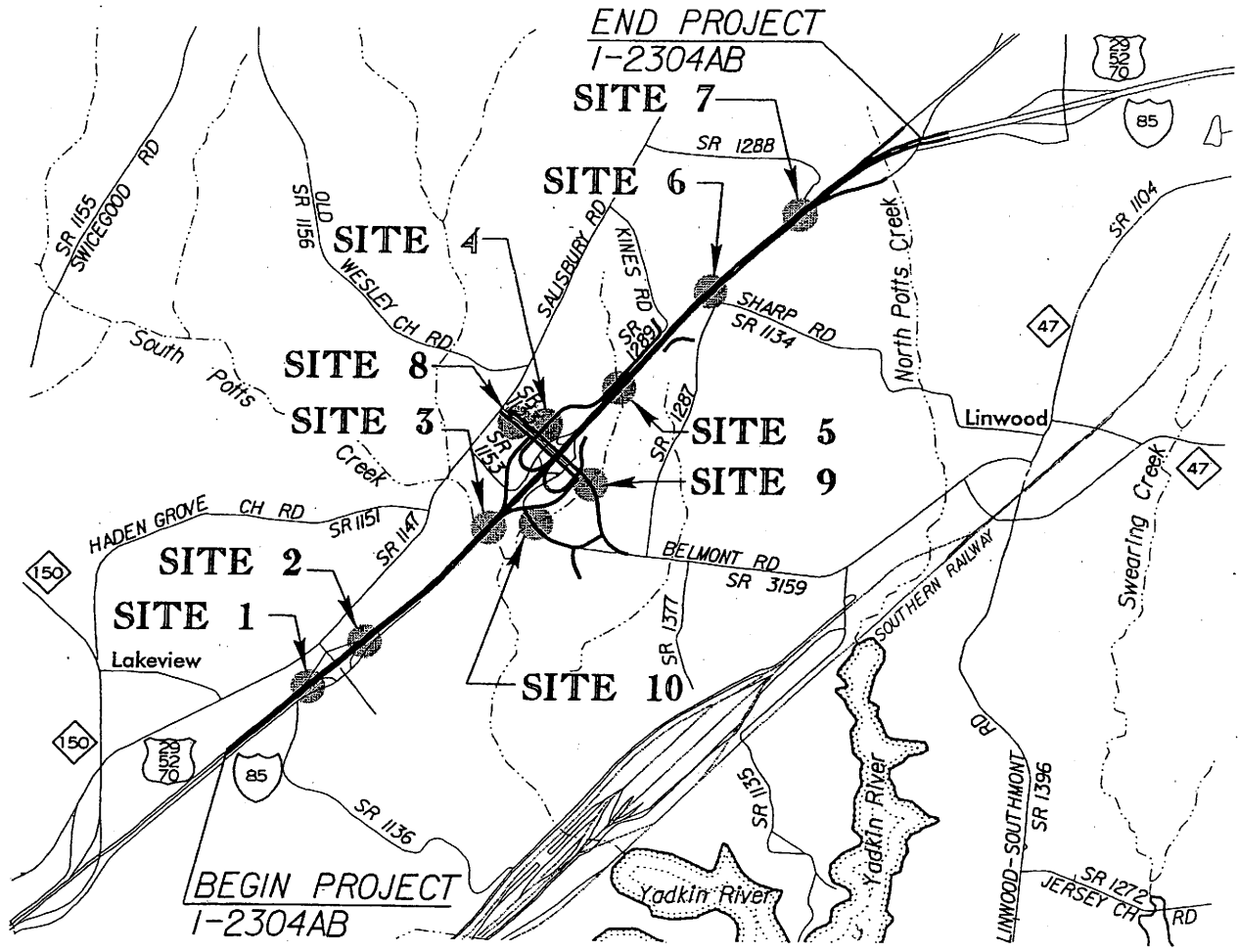
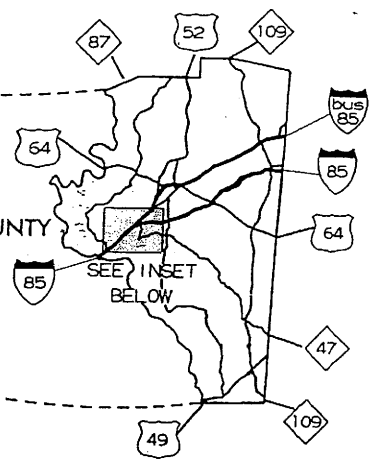

N.C. DEPT. OF TRANSPORTATION
 DIVISION OF HIGHWAYS







DAVIDSON COUNTY

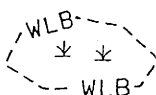
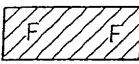
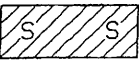

PROJECT: 8.1631403 (I-2304AB)
 I-85 WIDENING FROM JUST NORTH
 OF NC 150 TO JUST NORTH
 OF I-85 BUSINESS

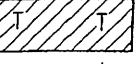
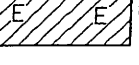
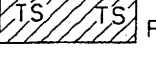
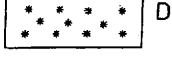
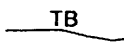
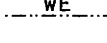
SHEET 1 OF 2

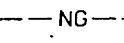

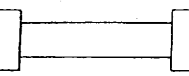
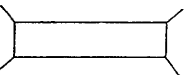

02/24/03

LEGEND

- WLB --- WETLAND BOUNDARY
-  WETLAND
-  DENOTES FILL IN WETLAND
-  DENOTES FILL IN SURFACE WATER
-  DENOTES FILL IN SURFACE WATER (POND)
-  DENOTES TEMPORARY FILL IN WETLAND
-  DENOTES EXCAVATION IN WETLAND
-  DENOTES TEMPORARY FILL IN SURFACE WATER
-  DENOTES MECHANIZED CLEARING
- BZ — RIPARIAN BUFFER ZONE
- ← ← FLOW DIRECTION
-  TOP OF BANK
-  EDGE OF WATER
-  PROP. LIMIT OF CUT
-  PROP. LIMIT OF FILL
-  PROP. RIGHT OF WAY
- NG --- NATURAL GROUND
- PL --- PROPERTY LINE
- TDE — TEMP. DRAINAGE EASEMENT
- PDE — PERMANENT DRAINAGE EASEMENT
- EAB — EXIST. ENDANGERED ANIMAL BOUNDARY
- EPB — EXIST. ENDANGERED PLANT BOUNDARY
- ∇ --- WATER SURFACE
- X X X LIVE STAKES
-  BOULDER
- COIR FIBER ROLLS

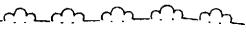
-  PROPOSED BRIDGE
-  PROPOSED BOX CULVERT
-  PROPOSED PIPE CULVERT

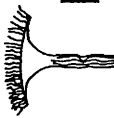
(DASHED LINES DENOTE EXISTING STRUCTURES)

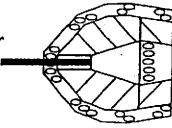
-  SINGLE TREE
-  WOODS LINE
-  DRAINAGE INLET
-  ROOTWAD
-  RIP RAP
-  ADJACENT PROPERTY OWNER OR PARCEL NUMBER IF AVAILABLE
-  RIP RAP ENERGY DISSIPATOR BASIN

N.C. DEPT. OF TRANSPORTATION
DIVISION OF HIGHWAYS

DAVIDSON COUNTY

PROJECT: 8.1631403 (I-2304AB)
I-85 WIDENING FROM JUST NORHT
OF NC 150 TO JUST NORTH
OF I-85 BUSINESS

SHEET **2** OF **21** 2/24/03

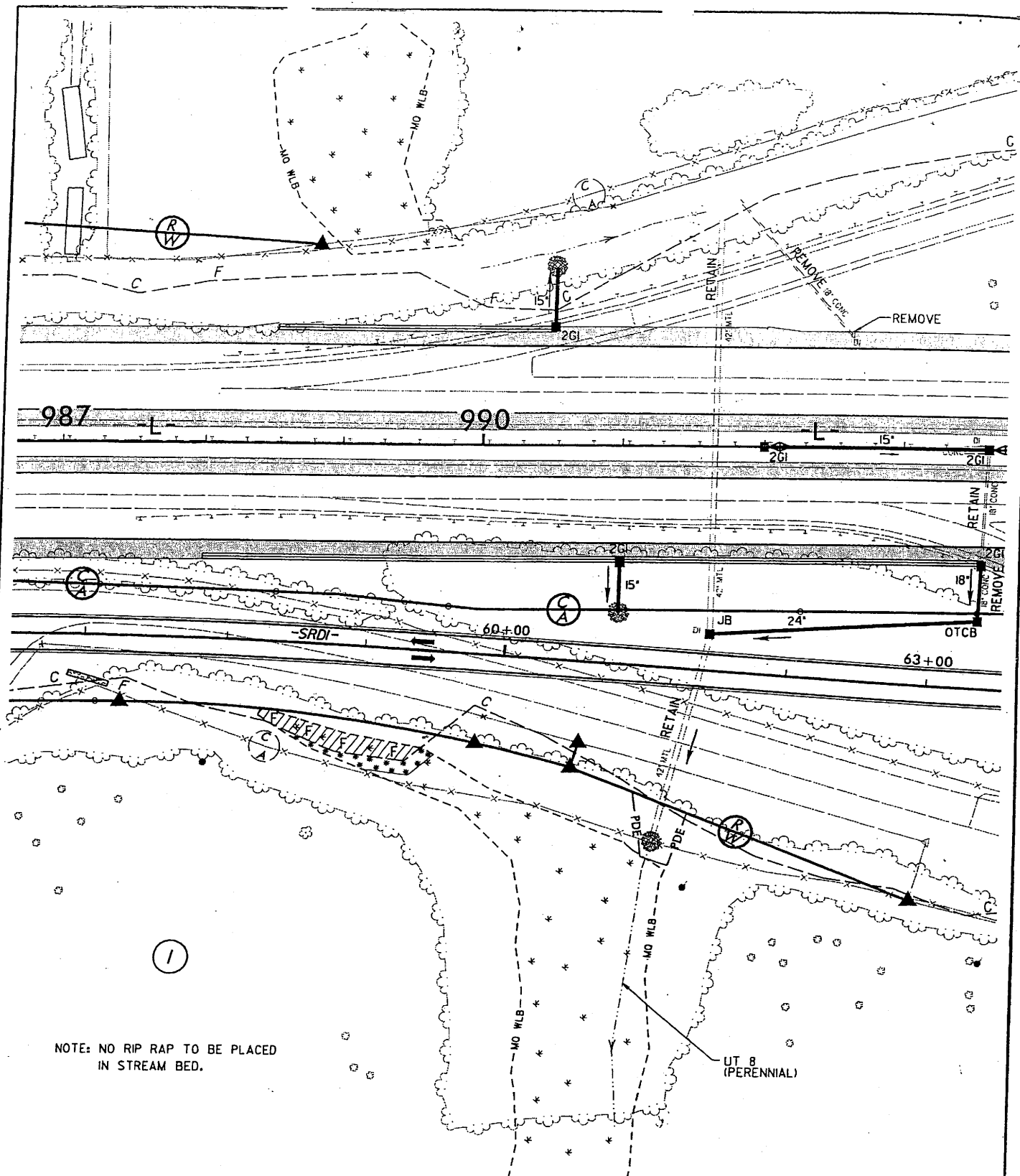

NOTE: NO RIP RAP TO BE PLACED IN STREAM BED.

PLAN VIEW SITE 1

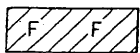

- DENOTES MECHANIZED CLEARING 
- DENOTES FILL IN WETLANDS 

N.C. DEPT. OF TRANSPORTATION
DIVISION OF HIGHWAYS

DAVIDSON COUNTY

PROJECT: 8.1631403 (I-2304AB)
I-85 WIDENING FROM JUST NORTH
OF NC 150 TO JUST NORTH
OF I-85 BUSINESS

SHEET 3 OF 21

2/24/03

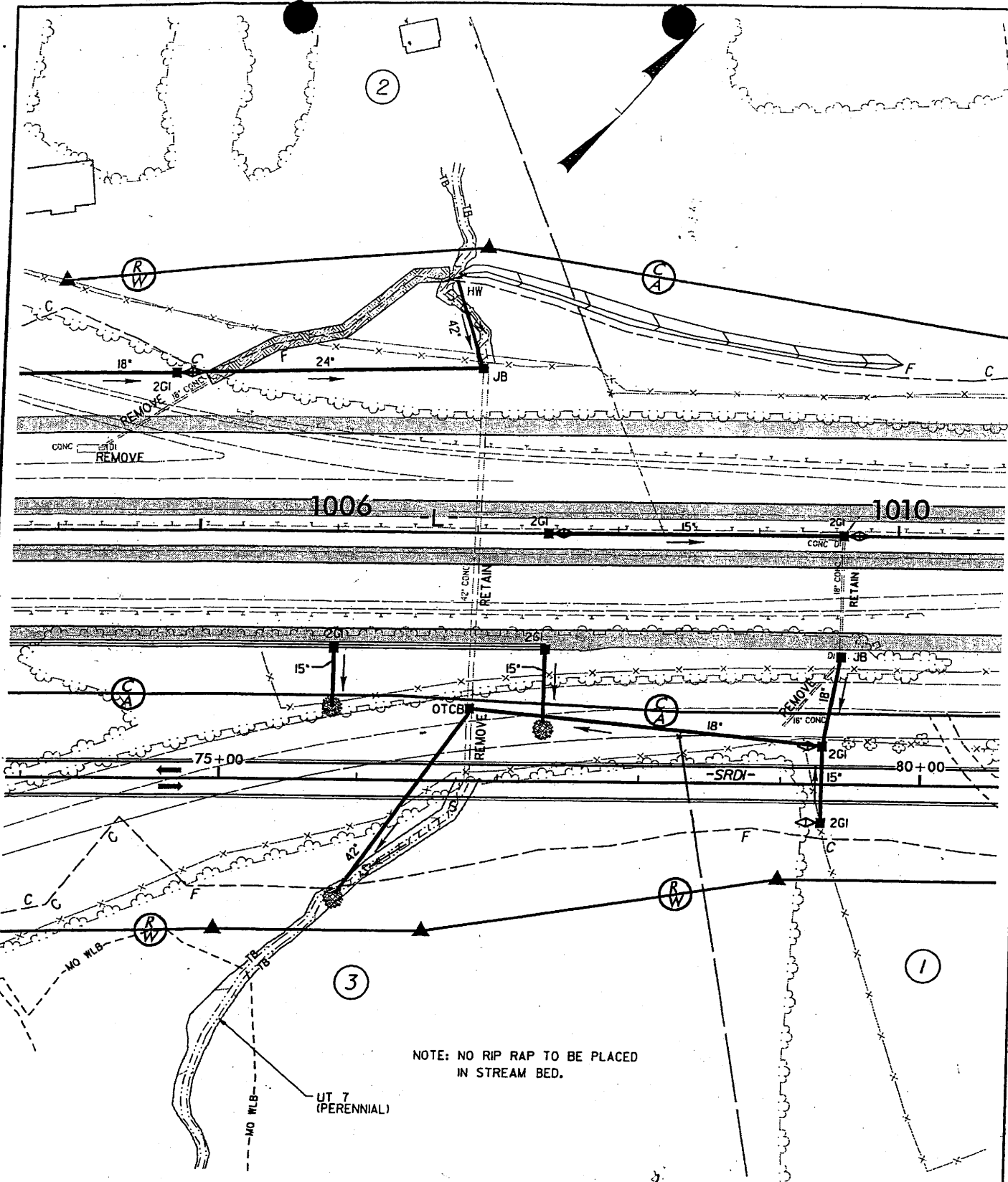

NOTE: NO RIP RAP TO BE PLACED IN STREAM BED.

PLAN VIEW SITE 2

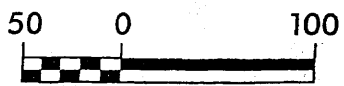

DENOTES FILL IN SURFACE WATERS

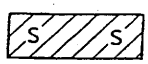

N.C. DEPT. OF TRANSPORTATION
DIVISION OF HIGHWAYS

DAVIDSON COUNTY

PROJECT: 8.1631403 (I-2304AB)
I-85 WIDENING FROM JUST NORTH
OF NC 150 TO JUST NORTH
OF I-85 BUSINESS

SHEET 4 OF 21

2/24/03

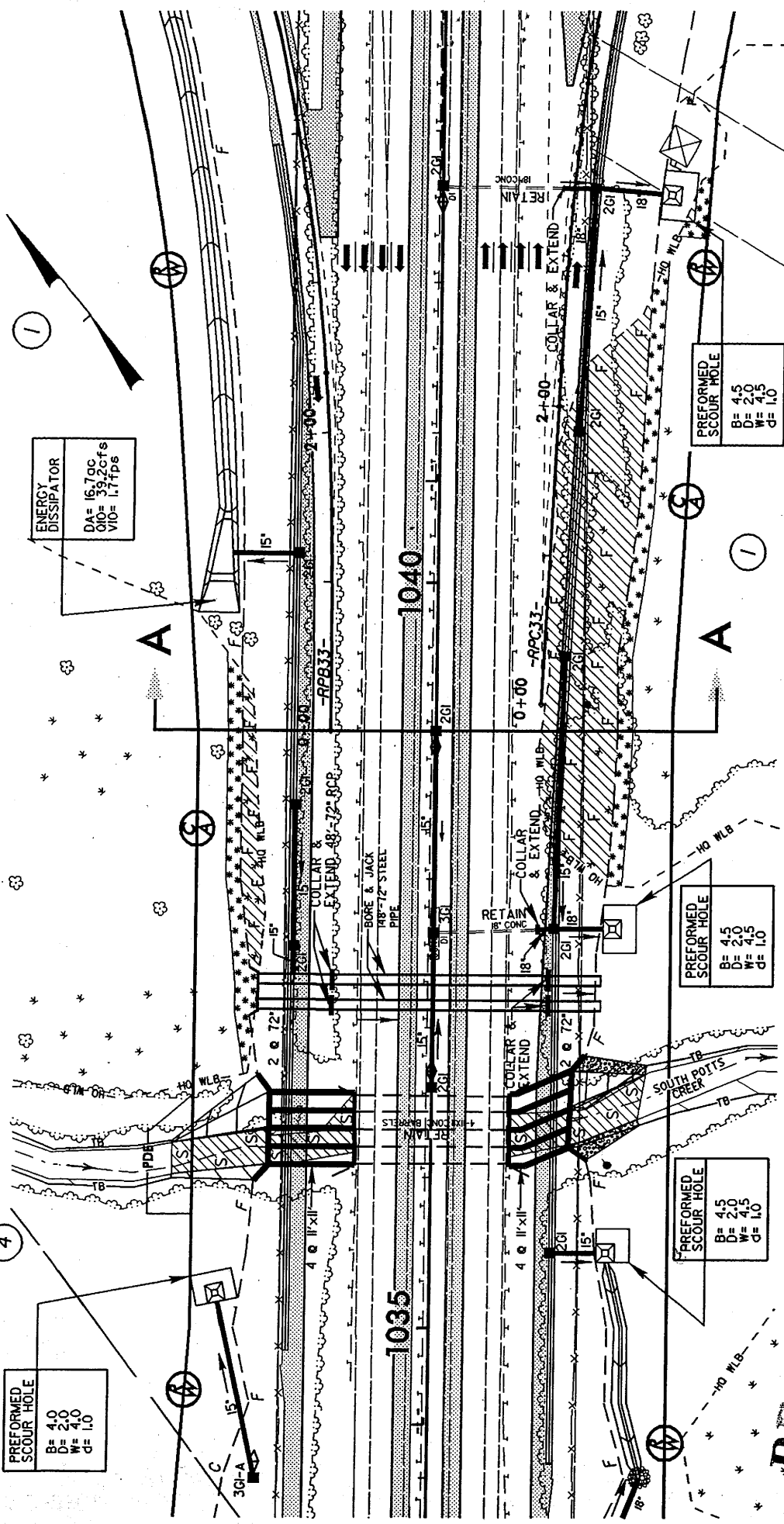

ENERGY DISSIPATOR
 DA= 16.7cc
 O/D= 39.2cfs
 V/D= 1.7f/s

PREFORMED SCOUR HOLE
 B= 4.0
 D= 2.0
 W= 4.0
 C= 1.0

PREFORMED SCOUR HOLE
 B= 4.5
 D= 2.0
 W= 4.5
 C= 1.0

PREFORMED SCOUR HOLE
 B= 4.5
 D= 2.0
 W= 4.5
 C= 1.0

PREFORMED SCOUR HOLE
 B= 4.5
 D= 2.0
 W= 4.5
 C= 1.0

N.C. DEPT. OF TRANSPORTATION
 DIVISION OF HIGHWAYS

DAVIDSON COUNTY
 PROJECT: 8.1631403 (I-2304AB)
 I-85 WIDENING FROM JUST NORTH
 OF NC 150 TO JUST NORTH
 OF I-85 BUSINESS

SHEET 5 OF 21
 2/11/03
 REVISED 3/18/04

PLAN VIEW
 SITE 3

- ***** DENOTES MECHANIZED CLEARING
- ////// DENOTES EXCAVATION IN WETLAND
- ////// DENOTES FILL IN WETLANDS
- ////// DENOTES FILL IN SURFACE WATERS

NOTE: HAND CLEAR IN WETLANDS TO INSTALL CONTROLLED ACCESS FENCING.

RECEIVED 1
 4 2004

RALEIGH REGULATORY FIELD OFFICE



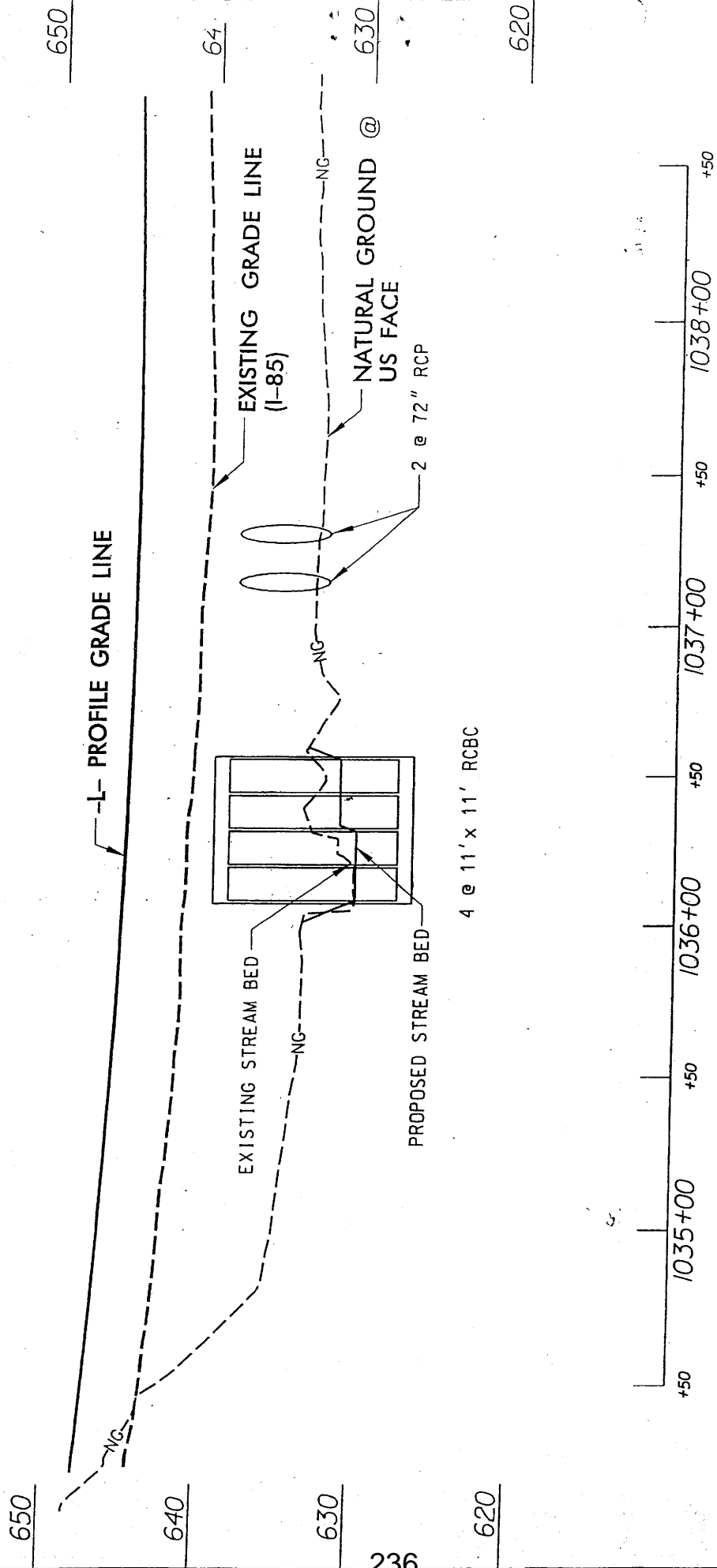

PROFILE SITE 3

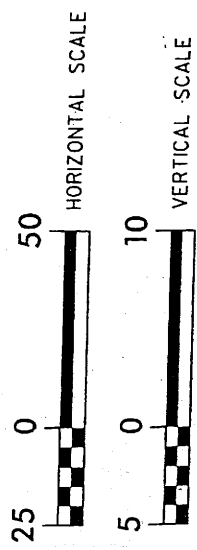

N.C. DEPT. OF TRANSPORTATION
 DIVISION OF HIGHWAYS

DAVIDSON COUNTY

PROJECT: 8.1631403 (I-2504AB)
 I-85 WIDENING FROM JUST NORTH
 OF NC 150 TO JUST NORTH
 OF I-85 BUSINESS

SHEET 2 OF 21

2/24/03

☉ 1039+00 -L-

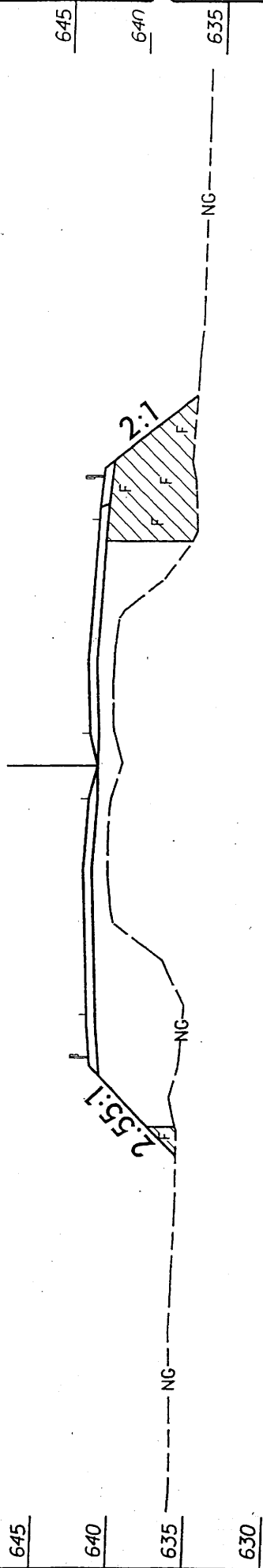

645

640

635

630

645

640

635

630

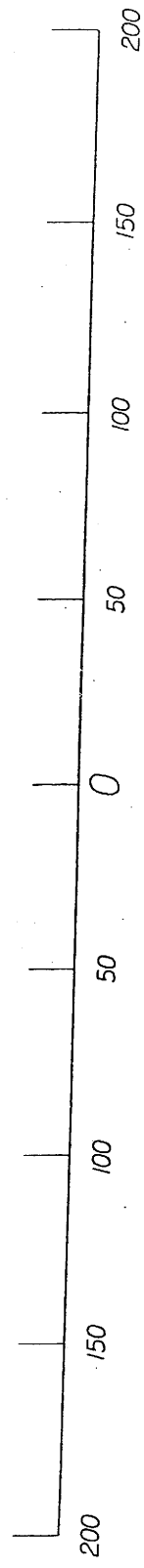

SITE 3
SECTION A-A



DENOTES FILL IN
WETLANDS



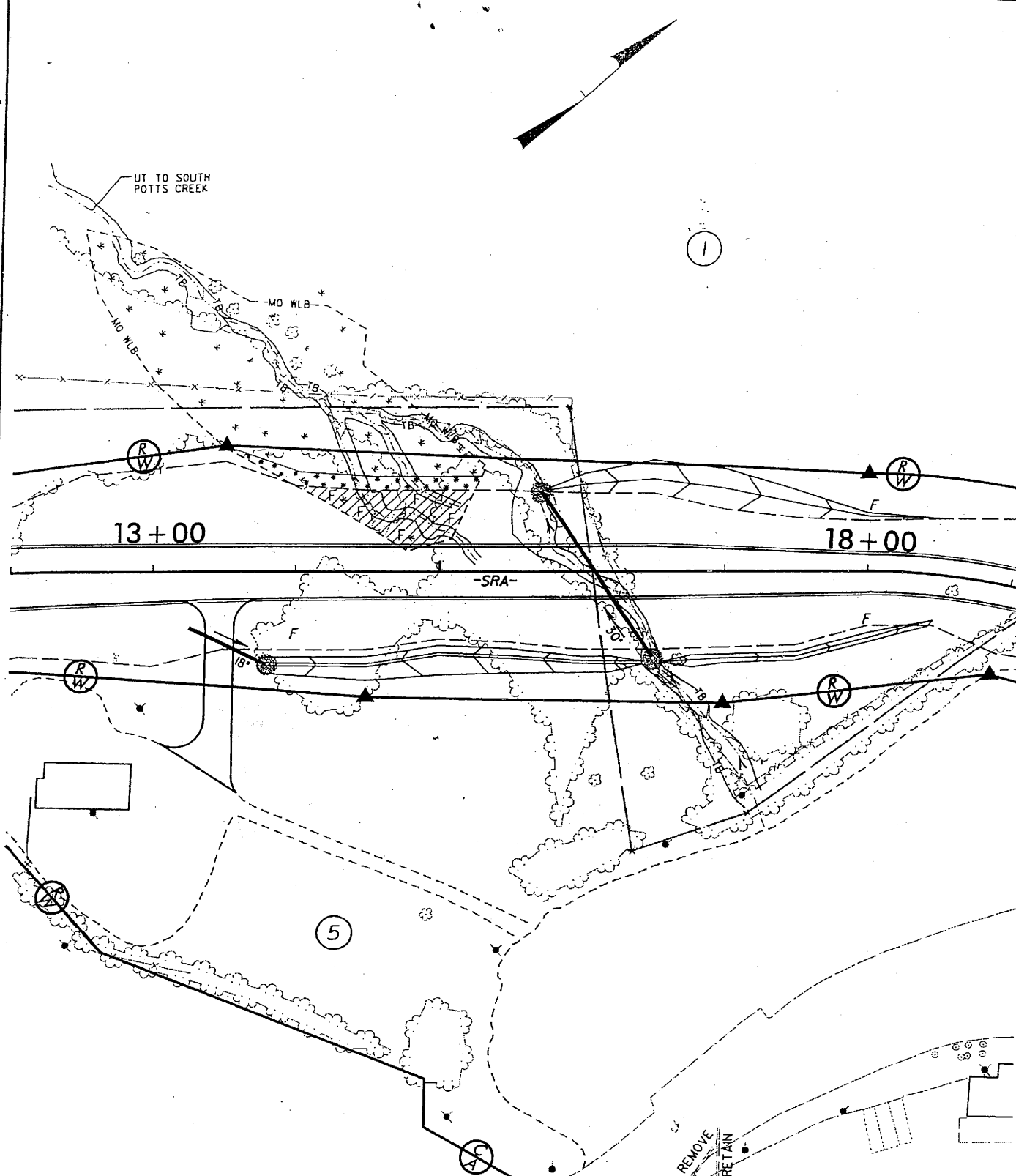

N.C. DEPT. OF TRANSPORTATION
DIVISION OF HIGHWAYS
DAVIDSON COUNTY
PROJECT: 81631403 (I-2304AB)
I-85 WIDENING FROM JUST NORTH
OF NC 150 TO JUST NORTH
OF I-85 BUSINESS
SHEET 7 OF 21

2/24/03

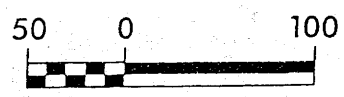

PLAN VIEW
SITE 4



DENOTES MECHANIZED CLEARING 
 DENOTES FILL IN WETLANDS 

238

N.C. DEPT. OF TRANSPORTATION
 DIVISION OF HIGHWAYS
 DAVIDSON COUNTY
 PROJECT: 8.1631403 (I-2304AB)
 I-85 WIDENING FROM JUST NORTH
 OF NC 150 TO JUST NORTH
 OF I-85 BUSINESS
 SHEET 8 OF 21
 2/24/03

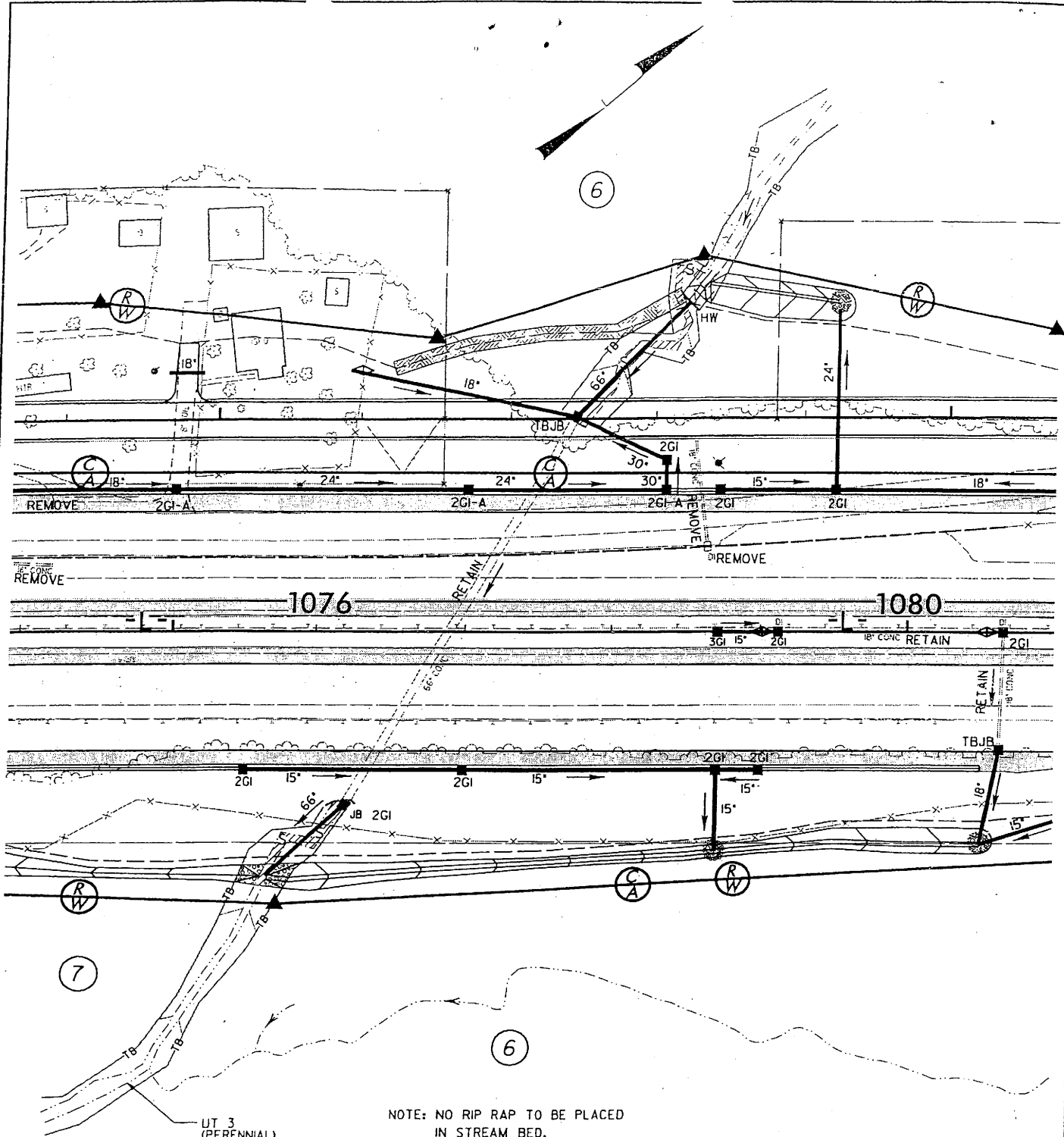

PLAN VIEW
SITE 5

NOTE: NO RIP RAP TO BE PLACED
IN STREAM BED.

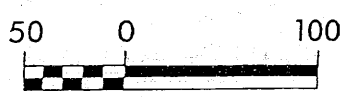

DENOTES FILL IN
SURFACE WATERS



N.C. DEPT. OF TRANSPORTATION
DIVISION OF HIGHWAYS

DAVIDSON COUNTY

PROJECT: 8.1631403 (I-2304AB)
I-85 WIDENING FROM JUST NORTH
OF NC 150 TO JUST NORTH
OF I-85 BUSINESS

SHEET 9 OF 21

2/24/03

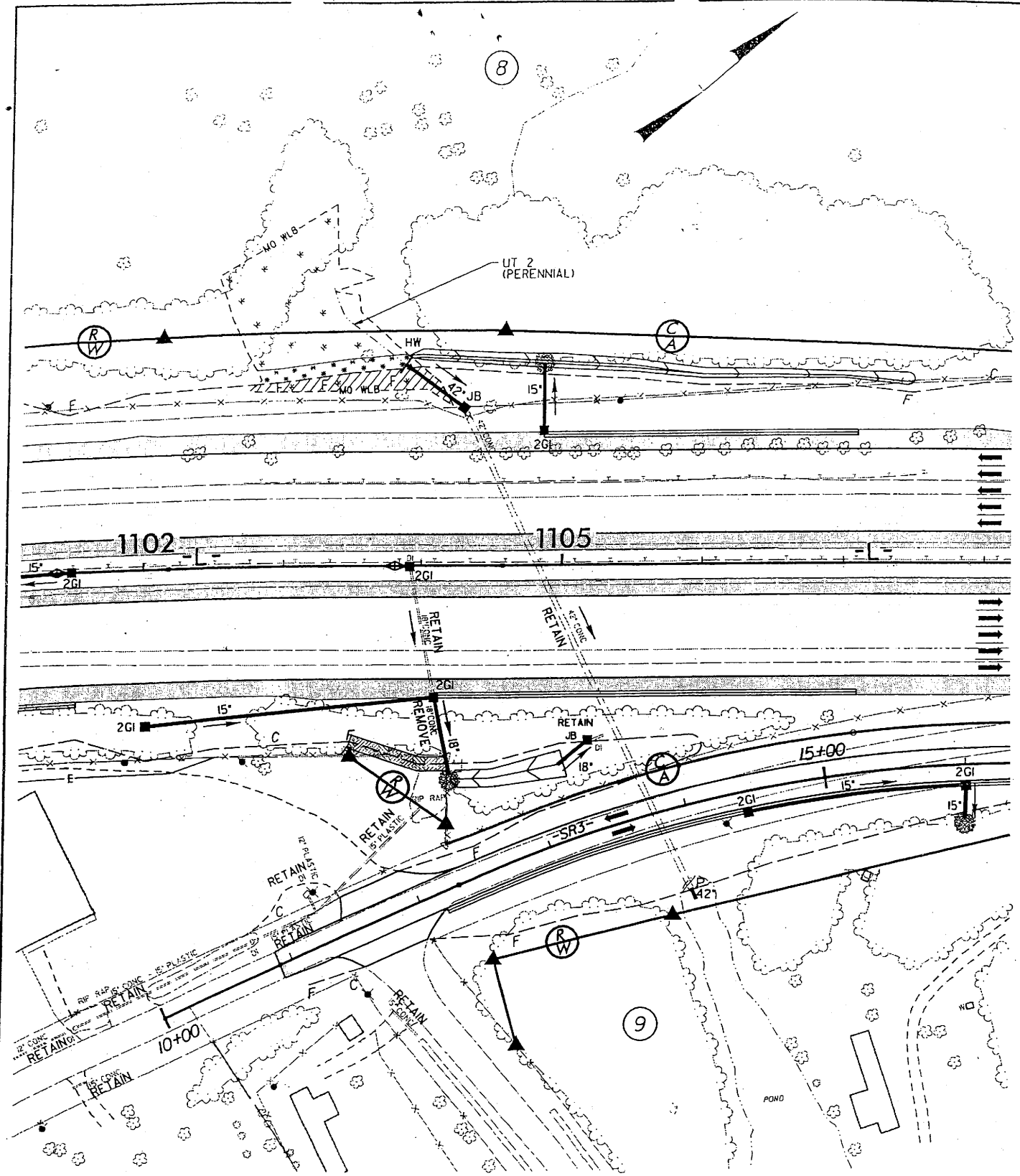

**PLAN VIEW
SITE 6**

NOTE: HAND CLEAR IN WETLANDS TO INSTALL CONTROLLED ACCESS FENCING.

DENOTES MECHANIZED CLEARING

DENOTES FILL IN WETLANDS

DENOTES FILL IN SURFACE WATERS (POND)

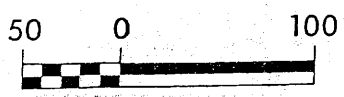
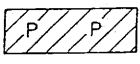
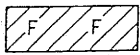

N.C. DEPT. OF TRANSPORTATION
DIVISION OF HIGHWAYS

DAVIDSON COUNTY

PROJECT: 8.1631403 (I-2304AB)
I-85 WIDENING FROM JUST NORTH
OF NC 150 TO JUST NORTH
OF I-85 BUSINESS

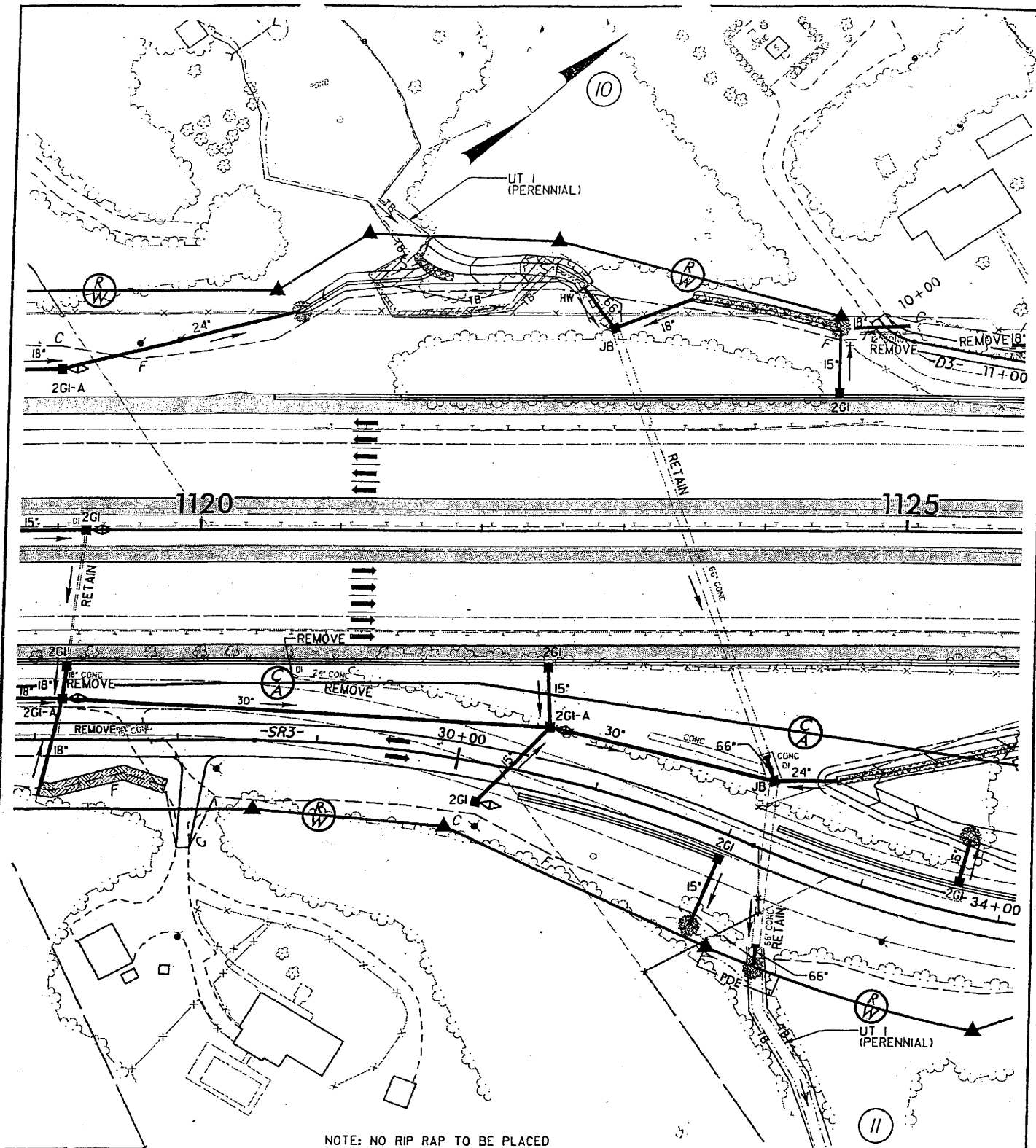

NOTE: NO RIP RAP TO BE PLACED
IN STREAM BED.

PLAN VIEW SITE 7

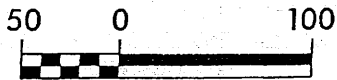

DENOTES FILL IN
SURFACE WATERS

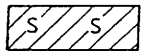

N.C. DEPT. OF TRANSPORTATION
DIVISION OF HIGHWAYS

DAVIDSON COUNTY

PROJECT: 8.1631403 (I-2304AB)
I-85 WIDENING FROM JUST NORTH
OF I-85 BUSINESS

SHEET 11 OF 21

2/24/03

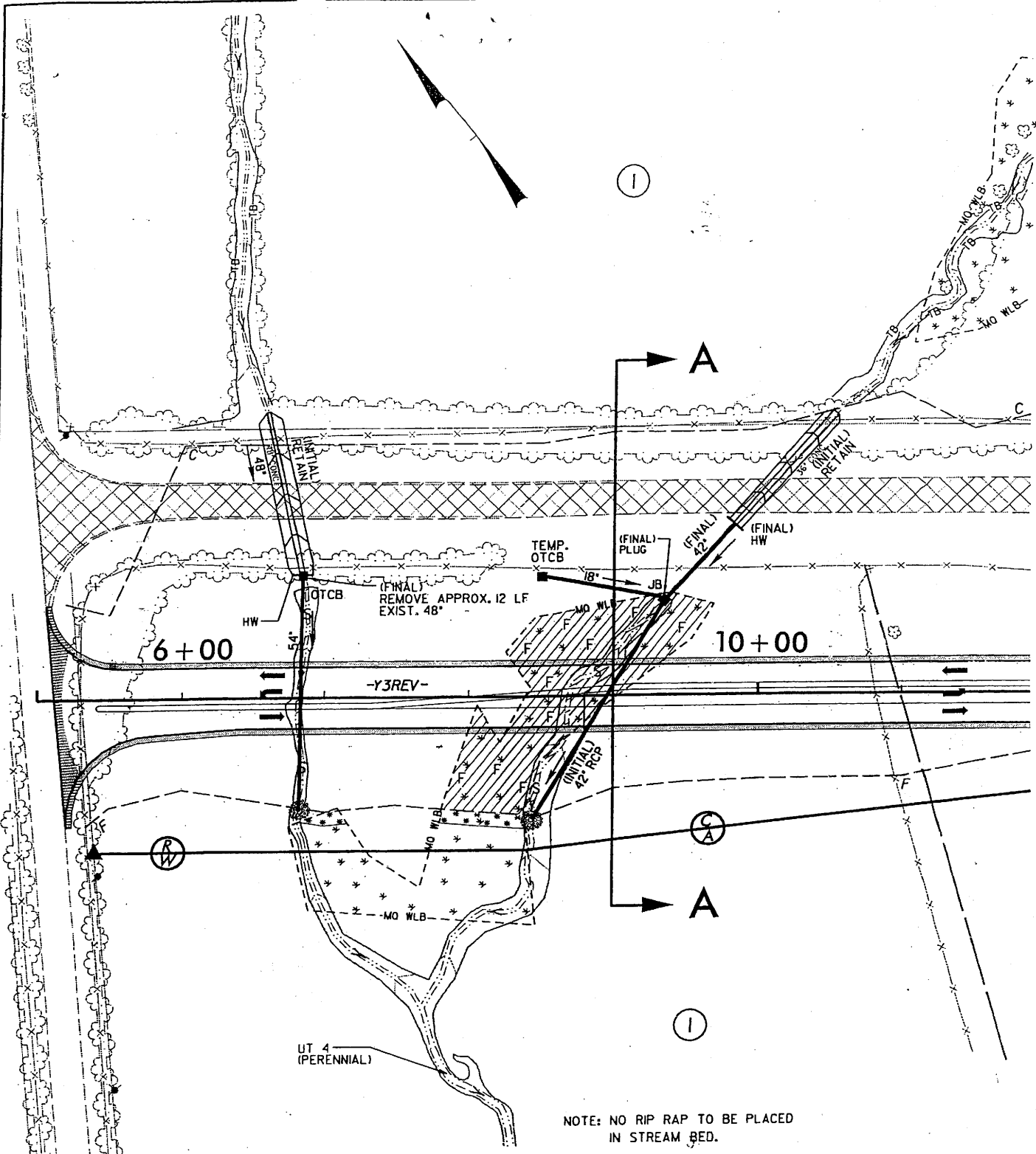

NOTE: NO RIP RAP TO BE PLACED IN STREAM BED.

PLAN VIEW SITE 8

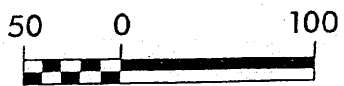

- DENOTES MECHANIZED CLEARING
- DENOTES FILL IN WETLANDS
- DENOTES FILL IN SURFACE WATERS

N.C. DEPT. OF TRANSPORTATION
DIVISION OF HIGHWAYS

DAVIDSON COUNTY

PROJECT: 8.1631403 (I-2304AB)
I-85 WIDENING FROM JUST NORTH
OF NC 150 TO JUST NORTH
OF I-85 BUSINESS

SHEET 12 OF 21 2/24/03

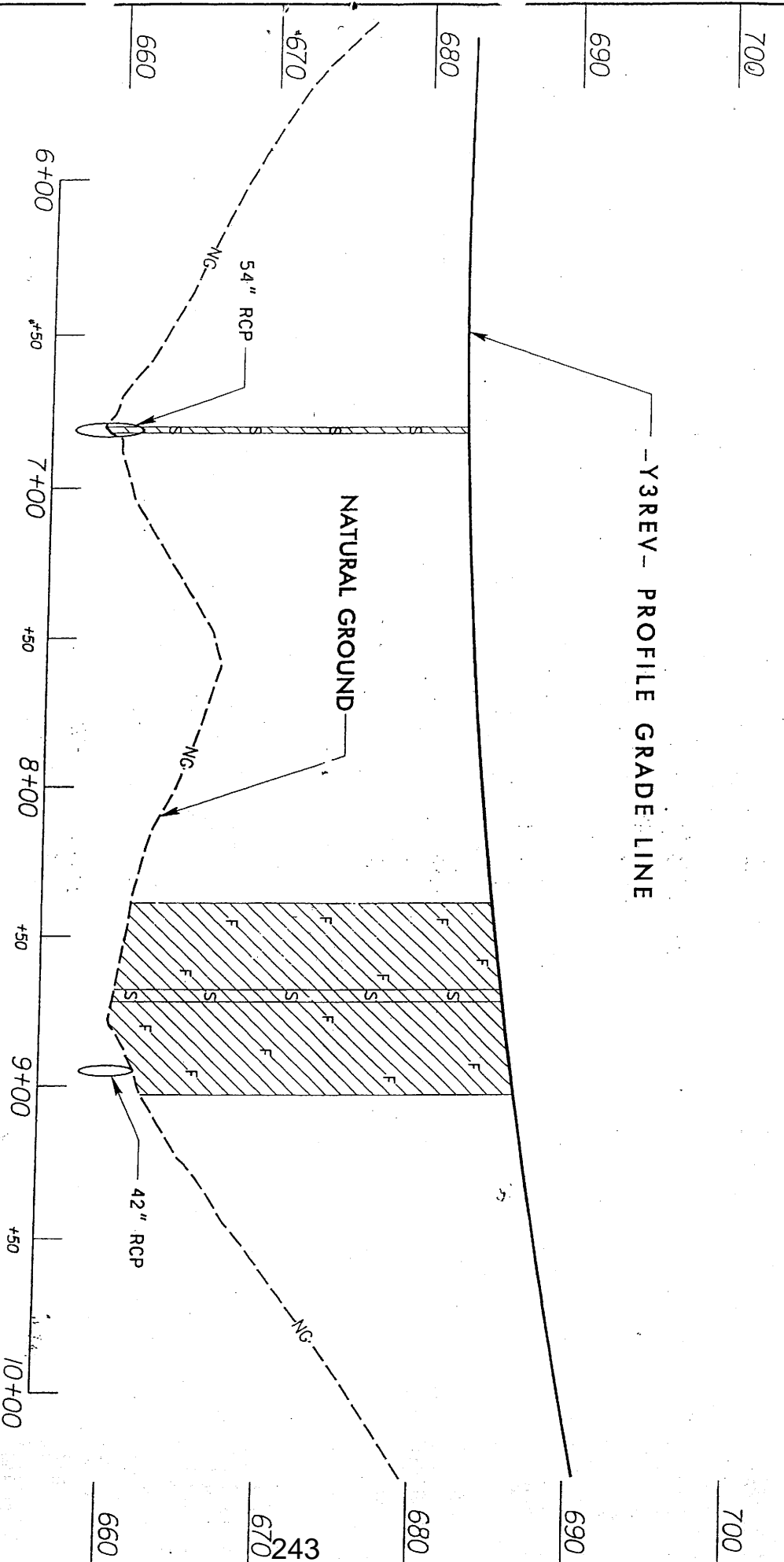

**PROFILE
SITE 8**

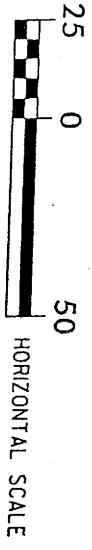

DENOTES FILL IN
SURFACE WATERS

DENOTES FILL IN
WETLANDS

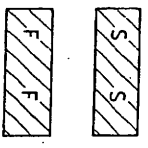

N.C. DEPT. OF TRANSPORTATION
DIVISION OF HIGHWAYS

DAVIDSON COUNTY

PROJECT: 8.1631403 (I-230/4AB)
I-85 WIDENING FROM JUST NORTH
OF NC 150 TO JUST NORTH
OF I-85 BUSINESS

SHEET **13** OF **21**

2/24/03

9 + 00 -Y3REV-

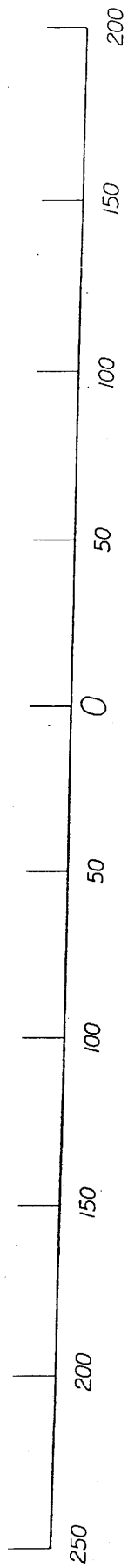
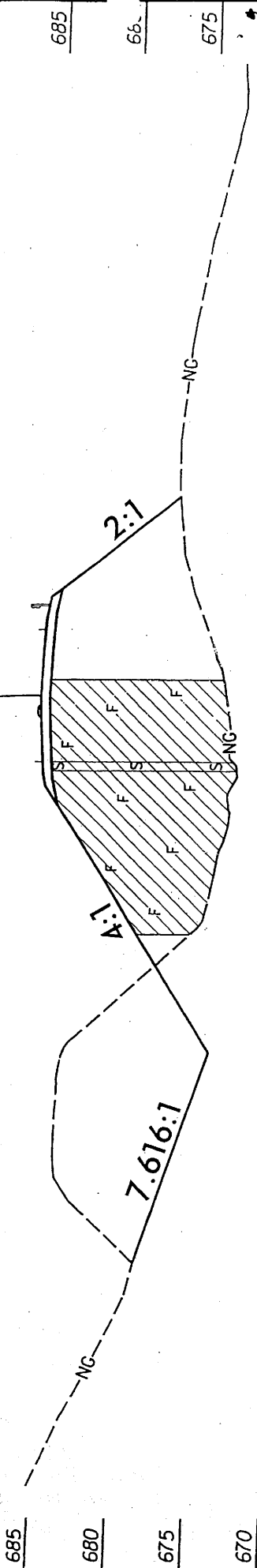

SITE 8
SECTION A-A

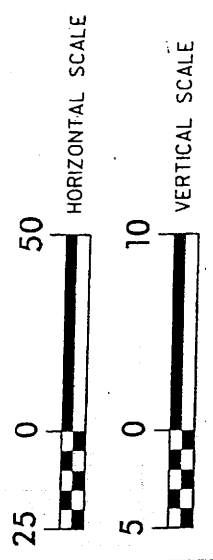

DENOTES FILL IN
SURFACE WATERS

DENOTES FILL IN
WETLANDS

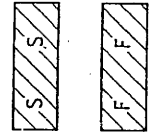

N.C. DEPT. OF TRANSPORTATION
DIVISION OF HIGHWAYS

DAVIDSON COUNTY

PROJECT: 81631403 (I-2304AB)
I-85 WIDENING FROM JUST NORTH
OF NC 150 TO JUST NORTH
OF I-85 BUSINESS

SHEET 14 OF 21

2 / 24 / 03

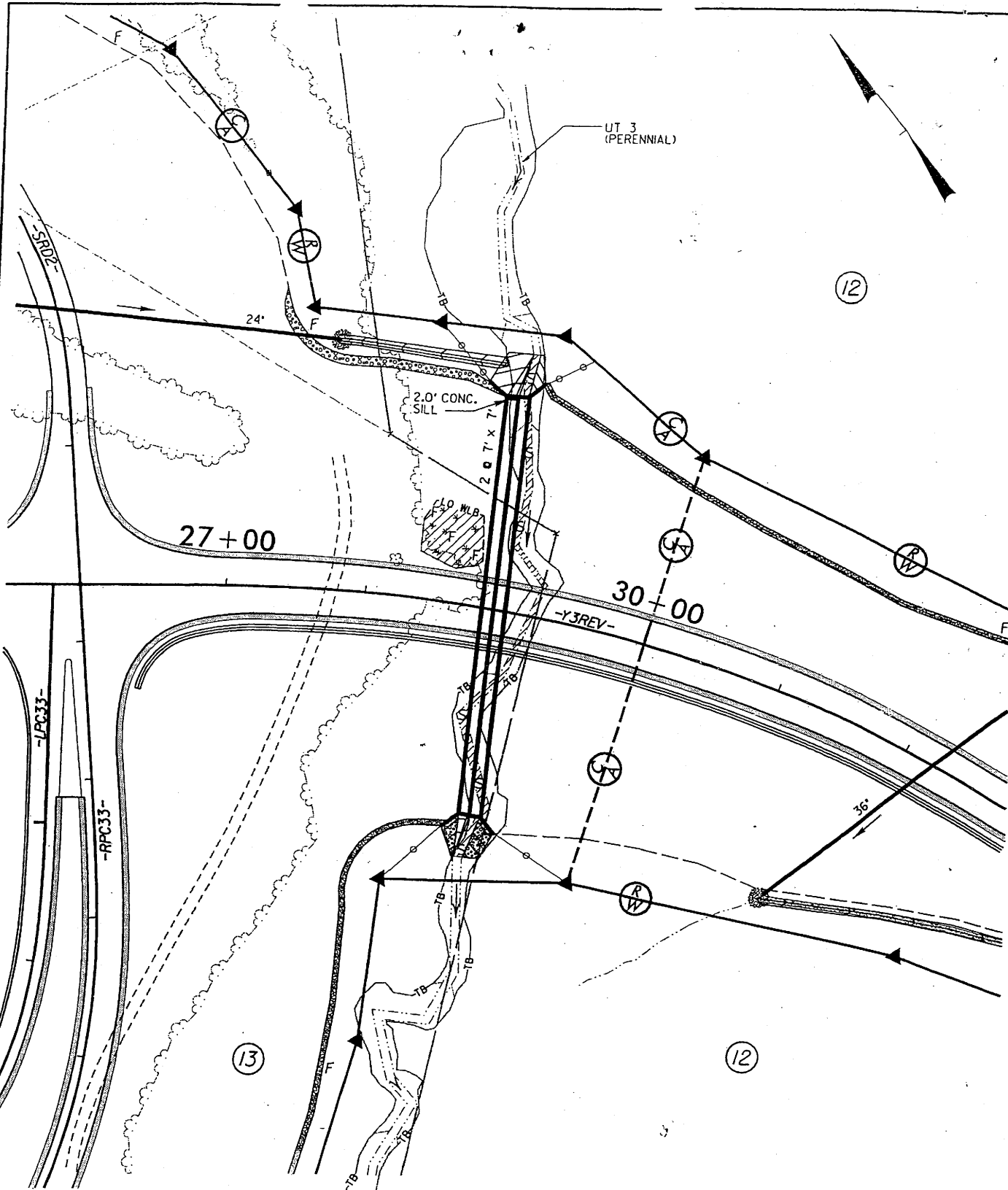

PLAN VIEW
SITE 9



DENOTES FILL IN
WETLANDS



DENOTES FILL IN
SURFACE WATERS



N.C. DEPT. OF TRANSPORTATION
DIVISION OF HIGHWAYS

DAVIDSON COUNTY

PROJECT: 8.1631403 (I-2304AB)
I-85 WIDENING FROM JUST NORTH
OF NC 150 TO JUST NORTH
OF I-85 BUSINESS

SHEET 15 OF 21

2 / 24 / 03

-Y3REV- PROFILE GRADE LINE

(-)2.9360%

720

700

680

246

660

640

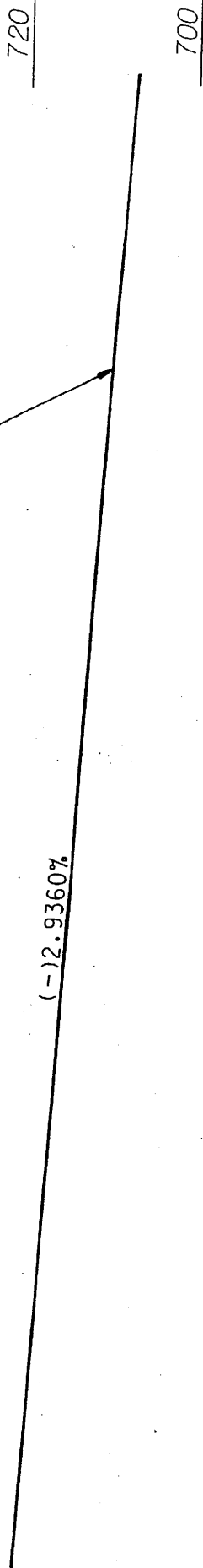

NATURAL GROUND LINE @ US FACE

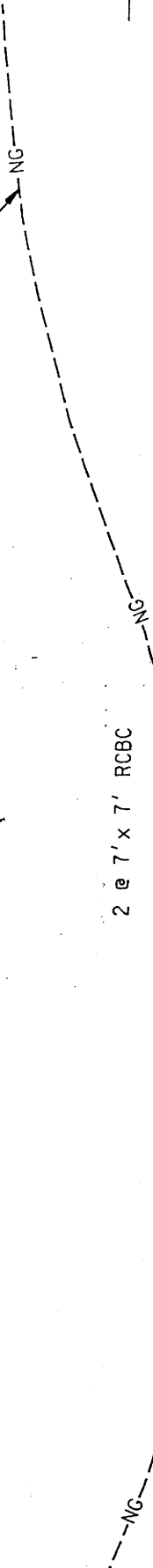

2 @ 7' x 7' RCBC



2'-0" CONC. SILL

PROPOSED STREAM BED

EXISTING STREAM BED

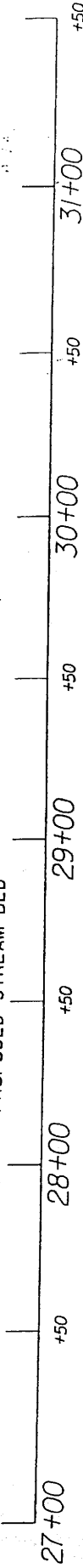

PROFILE SITE 9



N.C. DEPT. OF TRANSPORTATION
DIVISION OF HIGHWAYS

DAVIDSON COUNTY

PROJECT: 8.1651403 (I-2304AB)

I-85 WIDENING FROM JUST NORTH
OF NC 150 TO JUST NORTH
OF I-85 BUSINESS

SHEET 16 OF 21

2/24/03

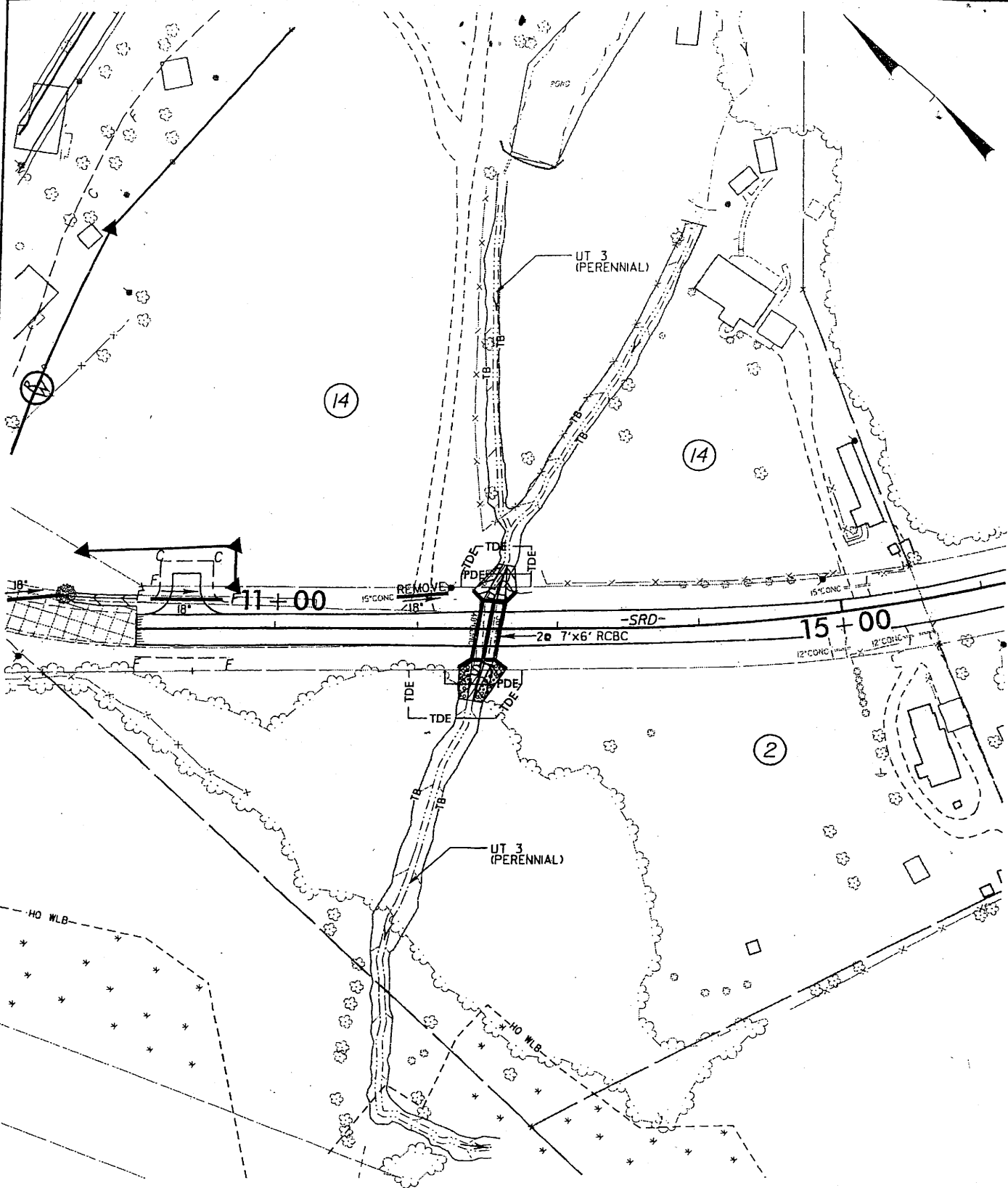

PLAN VIEW
SITE 10



DENOTES FILL IN
SURFACE WATERS



N.C. DEPT. OF TRANSPORTATION
DIVISION OF HIGHWAYS

DAVIDSON COUNTY

PROJECT: 8.1631403 (I-2304AB)
I-85 WIDENING FROM JUST NORTH
OF NC 150 TO JUST NORTH
OF I-85 BUSINESS

SHEET 17 OF 21

2 / 24 / 03

660

650

640

630

620

660

650

640

630

620

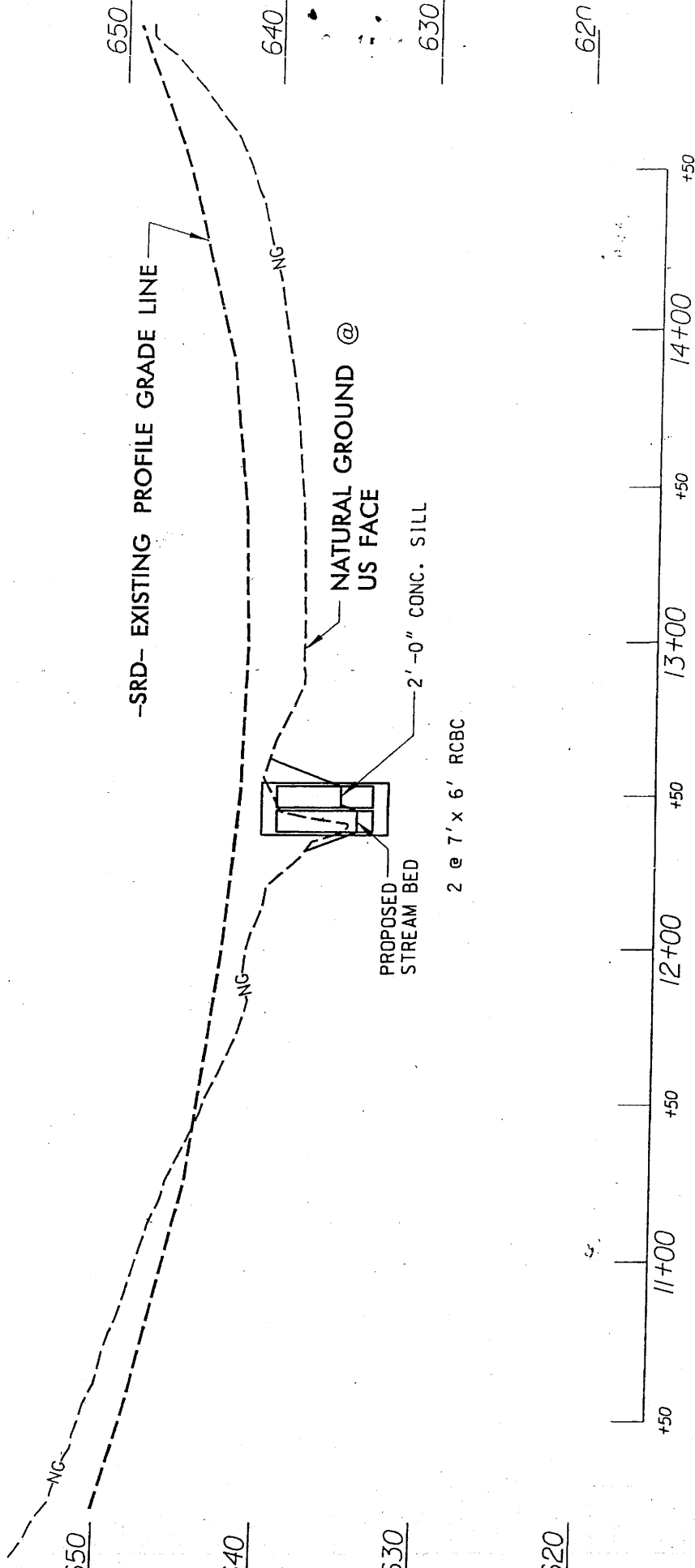

PROFILE SITE 10



N.C. DEPT. OF TRANSPORTATION
DIVISION OF HIGHWAYS

DAVIDSON COUNTY

PROJECT: 8.1631403 (I-2304AB)

I-85 WIDENING FROM JUST NORTH
OF NC 150 TO JUST NORTH

OF I-85 BUSINESS

SHEET 18 OF 24

2/24/03

WETLAND PERMIT IMPACT SUMMARY

Site No.	Station (From / To)	Structure / Type	Size	WETLAND IMPACTS			SURFACE WATER IMPACTS								
				Fill In Wetlands (ac)	Temp. Fill In Wetlands (ac)	Excavation In Wetlands (ac)	Mechanized Clearing (Method III) (ac)	Fill In SW (Natural) (ac)	Fill In SW (Pond) (ac)	Temp. Fill In SW (ac)	Existing Channel Impacted (ft)	Natural Stream Design (ft)			
1	-L- 988+45R / -L- 989+70R			0.033			0.019								
2	-L- 1006+08R / -L- 1007+00L	1 @ 42" RCP						0.021					219		
3	-L- 1036+00 / -L- 1042+70R	4 @ 11" x 11" RCBC w/ 2 @ 72"		0.463		0.016	0.171	0.062					216		
4	-SRA- 13+50L / -SRA- 16+70R	1 @ 30" RCP		0.071			0.036								
5	-L- 1076+70R / -L- 1078+70R	1 @ 66" RCP													
6	-L- 1102+75L / -L- 1106+10R	1 @ 42" RCP		0.037			0.026	0.034					270		
7	-L- 1121+15L / -L- 1124+05R	1 @ 66" RCP							0.003						
8	-Y3REV- 6+50R / -Y3REV- 6+92L -Y3REV- 7+80R / -Y3REV- 9+70R	1 @ 54" RCP 1 @ 42" RCP		0.263			0.005 0.003	0.009 0.014					179 201		
9	-Y3REV- 28+65L / -Y3REV- 29+35R	2 @ 7' x 7' RCBC w/ 2' CONC. SILL		0.039				0.042					395		
10	-SRD- 12+26R / -SRD- 12+78L	2 @ 7' x 6' RCBC w/ 2' CONC. SILL						0.006					59		
TOTALS:				0.906	0.000	0.016	0.266	0.218	0.003	0.000	1811	0			

N.C. DEPARTMENT OF TRANSPORTATION
 DIVISION OF HIGHWAYS

 DAVIDSON COUNTY

 PROJECT 8.1631403 (I-2304AB)
 I-85 WIDENING FROM JUST NORTH
 OF NC 150 TO JUST NORTH OF
 I-85 BUSINESS

Property Owner List

Site NO.	Parcel NO.	Name DB and Pg	Address
1	①	Robert L. Grubb Trustee of June C. Little DB 698 Pg 336	P.O. BOX 388 High Point, NC 27260
2	①	Robert L. Grubb Trustee of June C. Little DB 698 Pg 336	P.O. BOX 388 High Point, NC 27260
	②	Franklin Haywood Graves And Wife, Margaret L Graves DB 635 Pg 17 DB 915 Pg 965 DB 401 Pg 338	8291 Old Salisbury Road Linwood, NC 27299-9708
	③	Everhart Used Cars, Inc. DB 635 Pg 161	1517 Greensboro Road Lexington NC 27292-1919
3	①	Robert L. Grubb Trustee of June C. Little DB 699 Pg 336	P.O. BOX 388 High Point, NC 27260
	④	Earl L Blanton And Wife, Kathy L Blanton DB 705 Pg 514	7847 Old Salisbury Road Linwood, NC 27299
4	①	Robert L. Grubb Trustee of June C. Little DB 699 Pg 336	P.O. BOX 388 High Point, NC 27260
	⑤	Walser Enterprises DB 112 Pg 110	Snider-Kines Road Linwood, NC 27299
5	⑥	C. C. Fitzgerald Heirs DB 57 Pg 205	194 Redwine Road Linwood, NC 27299
	⑦	Randall G Lomax And Wife, Tammy P Lomax DB 875 Pg 936	310 Lake Shore Drive Lexington, NC 27292-8117

N.C. DEPT. OF TRANSPORTATION
 DIVISION OF HIGHWAYS
 DAVIDSON COUNTY
 PROJECT: 8.1631403 (I-2304AB)
 I-85 WIDENING FROM JUST NORTH
 OF NC 150 TO JUST NORTH
 OF I-85 BUSINESS
 SHEET 20 OF 21 2/24/03

Property Owner List

Site NO.	Parcel NO.	Name DB and Pg	Address
6	8	Mobile Development Corp. DB 1051 Pg 1588	23 West Second Street Lexington, NC 27292
	9	Robert A. Gusman DB 634 Pg 656 DB 613 Pg 959	P.O. Box 992 Lexington, NC 27293-0992
7	10	George W Gobble And Wife, Betty E Gobble DB 596 Pg 757	984 Wayane Gobble Road Linwood, NC 27299-9706
	11	Margaret N. Clark DB 832 Pg 814	1089 Clyde Fitzgerald Road Linwood, NC 27299
8	1	Robert L. Grubb Trustee of June C. Little DB 699 Pg 336	P.O. BOX 388 High Point, NC 27260
9	12	Beallmont Farms Inc. DB 931 Pg 628	P.O. Box 835 Linwood, NC 27299
	13	Henderson Hargrave Heirs DB 102 Pg 288	561 Belmont Road Linwood, NC 27299-9201
10	2	Walter McDowell, SR DB 550 Pg 769	796 Belmont Road Linwood, NC 27299-9201
	14	Henderson Hargrave Heirs DB 102 Pg 288	561 Belmont Road Linwood, NC 27299-9201

N.C. DEPT. OF TRANSPORTATION
 DIVISION OF HIGHWAYS
 DAVIDSON COUNTY
 PROJECT: 8.1631403 (I-2304AB)
 I-85 WIDENING FROM JUST NORHT
 OF NC 150 TO JUST NORTH
 OF I-85 BUSINESS
 SHEET 21 OF 21 2/24/03



REPLY TO
ATTENTION OF:

DEPARTMENT OF THE ARMY
WILMINGTON DISTRICT, CORPS OF ENGINEERS
69 DARLINGTON AVENUE
WILMINGTON, NORTH CAROLINA 28403-1343

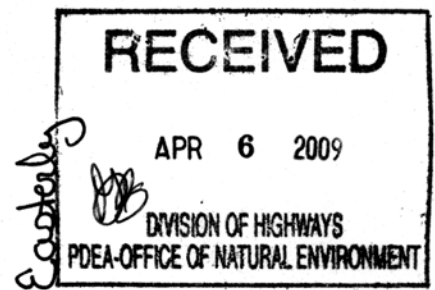

April 1, 2009

Regulatory Division

Action ID. 199821203; TIP No. I-239⁹4A

Dr. Gregory J. Thorpe, Ph.D.
Environmental Management Director, PDEA
N.C. Department of Transportation
1598 Mail Service Center
Raleigh, North Carolina 27699-1598

Dear Dr. Thorpe:

Reference is made to your Department of the Army (DA) permit issued on December 16, 2004, authorizing the discharge of fill material into waters of the United States (jurisdictional waters) for construction of Section A of the Interstate 85 (I-85) Improvements (T.I.P. No. I-2304A), from north of SR 2120 (Exit 81), northeast of Spence, in Rowan County, to north of I-85 Business (Exit 87), southwest of Lexington, in Davidson County, North Carolina. The project is adjacent to jurisdictional waters of the Yadkin River, Potts Creek, and unnamed tributaries of the Yadkin River.

Reference is also made to your written request of February 20, 2009, to extend your DA permit. As stated in your request the project was scheduled to start construction in 2004; however, funding for the project was cut and construction of the project was never started. At this time, new funding for the project is anticipated and the NCDOT plans to proceed with construction. The current DA permit for the project has an expiration date of December 31, 2009. It is expected that the project including the replacement and demolition of several bridges will take four years to complete. Therefore, you have requested a four year extension of your current DA permit. In accordance with your request, your permit is hereby extended until December 31, 2013. All other conditions of the original permit remain in full force and effect.

If the permitted work is not completed on or before the date herein specified, the authorization, if not previously revoked or specifically further extended, will cease and become null and void. If additional time is required to complete the project, you should contact this office with a request for an additional time extension.

Should you have questions, please contact Mr. John Thomas, Raleigh Regulatory Field Office, telephone (919) 554-4884 extension 25.

Sincerely,

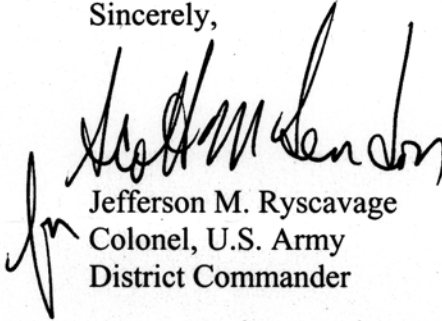

Jefferson M. Ryscavage
Colonel, U.S. Army
District Commander

Copies furnished:

Mr. Brian Wrenn
Division of Water Quality
North Carolina Department of Environment
and Natural Resources
1650 Mail Service Center
Raleigh, North Carolina 27699-1650

Mr. Travis Wilson
Eastern Region Highway Project Coordinator
Habitat Conservation Program
1142 I-85 Service Road
Creedmoor, North Carolina 27522

Mr. Pete Benjamin
U.S. Fish and Wildlife Service
Fish and Wildlife Enhancement
Post Office Box 33726
Raleigh, North Carolina 27636-3726

Mr. Chris Militscher
C/O FHWA
U.S. Environmental Protection Agency
Raleigh Office
310 New Bern Avenue, Room 206
Raleigh, North Carolina 27601

***** STANDARD SPECIAL PROVISIONS *****

LIABILITY INSURANCE

(11-18-08)

DB1 G80

Revise the 2006 Standard Specifications as follows:

Page 1-68, Article 107-16 is amended to include the following as the first, second, third and fourth paragraphs:

The Design-Build Team shall be liable for any losses resulting from a breach of the terms of this contract. The Design-Build Team shall be liable for any losses due to the negligence or willful misconduct of its agents, assigns and employees including any sub-contractors which causes damage to others for which the Department is found liable under the Torts Claims Act, or in the General Courts of Justice, provided the Department provides prompt notice to the Design-Build Team and that the Design-Build Team has an opportunity to defend against such claims. The Design-Build Team shall not be responsible for punitive damages.

The Design-Build Team shall at its sole cost and expense obtain and furnish to the Department an original standard ACORD form certificate of insurance evidencing commercial general liability with a limit for bodily injury and property damage in the amount of \$5,000,000.00 per occurrence and general aggregate, covering the Design-Build Team from claims or damages for bodily injury, personal injury, or for property damages which may arise from operating under the contract by the employees and agents of the Design-Build Team. The required limit of insurance may be obtained by a single general liability policy or the combination of a general liability and excess liability or umbrella policy. The State of North Carolina shall be named as an additional insured on this commercial general liability policy. The policy may contain the following language as relates to the State as an additional insured: "This insurance with respect to the additional insured applies only to the extent that the additional insured is held liable for your or your agent's acts or omissions arising out of and in the course of operations performed for the additional insured."

The Design-Build Team shall maintain all legally required insurance coverage, including without limitation, worker's compensation and vehicle liability, in the amounts required by law. Providing and maintaining adequate insurance coverage is a material obligation of the Design-Build Team and is of the essence of this contract. All such insurance shall meet all laws of the State of North Carolina. Such insurance coverage shall be obtained from companies that are authorized to provide such coverage and that are authorized by the Commissioner of Insurance to do business in North Carolina. The Design-Build Team shall at all times comply with the terms of such insurance policies.

Upon execution of the contract, provide evidence of the above insurance requirements to the Engineer.

PLANT AND PEST QUARANTINES

(Imported Fire Ant, Gypsy Moth, Witchweed, And Other Noxious Weeds)

(3-18-03)

DB1 G130

Within Quarantined Area

This project may be within a county regulated for plant and / or pests. If the project or any part of the Design-Build Team's operations is located within a quarantined area, thoroughly clean all equipment prior to moving out of the quarantined area. Comply with federal/state regulations by obtaining a certificate or limited permit for any regulated article moving from the quarantined area.

Originating in a Quarantined County

Obtain a certificate or limited permit issued by the N.C. Department of Agriculture / United States Department of Agriculture. Have the certificate or limited permit accompany the article when it arrives at the project site.

Contact

Contact the N.C. Department of Agriculture / United States Department of Agriculture at 1-800-206-9333, 919-733-6932, or <http://www.ncagr.com/plantind/> to determine those specific project sites located in the quarantined area or for any regulated article used on this project originating in a quarantined county.

Regulated Articles Include

1. Soil, sand, gravel, compost, peat, humus, muck, and decomposed manure, separately or with other articles. This includes movement of articles listed above that may be associated with cut / waste, ditch pulling, and shoulder cutting.
2. Plants with roots including grass sod.
3. Plant crowns and roots.
4. Bulbs, corms, rhizomes, and tubers of ornamental plants.
5. Hay, straw, fodder, and plant litter of any kind.
6. Clearing and grubbing debris.
7. Used agricultural cultivating and harvesting equipment.
8. Used earth-moving equipment.
9. Any other products, articles, or means of conveyance, of any character, if determined by an inspector to present a hazard of spreading imported fire ant, gypsy moth, witchweed or other noxious weeds.

CONTRACTOR CLAIM SUBMITTAL FORM

(9-16-08)

DB1 G140

If the Design-Build Team elects to file a written claim or requests an extension of contract time, it shall be submitted on the *Contractor Claim Submittal Form (CCSF)* available through the Construction Unit or

http://ncdot.org/doh/operations/dp_chief_eng/constructionunit/formsmanuals/.

GIFTS FROM VENDORS AND CONTRACTORS:

(12-15-09)

DB1 G152

By Executive Order 24, issued by Governor Perdue, and *N.C. G.S. § 133-32*, it is unlawful for any vendor or contractor (i.e. architect, bidder, contractor, construction manager, design professional, engineer, landlord, offeror, seller, subcontractor, supplier, or vendor), to make gifts or to give favors to any State employee of the Governor's Cabinet Agencies (i.e. Administration, Commerce, Correction, Crime Control and Public Safety, Cultural Resources, Environment and Natural Resources, Health and Human Services, Juvenile Justice and Delinquency Prevention, Revenue, Transportation, and the Office of the Governor). This prohibition covers those vendors and contractors who:

- (1) have a contract with a governmental agency; or
- (2) have performed under such a contract within the past year; or
- (3) anticipate bidding on such a contract in the future.

For additional information regarding the specific requirements and exemptions, vendors and contractors are encouraged to review Executive Order 24 and *G.S. § 133-32*.

Executive Order 24 also encouraged and invited other State Agencies to implement the requirements and prohibitions of the Executive Order to their agencies. Vendors and contractors should contact other State Agencies to determine if those agencies have adopted Executive Order 24.

EMBANKMENTS

(5-16-06) (Rev 7-21-09)

DB2 R018

Revise the *Standard Specifications* as follows:

Page 2-22, Article 235-3 Materials, add the following as the second sentence of the second paragraph:

Aerate and dry material containing moisture content in excess of what is required to achieve embankment stability and specified density.

Page 2-22, Subarticle 235-4(B) Embankment Formation, add the following:

- (16) Do not place rock or broken pavement in embankment areas where piles or drilled shaft foundations are to be constructed. This shall include but not be limited to piles and foundations for structures, metal signal poles, overhead sign structures, and high mount lighting.

SHALLOW UNDERCUT

(9-18-07)

DB2 R35

Description

Perform undercut excavation and place a combination of fabric for soil stabilization and Class IV Subgrade Stabilization at locations as directed. Work includes performing undercut excavation, disposing of unsuitable material, furnishing and placing fabric for soil stabilization; and furnishing, placing and compacting Class IV Subgrade Stabilization.

Materials

Refer to Division 10 of the 2006 *Standard Specifications for Roads and Structures*:

Item	Section
Select Material, Class IV	1016
Fabric for Soil Stabilization, Type 4	1056

Use Class IV Select Material for Class IV Subgrade Stabilization. If Class IV Subgrade Stabilization does not meet the requirements of Article 1010-2 of the 2006 *Standard Specifications for Roads and Structures*, the Engineer, at his discretion, may consider the material reasonably acceptable in accordance with Article 105-3 of the 2006 *Standard Specifications for Roads and Structures*.

Construction Methods

Perform undercut excavation in accordance with Section 225 of the 2006 *Standard Specifications for Roads and Structures*. Place fabric for soil stabilization in accordance with Article 270-3 of the 2006 *Standard Specifications for Roads and Structures* before backfilling. Backfill with Class IV Subgrade Stabilization by end dumping subgrade stabilization material on the fabric. Do not operate heavy equipment on the fabric until it is covered with Class IV Subgrade Stabilization. Compact subgrade stabilization material to 92% of AASHTO T180 as modified by the Department or to the highest density that can be reasonably obtained.

Maintain Class IV Subgrade Stabilization in an acceptable condition and minimize the use of heavy equipment on subgrade stabilization material in order to avoid damaging the backfill. Provide and maintain drainage ditches and drains as required to prevent entrapment of water in backfill.

FLOWABLE FILL

(8-21-07)

DB3 R30

Description

This work consists of all work necessary to place flowable fill in accordance with these provisions, the plans developed by the Design-Build Team, and as directed.

Materials

Provide flowable fill material in accordance with Article 340-2 of the 2006 *Standard Specifications for Roads and Structures*.

Construction Methods

Discharge flowable fill material directly from the truck into the space to be filled, or by other approved methods. The mix may be placed full depth or in lifts as site conditions dictate. The Design-Build Team shall provide a method to plug the ends of the existing pipe in order to contain the flowable fill.

REINFORCED BRIDGE APPROACH FILL

7-18-06

DB4 R 01

Description

This work consists of all work necessary to construct reinforced bridge approach fills in accordance with these provisions and the plans, and as directed by the Engineer.

Materials

(A) Geomembrane

Provide geomembrane that is impermeable, composed of polyethylene polymers or polyvinyl chloride, and meets the following physical requirements:

Property	Requirements	Test Method
Thickness	25 mils Minimum	ASTM D1593
Tensile Strength at Break	100 lb/inch Minimum	ASTM D638
Puncture Strength	40 lbs Minimum	ASTM D 4833
Moisture Vapor Transmission Rate	0.018 oz/yd ² per Day Maximum	ASTM E96

(B) Fabric

Refer to Section 1056 for Type 2 Engineering Fabric and the following:

Use a woven fabric consisting of strong rot-proof synthetic fibers such as polypropylene, polyethylene, or polyester formed into a stable network such that the filaments or yarns retain their relative positions to each other.

Fabric Property	Requirements	Test Method
Minimum Flow Rate	2 gallons/min/square foot	ASTM D 4491

Lamination of fabric sheets to produce the physical requirements of a fabric layer will not be accepted. Furnish letters of certification from the manufacturer with each shipment of

the fabric and geomembrane attesting that the material meets the requirements of this provision; however, the material is subject to inspection, test, or rejection by the Engineer at any time.

During all periods of shipment and storage, wrap the geomembrane and fabric in a heavy-duty protective covering to protect the material from ultraviolet rays. After the protective wrapping has been removed, do not leave the material uncovered under any circumstances for longer than 4 days.

(C) Select Material

Provide select material meeting the requirements of Class III, Type 1 or Type 2, or Class V select material of Section 1016 of the *2006 Standard Specifications*. When select material is required under water, use select material class V only, up to one foot above the existing water elevation.

(D) 4 inch Diameter Corrugated Drainage Pipe and Fittings

Provide pipe and fittings that meet all the applicable requirements of Section 815 or 816 of the *2006 Standard Specifications*.

Construction Methods

Place the geomembrane and fabric as shown on the plans or as directed by the Engineer. Perform the excavation for the fabric reinforced fill to the limits shown on the plans. Provide an excavated surface free of obstructions, debris, pockets, stumps, and cleared of all vegetation. The geomembrane or fabric will be rejected if it has defects, rips, holes, flaws, deterioration or damage incurred during manufacture, transportation, handling or storage. Lay all layers smooth, and free from tension, stress, folds, wrinkles or creases. Place all the fabric layers with the machine direction (roll direction) parallel to the centerline of the roadway. A minimum roll width of 10.0 feet for the fabric is required. Overlap geomembrane or fabric splices parallel to the centerline of the roadway a minimum of 18 inches. Geomembrane or fabric splices parallel to the backwall face will not be allowed.

Deposit and spread select material in successive, uniform, approximately horizontal layers of not more than 10 inches in depth, loose measurement, for the full width of the cross section, and keep each layer approximately level. Place and compact each layer of select material fill no more than 10 inches thick with low ground pressure equipment. Use hand operated equipment to compact the fill material within three feet of the backwall and wingwalls as directed by the Engineer. Compact select material to a density equal to at least 95% of that obtained by compacting a sample of the material in accordance with AASHTO T99 as modified by the Department. Compact the top eight inches of select material to a density to at least 100% of that obtained by compacting a sample of the material in accordance with AASHTO T99 as modified by the Department. Density requirements are not applicable to select material, class V; however compact the fill with at least four passes of low ground pressure equipment on the entire surface as directed by the Engineer. The compaction of each layer of select material shall be inspected

and approved by the Department prior to the placement of the next fill layer. No equipment will be allowed to operate on the drainage pipe or any geomembrane/fabric layer until it is covered with at least six inches of fill material. Compaction shall not damage the drainage pipe, geomembrane, or fabric under the fill. Cover the geomembrane/fabric with a layer of fill material within four days after placement of the geomembrane/fabric. Geomembrane and fabric that are damaged as a result of installation will be replaced as directed by the Department at no additional cost.

Place the geomembrane on the ground, and attach and secure it tightly to the vertical face of the backwall and wingwalls with adhesives, duct-tape, nails or any other method approved by the Engineer. Place the first fabric layer on the surface of the geomembrane with the same dimensions of the geomembrane. No material or void is allowed between the geomembrane and the first fabric layer. Place and fold the remaining fabric layers on the edges as shown on the plans or as directed by the Engineer. Provide vertical separation between fabric layers as specified on the plans. The number of fabric layers will be shown in the plans.

Place four inch diameter perforated drainage pipe along the base of the backwall and sloped to drain as shown on the plans. Completely wrap perforated drainage pipe and #78M stone with Type 2 Engineering Fabric as shown on the plan detail. Install a pipe sleeve through the bottom of or under the wing wall prior to placing concrete for the wing wall. The pipe sleeve shall be of adequate strength to withstand the wingwall load. Place the pipe sleeve in position to allow the drainage pipe to go through the wing wall with a proper slope. Connect four-inch diameter nonperforated (plain) drainage pipe with a coupling to the perforated pipe near the inside face of the wingwall. Place the nonperforated drainage pipe through the pipe sleeve, extend down to the toe of the slope and connect, to a ditch or other drainage systems as directed by the Engineer. For bridge approaches in cut sections where no side slope is available, direct the drainage pipe outlet to the end slope down to the toe using elbows as directed by the Engineer.

FINE GRADING SUBGRADE, SHOULDERS AND DITCHES

(7-21-09)

DB5 R001

Revise the *Standard Specifications* as follows:

Page 5-1, Article 500-1 Description, replace the first sentence with the following:

Perform the work covered by this section including but not limited to preparing, grading, shaping, manipulating moisture content, and compacting either an unstabilized or stabilized roadbed to a condition suitable for placement of base course, pavement, and shoulders.

Page 5-1, Subarticle 500-2(A) General, insert the following as the fifth paragraph:

Control the moisture content of the material by drying or adding water.

AGGREGATE BASE COURSE

12-19-06

DB5 R03

Revise the 2006 *Standard Specifications for Roads and Structures* as follows:

Page 5-11, Article 520-5 Hauling and Placing Aggregate Base Material, 6th paragraph, replace the first sentence with the following:

Base course that is in place on November 15 shall have been covered with a subsequent layer of pavement structure or with a sand seal. Base course that has been placed between November 16 and March 15 inclusive shall be covered within 7 calendar days with a subsequent layer of pavement structure or with a sand seal.

PREPARATION OF SUBGRADE AND BASE

(1-16-96)

DB5 R05

On mainline portions and ramps of this project, prepare the subgrade and base beneath the pavement structure in accordance with the applicable sections of the Standard Specifications except use an automatically controlled fine grading machine utilizing string lines, laser controls, or other approved methods to produce final subgrade and base surfaces meeting the lines, grades, and cross sections required by the plans or established by the Engineer.

AGGREGATE FOR SOIL-CEMENT BASE

(7-18-06)

DB5 R15

Revise the 2006 *Standard Specifications for Roads and Structures* as follows:

Page 5-27, Article 542-1. Delete the first sentence and substitute the following:

The work covered by this section consists of constructing and curing a soil-cement base by treating the subgrade, existing subbase, or existing base, or any combination of these materials, by pulverizing, adding portland cement, adding aggregate when required, mixing, wetting, and compacting the mixture to the required density.

Page 5-27, Article 542-2. Add the following:

Item	Section
Aggregate, Std. Size ABC	1005

Page 5-29, Article 542-7. Add the following after the first paragraph:

Prior to spreading cement, aggregate shall be spread at the rate shown in the plans.

ASPHALT PAVEMENTS - SUPERPAVE

(09-14-09)

DB6 R01

Revise the *2006 Standard Specifications* as follows:

Page 6-2, Article 600-9 Measurement and Payment, delete the second paragraph.

Page 6-12, Subarticle 609-5(C)2, Required Sampling and Testing Frequencies, first partial paragraph at the top of the page, delete last sentence and add the following:

If the Engineer allows the mix to remain in place, payment will be made in accordance with Article 105-3.

Page 6-12, Subarticle 609-5(C)2, QUALITY CONTROL MINIMUM SAMPLING AND TESTING SCHEDULE

First paragraph, delete and replace with the following.

Sample and test the completed mixture from each mix design per plant per year at the following minimum frequency during mix production:

Second paragraph, delete the fourth sentence, and replace with the following

When daily production of each mix design exceeds 100 tons and a regularly scheduled full test series random sample location for that mix design does not occur during that day's production, perform at least one partial test series consisting of Items A and B in the schedule below.

Page 6-12, Subarticle 609-5(C)2(c) Maximum Specific Gravity, add after (AASHTO T 209):

or ASTM D 2041

Page 6-13, last line and on Page 6-14, Subarticle 609-5(C)2(e) Retained Tensile Strength, add a heading before the first paragraph as follows:

(i) Option 1

Insert the following immediately after the first paragraph:

(ii) Option 2

Mix sampled from truck at plant with one set of specimens prepared by the Contractor and then tested jointly by QA and QC at a mutually agreed upon lab site within the first 7 calendar days after beginning production of each new mix design.

Second paragraph, delete and replace with the following:

Test all TSR specimens required by either option noted above on either a recording test press or a test press that maintains the peak load reading after the specimen has broken.

Subarticle 609-5(C)(3) Control Charts, delete the second sentence of the first paragraph and replace with the following:

For mix incorporated into the project, record full test series data from all regularly scheduled random samples or directed samples that replace regularly scheduled random samples, on control charts the same day the test results are obtained.

Page 6-15, Subarticle 609-5(C)(3) Control Charts, first paragraph on this page, delete the last sentence and substitute the following:

Denote the moving average control limits with a dash green line and the individual test limits with a dash red line.

Subarticle 609-5(C)(3)(a), (b) and (c), replace (a) (b) and (c) with the following:

- (a) A change in the binder percentage, aggregate blend, or G_{mm} is made on the JMF, or,
- (b) When the Contractor elects to stop or is required to stop production after one or two moving average values, respectively, fall outside the moving average limits as outlined in subarticle 609-5(C)6 or,
- (c) If failure to stop production after two consecutive moving averages exceed the moving average limits occurs, but production does stop at a subsequent time, re-establish a new moving average beginning at the actual production stop point.

Subarticle 609-5(C)(4) Control Limits, replace the first paragraph and the CONTROL LIMITS Table on page 6-16 with the following.

The following are established as control limits for mix production. Apply the individual limits to the individual test results. Control limits for the moving average limits are based on a moving average of the last 4 data points. Apply all control limits to the applicable target source.

CONTROL LIMITS

Mix Control Criteria	Target Source	Moving Average Limit	Individual Limit
2.36 mm Sieve	JMF	± 4.0 %	± 8.0 %
0.075 mm Sieve	JMF	± 1.5 %	± 2.5 %
Binder Content	JMF	± 0.3 %	± 0.7 %
VTM @ N _{des}	JMF	± 1.0 %	± 2.0 %
VMA @ N _{des}	Min. Spec. Limit	Min. Spec. Limit	- 1.0%
P _{0.075} / P _{be} Ratio	1.0	± 0.4	± 0.8
%G _{mm} @ N _{ini}	Max. Spec. Limit	N/A	+ 2.0%
TSR	Min. Spec. Limit	N/A	- 15%

Page 6-16, Subarticle 609-5(C)(5) Warning Bands, delete this subarticle in its entirety.

Pages 6-16 through 6-19, Subarticle 609-5(C)(6), delete the word "warning" and substitute the words "moving average".

Page 6-16, Subarticle 609-5(C)(6) Corrective Actions, first paragraph, first sentence, delete and replace with the following:

Immediately notify the Engineer when moving averages exceed the moving average limits.

Page 6-17, third full paragraph, delete and replace with the following:

Failure to stop production when required due to an individual mix test not meeting the specified requirements will subject all mix from the stop point tonnage to the point when the next individual test is back on or within the moving average limits, or to the tonnage point when production is actually stopped, whichever occurs first, to being considered unacceptable.

Sixth full paragraph, delete the first, second, and third sentence and replace with the following:

Immediately notify the Engineer when any moving average value exceeds the moving average limit. If two consecutive moving average values for any one of the mix control criteria fall outside the moving average limits, cease production of that mix, immediately notify the Engineer of the stoppage, and make adjustments. The Contractor may elect to stop production after only one moving average value falls outside the moving average limits.

Page 6-18, Subarticle 609-5(C)(6) Corrective Actions second full paragraph, delete and replace with the following:

If the process adjustment improves the property in question such that the moving average after four additional tests is on or within the moving average limits, the Contractor may continue production with no reduction in payment.

Page 6-18, delete the third and fourth full paragraphs, including the Table for Payment for Mix Produced in the Warning Bands and substitute the following:

If the adjustment does not improve the property in question such that the moving average after four additional individual tests is outside the moving average limits, the mix will be evaluated for acceptance in accordance with Article 105-3. Reduced payment for or removal of the mix in question will be applied starting from the plant sample tonnage at the stop point to the sample tonnage when the moving average is on or within the moving average limits. In addition, any mix that is obviously unacceptable will be rejected for use in the work.

Page 6-19, First paragraph, delete and replace with the following:

Failure to stop production and make adjustments when required due to two consecutive moving average values falling outside the moving average limits will subject all mix produced from the stop point tonnage to the tonnage point when the moving average is back on or within the moving average limits or to the tonnage point when production is actually stopped, whichever occurs first, to being considered unacceptable. Remove this material and replaced with materials that comply with the Specifications at no additional costs to the Department, unless otherwise approved. Payment will be made for the actual quantities of materials required to replace the removed quantities, not to exceed the original amounts.

Page 6-20, Subarticle 609-5(D)(1) General, delete the third full paragraph, and replace with the following:

Perform the sampling and testing at the minimum test frequencies as specified above. Should the density testing frequency fail to meet the minimum frequency as specified above, all mix without the required density test representation will be considered unsatisfactory. If the Engineer allows the mix to remain in place, payment will be made in accordance with Article 105-3.

Page 6-22, Subarticle 609-5(D)(4) Nuclear Gauge Density Procedures, third paragraph, insert the following as the second sentence:

Determine the Daily Standard Count in the presence of the QA Roadway Technician or QA Nuclear Gauge Technician on days when a control strip is being placed.

Page 6-23, Subarticle 609-5(D)(5) Limited Production Procedure, delete the first paragraph including (a), (b), (c) and substitute the following:

Proceed on limited production when, for the same mix type and on the same contract, one of the following conditions occur (except as noted in the first paragraph below).

- (a) Two consecutive failing lots, except on resurfacing*
- (b) Three consecutive failing lots on resurfacing*
- (c) Two consecutive failing nuclear control strips.

* Resurfacing is defined as the first new uniform layer placed on an existing pavement.

Page 6-25, Article 609-6 Quality Assurance, Density Quality Assurance, insert the following items after item (E):

- (F) By retesting Quality Control core samples from control strips (either core or nuclear) at a frequency of 100% of the frequency required of the Contractor;
- (G) By observing the Contractor perform all standard counts of the Quality Control nuclear gauge prior to usage each nuclear density testing day; or
- (H) By any combination of the above

Page 6-28, Subarticle 610-3(A) Mix Design-General, delete the fourth and fifth paragraphs and replace with the following:

Reclaimed Asphalt Pavement (RAP) or Reclaimed Asphalt Shingles (RAS) may be incorporated into asphalt plant mixes in accordance with Article 1012-1 and the following applicable requirements.

Reclaimed asphalt pavement (RAP) may constitute up to 50% of the total material used in recycled mixtures, except for mix Type S12.5D, Type S9.5D, and mixtures containing reclaimed asphalt shingle material (RAS). Reclaimed asphalt shingle (RAS) material may constitute up to 6% by weight of total mixture for any mix. When both RAP and RAS are used, do not use a combined percentage of RAS and RAP greater than 20% by weight of total mixture, unless otherwise approved. When the percent of binder contributed from RAS or a combination of RAS and RAP exceeds 20% but not more than 30% of the total binder in the completed mix, the virgin binder PG grade shall be one grade below (both high and low temperature grade) the binder grade specified in Table 610-2 for the mix type, unless otherwise approved. When the percent of binder contributed from RAS or a combination of RAS and RAP exceeds 30% of the total binder in the completed mix, the Engineer will establish and approve the virgin binder PG grade. Use approved methods to determine if any binder grade adjustments are necessary to achieve the performance grade for the specified mix type.

For Type S12.5D and Type S9.5D mixes, the maximum percentage of reclaimed asphalt material is limited to 20% and shall be produced using virgin asphalt binder grade PG 76-22. For all other recycled mix types, the virgin binder PG grade shall be as specified in Table 610-2A for the specified mix type.

When the percentage of RAP is greater than 20% but not more than 30% of the total mixture, use RAP meeting the requirements for processed or fractionated RAP in accordance with the requirements of Section 1012-1.

When the percentage of RAP is greater than 30% of the total mixture, use an approved stockpile of RAP in accordance with Section 1012-1(C). Use approved test methods to determine if any binder grade adjustments are necessary to achieve the performance grade for the specified mix type. The Engineer will establish and approve the virgin asphalt binder grade to be used.

Page 6-34, Subarticle 610-3(C), delete Table 610-2 and associated notes. Substitute the following:

**TABLE 610-2
SUPERPAVE MIX DESIGN CRITERIA**

Mix Type	Design ESALs Millions (a)	Binder PG Grade (b)	Compaction Levels No. Gyration @		Max. Rut Depth (mm)	Volumetric Properties (c)			
			N _{ini}	N _{des}		VMA % Min.	VTM %	VFA Min. - Max.	%G _{mm} @ N _{ini}
S4.75A(e)	< 0.3	64 -22	6	50	-----	20.0	7.0 - 15.0	-----	-----
SF9.5A	< 0.3	64 -22	6	50	11.5	16.0	3.0 - 5.0	70 - 80	≤ 91.5
S9.5B	0.3 - 3	64 -22	7	65	9.5	15.5	3.0 - 5.0	65 - 80	≤ 90.5
S9.5C	3 - 30	70 -22	7	75	6.5	15.5	3.0 - 5.0	65 - 78	≤ 90.5
S9.5D	> 30	76 -22	8	100	4.5	15.5	3.0 - 5.0	65 - 78	≤ 90.0
S12.5C	3 - 30	70 -22	7	75	6.5	14.5	3.0 - 5.0	65 - 78	≤ 90.5
S12.5D	> 30	76 -22	8	100	4.5	14.5	3.0 - 5.0	65 - 78	≤ 90.0
I19.0B	< 3	64 -22	7	65	-----	13.5	3.0 - 5.0	65 - 78	≤ 90.5
I19.0C	3 - 30	64 -22	7	75	-----	13.5	3.0 - 5.0	65 - 78	≤ 90.0
I19.0D	> 30	70 -22	8	100	-----	13.5	3.0 - 5.0	65 - 78	≤ 90.0
B25.0B	< 3	64 -22	7	65	-----	12.5	3.0 - 5.0	65 - 78	≤ 90.5
B25.0C	> 3	64 -22	7	75	-----	12.5	3.0 - 5.0	65 - 78	≤ 90.0
All Mix Types	Design Parameter 1. Dust to Binder Ratio (P _{0.075} / P _{be}) 2. Retained Tensile Strength (TSR) (AASHTO T283 Modified)					Design Criteria 0.6 – 1.4 85% Min. (d)			

Notes: (a) Based on 20 year design traffic

- (b) When Recycled Mixes are used, select the binder grade to be added in accordance with Subarticle 610-3(A)
- (c) Volumetric Properties based on specimens compacted to N_{des} as modified by the Department
- (d) AASHTO T 283 Modified (No Freeze-Thaw cycle required). TSR for Type S 4.75A, Type B 25.0B, and Type B 25.0C mixes is 80% minimum
- (e) Mix Design Criteria for Type S 4.75A may be modified subject to the approval of the Engineer

Page 6-34, Insert the following immediately after Table 610-2:

**TABLE 610-2A
SUPERPAVE MIX DESIGN CRITERIA**

	Percentage of RAP in Mix		
	Category 1	Category 2	Category 3
Mix Type	% RAP \leq 20%	20.1% \leq %RAP \leq 30.0%	%RAP $>$ 30.0%
All A and B Level Mixes, I19.0C, B25.0C	PG 64 -22	PG 64 -22	TBD
S9.5C, S12.5C, I19.0D	PG 70 -22	PG 64-22	TBD
S9.5D and S12.5D	PG 76-22	N/A	N/A

- Note: (1) Category 1 RAP has been processed to a maximum size of 2 inches.
- (2) Category 2 RAP has been processed to a maximum size of 1 inch by either crushing and / or screening to reduce variability in the gradations.
- (3) Category 3 RAP has been processed to a maximum size of 1 inch, fractionating the RAP into 2 or more sized stockpiles

Page 6-35, Table 610-3 delete and replace with the following:

**TABLE 610-3
ASPHALT PLACEMENT- MINIMUM TEMPERATURE REQUIREMENTS**

Asphalt Concrete Mix Type	Minimum Air Temperature	Minimum Surface Temperature
ACBC, Type B25.0B, C, B37.5C	35° F	35° F
ACIC, Type I19.0B, C, D	35° F	35° F
ACSC, Type S4.75A, SF9.5A, S9.5B	40° F	50° F*
ACSC, Type S9.5C, S12.5C	45° F	50° F
ACSC, Type S9.5D, S12.5D	50° F	50° F

* 35° F if surface is soil or aggregate base for secondary road construction.

Page 6-44, Article 610-8 Spreading and Finishing, third full paragraph, replace the first sentence with the following:

Use the 30 foot minimum length mobile grade reference system or the non-contacting laser or sonar type ski *with at least four referencing stations mounted on the paver at a minimum length of 24 feet* to control the longitudinal profile when placing the initial lanes and all adjacent lanes of all layers, including resurfacing and asphalt in-lays, unless otherwise specified or approved.

Page 6-50, Article 610-13 Density Acceptance, delete the second paragraph and replace with the following:

As an exception, when the first layer of mix is a surface course and is being placed directly on an unprimed aggregate or soil base, the layer will be included in the "Other" construction category.

Page 6-50, Article 610-13 Density Acceptance, delete the formula and description in the middle of the page and replace with the following:

where: $PF = 100 - 10(D)^{1.465}$
PF = Pay Factor (computed to 0.1%)
D = the deficiency of the lot average density,
not to exceed 2.0%

Page 6-53, Article 620-4 Measurement and Payment

Sixth paragraph, delete the last sentence.

Seventh paragraph, delete the paragraph and replace with the following:

The adjusted contract unit price will then be applied to the theoretical quantity of asphalt binder authorized for use in the plant mix placed during the partial payment period involved, except that where recycled plant mix is used, the adjusted unit price will be applied only to the theoretical number of tons of additional asphalt binder materials required by the job mix formula.

Page 6-54, Article 620-4 Measurement and Payment, add the following pay item:

Pay Item	Pay Unit
Asphalt Binder for Plant Mix, Grade PG 70-28	Ton

Page 6-69, Table 660-1 Material Application Rates and Temperatures, add the following:

Type of Coat	Grade of Asphalt	Asphalt Rate Gal / yd ²	Application Temperature °F	Aggregate Size	Aggregate Rate lb. / sq. yd. Total
Sand Seal	CRS-2 or CRS-2P	0.22-0.30	150-175	Blotting Sand	12-15

Page 6-75, Subarticle 660-9(B), add the following as sub-item (5)

(5) Sand Seal

Place the fully required amount of asphalt material in one application and immediately cover with the seal coat aggregate. Uniformly spread the fully required amount of aggregate in one application and correct all non-uniform areas prior to rolling.

Immediately after the aggregate has been uniformly spread, perform rolling.

When directed, broom excess aggregate material from the surface of the seal coat.

When the sand seal is to be constructed for temporary sealing purposes only and will not be used by traffic, other grades of asphalt material meeting the requirements of Articles 1020-6 and 1020-7 may be used in lieu of the grade of asphalt required by Table 660-1 when approved.

Page 6-76, Article 661-1 Description, add the following as the 2nd paragraph:

Provide and conduct the quality control and required testing for acceptance of the UBWC in accordance with "Quality Management System for Asphalt Pavements (OGAFC, PADL, and Ultra-Thin HMA Version)", included in the contract.

Page 6-80, Subarticle 661-3(A) Equipment, add the following as the first paragraph:

Use asphalt mixing plants in accordance with Article 610-5.

Page 10-41, Table 1012-1, delete the last row of entries for OGAFC and add the following:

Mix Type	Course Aggregate Angularity ^(b) ASTM D5821	Fine Aggregate Angularity % Minimum AASHTO T304 Method A	Sand Equivalent % Minimum AASHTO T176	Flat & Elongated 5:1 Ratio % Maximum ASTM D4791 Section 8.4
S9.5 D	100/100	45	50	10
OGAFC	100/100	N/A	N/A	10
UBWC	100/85	40	45	10

Delete Note (c) under the Table 1012-1 and replace with the following:

(c) Does not apply to Mix Types SF9.5A and S9.5B.

Page 10-43, Subarticle 1012-1(F): Reclaimed Asphalt Shingle Material (RAS), insert the following immediately following the first paragraph:

(1) Mix Design RAS

Incorporate RAS from stockpiles that have been tested for uniformity of gradation and binder content prior to use in an asphalt mix design.

(2) Mix Production RAS

New Source RAS is defined as acceptable material which was not included in the stockpile when samples were taken for mix design purposes. Process new source RAS so that all materials will pass a 1/2" inch sieve prior to introduction into the plant mixer unit.

After a stockpile of processed RAS has been sampled and mix designs made from these samples, do not add new source RAS to the original stockpile without prior field testing to insure gradation and binder uniformity. Sample and test new source RAS before blending with the existing stockpile.

Store new source RAS in a separate stockpile until the material can be sampled and tested for comparison with the original recycled mix design data. New source RAS may also be placed against the existing stockpile in a linear manner provided it is sampled for mix design conformity prior to its use in the recycled mix.

RAS contamination including but not limited to excessive dirt, debris, clean stone, concrete will not be allowed.

Field approval of new source RAS will be based on Table 1012-3 below and volumetric mix properties on the mix with the new source RAS included. Provided the Table 1012-3 tolerances are met, volumetric properties of the new mix will then be performed. If all volumetric mix properties meet the mix design criteria for that mix type, the new source RAS may continue to be used.

If the gradation, binder content, or any of the volumetric mix properties are not within the allowable tolerances of Table 1012-3, do not use the new source RAS unless approved by the Engineer. The Contractor may elect to either not use the stockpile, to request an adjustment to the JMF, or to redesign the mix.

**TABLE 1012-3
NEW SOURCE RAS GRADATION and BINDER TOLERANCES
(Apply Tolerances to Mix Design Data)**

0-6% RAS	
P _b %	± 1.6%
Sieve Size (mm)	Tolerance
9.5	± 1
4.75	± 5
2.36	± 4
1.18	± 4
0.300	± 4
0.150	± 4
0.075	± 2.0

Page 10-43 through 10-45, Subarticle 1012-1(G), delete this in its entirety and replace with the following:

(G) Reclaimed Asphalt Pavement (RAP)

(1) Mix Design RAP

Incorporate RAP from stockpiles or other sources that have been tested for uniformity of gradation and binder content prior to use in an asphalt mix design. Use reclaimed asphalt pavement that meets all requirements specified for *one of* the following *two* classifications.

(a) Millings

Existing reclaimed asphalt pavement (RAP) that is removed from its original location by a milling process as specified in Section 607. Millings should be such that it has a uniform gradation and binder content and all materials will pass a 2" sieve prior to introduction into the plant mixer unit.

(b) Processed RAP

RAP that is processed in some manner (possibly by crushing and / or use of a blending method) to produce a uniform gradation and binder content in the RAP prior to use in a recycled mix. Process RAP so that all materials have a uniform gradation and binder content and will pass a 1" sieve prior to introduction into the plant mixer unit.

(c) Fractionated RAP

Fractionated RAP is defined as having two or more RAP stockpiles, where the RAP is divided into coarse and fine fractions. Grade RAP so that all materials will pass a 1" sieve. The coarse RAP stockpile shall only contain material retained on a 3/8 inch screen, unless otherwise approved. The fine RAP stockpile shall only contain material passing the 3/8" screen, unless otherwise approved. The Engineer may allow the Contractor to use an alternate to the 3/8 inch screen to fractionate the RAP. The maximum percentages of fractionated RAP may be comprised of coarse, fine, or the combination of both. Utilize a separate cold feed bin for each stockpile of fractionated RAP used.

(d) Approved Stockpiled RAP

Approved Stockpiled RAP is defined as fractionated RAP which has been isolated and tested for asphalt content, gradation, and asphalt binder characteristics with the intent to be used in mix designs with greater than 30% RAP materials. Fractionate the RAP in accordance with Section 1012-1(G)(c). Utilize a separate cold feed bin for each approved stockpile of RAP used.

Perform extraction tests at a rate of 1 per 1000 tons of RAP, with a minimum of 5 tests per stockpile to determine the asphalt content and gradation. Separate stockpiles of RAP material by fine and coarse fractions. Erect and maintain a sign satisfactory to the Engineer on each stockpile to identify the material. Assure that no deleterious material is allowed in any stockpile. The Engineer may reject by visual inspection any stockpiles that are not kept clean, separated, and free of foreign materials.

Submit requests for RAP stockpile approval to the Engineer with the following information at the time of the request:

- (1) Approximate tons of materials in stockpile
- (2) Name or Identification number for the stockpile
- (3) Asphalt binder content and gradation test results
- (4) Asphalt characteristics of the Stockpile.

For the Stockpiled RAP to be considered for approval, the gradation and asphalt content shall be uniform. Individual test results, when compared to the target, will be accepted if within the tolerances listed below:

**APPROVED STOCKPILED RAP GRADATION
and BINDER TOLERANCES
(Apply Tolerances to Mix Design Data)**

P_b %	$\pm 0.3\%$
Sieve Size (mm)	Percent Passing
25.0	$\pm 5\%$
19.0	$\pm 5\%$
12.5	$\pm 5\%$
9.5	$\pm 5\%$
4.75	$\pm 5\%$
2.36	$\pm 4\%$
1.18	$\pm 4\%$
0.300	$\pm 4\%$
0.150	$\pm 4\%$
0.075	$\pm 1.5\%$

Note: If more than 20% of the individual sieves are out of the gradation tolerances, or if more than 20% of the asphalt binder content test results fall outside the appropriate tolerances, the RAP shall not be used in HMA unless the RAP representing the failing tests is removed from the stockpile.

Do not add additional material to any approved RAP stockpile, unless otherwise approved by the Engineer.

Maintain at the plant site a record system for all approved RAP stockpiles. Include at a minimum the following: Stockpile identification and a sketch of all stockpile areas at the plant site; all RAP test results (including asphalt content, gradation, and asphalt binder characteristics).

(2) Mix Production RAP

During mix production, use RAP that meets the criteria for one of the following categories:

(a) Mix Design RAP

RAP contained in the mix design stockpiles as described above may be used in all applicable JMFs. These stockpiles have been pretested; however, they are subject to required QC / QA testing in accordance with Subarticle 609-5(C)(2).

(b) New Source RAP

New Source RAP is defined as any acceptable material that was not included in the stockpile or other source when samples were taken for mix design purposes. Process new source RAP so that all materials have a uniform gradation and binder content and will pass a 2" sieve prior to introduction into the plant mixer unit.

After a stockpile of millings, processed RAP, or fractionated RAP has been sampled and mix designs made from these samples, do not add new source RAP to the original stockpile without prior field testing to insure gradation and binder uniformity. Sample and test new source RAP before blending with the existing stockpile.

Store new source RAP in a separate stockpile until the material can be sampled and tested for comparison with the original recycled mix design data. New source RAP may also be placed against the existing stockpile in a linear manner provided it is sampled for mix design conformity prior to its use in the recycled mix.

Unprocessed RAP is asphalt material that was not milled and/ or has not been processed to obtain a uniform gradation and binder content and is not representative of the RAP used during the applicable mix design. Unprocessed RAP shall not be incorporated into any JMFs prior to processing. Different sources of unprocessed RAP may be stockpiled together provided it is generally free of contamination and will be processed prior to use in a recycled mix. RAP contamination in the form of excessive dirt, debris, clean stone, concrete, etc. will not be allowed. Incidental amounts of dirt, concrete, and clean stone may be acceptable. Unprocessed RAP may be processed and then classified as a new source RAP as described above.

Field approval of new source RAP will be based on Table 1012-2 below and volumetric mix properties on the mix with the new source RAP included. Provided the Table 1012-2 tolerances are met, volumetric properties of the new mix will then be performed. If all volumetric mix properties meet the mix design criteria for that mix type, the new source RAP may continue to be used.

If the gradation, binder content, or any of the volumetric mix properties are not within the allowable tolerances of Table 1012-2, do not use the new source RAP unless approved by the Engineer. The Contractor may elect to either not use the stockpile, to request an adjustment to the JMF, or to redesign the mix.

TABLE 1012-2 NEW SOURCE RAP GRADATION and BINDER TOLERANCES (Apply Tolerances to Mix Design Data)									
Mix Type	0 - 20% RAP			20 ⁺ - 30 % RAP			30 ⁺ % RAP		
Sieve (mm)	Base	Inter.	Surf.	Base	Inter.	Surf.	Base	Inter.	Surf.
P _b %	± 0.7%			± 0.4%			± 0.3%		
25.0	± 10	-	-	± 7	-	-	± 5	-	-
19.0	± 10	± 10	-	± 7	± 7	-	± 5	± 5	-
12.5	-	± 10	± 10	-	± 7	± 7	-	± 5	± 5
9.5	-	-	± 10	-	-	± 7	-	-	± 5
4.75	± 10	-	± 10	± 7	-	± 7	± 5	-	± 5
2.36	± 8	± 8	± 8	± 5	± 5	± 5	± 4	± 4	± 4
1.18	± 8	± 8	± 8	± 5	± 5	± 5	± 4	± 4	± 4
0.300	± 8	± 8	± 8	± 5	± 5	± 5	± 4	± 4	± 4
0.150	-	-	± 8	-	-	± 5	-	-	± 4
0.075	± 4	± 4	± 4	± 2	± 2	± 2	± 1.5	± 1.5	± 1.5

ASPHALT PAVER - FIXED AND MOBILE STRING LINE

07-21-09

DB6 R07

The Design Build Team's attention is directed to Article 610-8 of the 2006 *Standard Specifications for Roads and Structures* dealing with automatically controlled screeds on the asphalt pavement spreaders.

A mobile string line consisting of a 30 to 40 foot long ski is required for the widening and resurfacing on this project. A fixed string line is required for the new pavement construction on this project.

ASPHALT BINDER CONTENT OF ASPHALT PLANT MIXES

(10-6-05)

DB6 R15

The approximate asphalt binder content of the asphalt concrete plant mixtures used on this project will be as follows:

Asphalt Concrete Base Course	Type B 25.0_	4.3%
Asphalt Concrete Intermediate Course	Type I 19.0_	4.7%
Asphalt Concrete Surface Course	Type S 4.75_	7.0%
Asphalt Concrete Surface Course	Type SF 9.5_	6.5%
Asphalt Concrete Surface Course	Type S 9.5_	6.0%
Asphalt Concrete Surface Course	Type S 12.5_	5.5%

The actual asphalt binder content will be established during construction by the Engineer within the limits established in the *2006 Standard Specifications* or Project Special Provisions.

FINAL SURFACE TESTING - ASPHALT PAVEMENTS

(07/15/08)

DB6 R45

On portions of this project where the typical section requires two or more layers of new pavement, perform acceptance testing of the longitudinal profile of the finished pavement surface in accordance with these provisions using a North Carolina Hearne Straightedge (Model No. 1). Furnish and operate the straightedge to determine and record the longitudinal profile of the pavement on a continuous graph. Final surface testing is an integral part of the paving operation and is subject to observation and inspection by the Engineer as deemed necessary.

Push the straightedge manually over the pavement at a speed not exceeding 2 miles per hour (3 kilometers per hour). For all lanes, take profiles in the right wheel path approximately 3 ft (1 m) from the right edge of pavement in the same direction as the paving operation, unless otherwise approved due to traffic control or safety considerations. As an exception, lanes adjacent to curb and gutter, expressway gutter, or shoulder berm gutter may be tested in the left wheel path. Make one pass of the straightedge in each full width travel lane. The full lane width should be comparable in ride quality to the area evaluated with the Hearne Straightedge. If deviations exist at other locations across the lane width, utilize a 10 foot (3 meters) non-mobile straightedge or the Hearne Straightedge to evaluate which areas may require corrective action. Take profiles as soon as practical after the pavement has been rolled and compacted but in no event later than 24 hours following placement of the pavement, unless otherwise authorized by the Engineer. Take profiles over the entire length of final surface travel lane pavement exclusive of -Y- line travel lanes less than or equal to 1000 feet (300 meters) in length, ramps less than or equal to 1000 feet (300 meters) in length, turn lanes less than or equal to 1000 feet (300 meters) in length, structures, approach slabs, paved shoulders, loops, and tapers or other irregular shaped areas of pavement, unless otherwise approved by the Engineer. Test in accordance with this provision all mainline travel lanes, full width acceleration or deceleration lanes, -Y- line travel lanes greater than 1000 feet (300 meters) in length, ramps, full width turn lanes greater than 1000 feet (300 meters) in length, and collector lanes.

At the beginning and end of each day's testing operations, and at such other times as determined necessary by the Engineer, operate the straightedge over a calibration strip so that the Engineer can verify correct operation of the straightedge. The calibration strip must be a 100 ft (30 m) section of pavement that is reasonably level and smooth. Submit each day's calibration graphs with that day's test section graphs to the Engineer. Calibrate the straightedge in accordance with the current NCDOT procedure titled "North Carolina Hearne Straightedge - Calibration and Determination of Cumulative Straightedge Index". Copies of this procedure may be obtained from the Department's Pavement Construction Section.

Plot the straightedge graph at a horizontal scale of approximately 25 ft per inch (3 m per cm) with the vertical scale plotted at a true scale. Record station numbers and references (bridges, approach slabs, culverts, etc.) on the graphs, and distances between references/stations must not exceed 100 ft (30 m). Have the operator record the Date, Project No., Lane Location, Wheel Path Location, Type Mix, and Operator's Name on the graph.

Upon completion of each day's testing, evaluate the graph, calculate the Cumulative Straightedge Index (CSI), and determine which lots, if any, require corrective action. Document the evaluation of each lot on a QA/QC-7 form. Submit the graphs along with the completed QA/QC-7 forms to the Engineer, within 24 hours after profiles are completed, for verification of the results. The Engineer will furnish results of their acceptance evaluation to the Design-Build Team within 48 hours of receiving the graphs. In the event of discrepancies, the Engineer's evaluation of the graphs will prevail for acceptance purposes. The Engineer will retain all graphs and forms.

Use blanking bands of 0.2 inches, 0.3 inches, and 0.4 inches (5 mm, 7.5 mm, and 10 mm) to evaluate the graph for acceptance. The 0.2 inch and 0.3 inch (5 mm and 7.5 mm) blanking bands are used to determine the Straightedge Index (SEI), which is a number that indicates the deviations that exceed each of the 0.2 inch and 0.3 inch (5 mm and 7.5 mm) bands within a 100 ft (30 m) test section. The Cumulative Straightedge Index (CSI) is a number representing the total of the SEIs for one lot, which consist of not more than 25 consecutive test sections. In addition, the 0.4 inch (10 mm) blanking band is used to further evaluate deviations on an individual basis. The Cumulative Straightedge Index (CSI) will be determined by the Engineer in accordance with the current procedure titled "North Carolina Hearne Straightedge - Calibration and Determination of Cumulative Straightedge Index".

The pavement will be accepted for surface smoothness on a lot by lot basis. A test section represents pavement one travel lane wide not more than 100 ft (30 m) in length. A lot will consist of 25 consecutive test sections, except that separate lots will be established for each travel lane, unless otherwise approved by the Engineer. In addition, full width acceleration or deceleration lanes, ramps, turn lanes, and collector lanes, will be evaluated as separate lots.

If during the evaluation of the graphs, 5 lots (mainline travel lanes and full width -Y- line travel lanes greater than 300 feet in length only) require corrective action, then proceed on limited production for unsatisfactory laydown in accordance with Article 610-12. Proceeding on limited production is based upon the Design-Build Team's initial evaluation of the straightedge test results and must begin immediately upon obtaining those results. Additionally, the Engineer may direct the Design-Build Team to proceed on limited production in accordance with Article 610-12 due to unsatisfactory laydown or workmanship.

Limited production for unsatisfactory laydown is defined as being restricted to the production, placement, compaction, and final surface testing of a sufficient quantity of mix necessary to construct only 2500 feet (750 meter) of pavement at the laydown width. Once this lot is complete, the final surface testing graphs will be evaluated jointly by the Design-Build Team and the Engineer. Remain on limited production until such time as acceptable laydown results are obtained or until three consecutive 2500 foot (750 meter) sections have been attempted without achieving acceptable laydown results. The Engineer will determine if normal production may resume based upon the CSI for the limited production lot and any adjustments to the equipment, placement methods, and/or personnel performing the work. Once on limited production, the Engineer may require the Design-Build Team to evaluate the smoothness of the previous asphalt layer and take appropriate action to reduce and/or eliminate corrective measures on the final surface course. Additionally, the Design-Build Team may be required to demonstrate acceptable laydown techniques off the project limits prior to proceeding on the project.

If the Design-Build Team fails to achieve acceptable laydown results after three consecutive 2500 foot (750 meter) sections have been attempted, cease production of that mix type until such time as the cause of the unsatisfactory laydown results can be determined.

As an exception, the Engineer may grant approval to produce a different mix design of the same mix type if the cause is related to mix problem(s) rather than laydown procedures. If production of a new mix design is allowed, proceed under the limited production procedures detailed above.

After initially proceeding under limited production, the Design-Build Team shall immediately notify the Engineer if any additional lot on the project requires corrective action. The Engineer will determine if limited production procedures are warranted for continued production.

If the Design-Build Team does not operate by the limited production procedures as specified above, the 5 lots, which require corrective action, will be considered unacceptable and may be subject to removal and replacement.

The adjustment schedule for the Cumulative Straightedge Index (CSI) test results per lot is as follows:

Adjustment Schedule for Cumulative Straightedge Index (CSI) (Obtained by adding SE Index of up to 25 consecutive 100 ft. (30m) sections)		
*CSI	ACCEPTANCE CATEGORY	CORRECTIVE ACTION
0-0	Acceptable	None
1-0 or 2-0	Acceptable	None
3-0 or 4-0	Acceptable	None
Any Other Number	Unacceptable	Required

***Either Before or After Corrective Actions**

Correct any deviation that exceeds a 0.3 inch (7.5 mm) blanking band such that the deviation is reduced to 0.2 inches (5 mm) or less.

Corrective actions shall be performed at the Design-Build Team's expense and shall be presented for evaluation and approval by the Engineer prior to proceeding. Any corrective action performed shall not reduce the integrity or durability of the pavement which is to remain in place. Corrective action for deviation repair may consist of overlaying or removing and replacing. Scraping of the pavement with any blade type device will not be allowed as a corrective action. Provide overlays of the same type mix, full roadway width, and to the length and depth established by the Engineer. Tapering of the longitudinal edges of the overlay will not be allowed.

Take corrective actions as specified if the CSI indicates “Required” corrective action. The CSI after corrective action should meet or exceed “Acceptable” requirements.

Where corrective action is required, the test section(s) requiring corrective action will be retested, unless the Engineer directs the retesting of the entire lot.

Test sections and/or lots that are initially tested by the Design-Build Team which indicate excessive deviations such that corrective action is required, may be re-rolled with asphalt rollers

while the mix is still warm and in a workable condition, to possibly correct the problem. In this instance, reevaluation of the test section(s) must be completed within 24 hours of pavement placement and these test results will serve as the initial test results.

Areas excluded from testing by the N.C. Hearne Straightedge will be tested by using a non-mobile 10-foot (3 m) straightedge. Assure that the variation of the surface from the testing edge of the straightedge between any two contact points with the surface is not more than 1/8 inch (3 mm). Correct deviations exceeding the allowable tolerance in accordance with the corrective actions specified above, unless the Engineer permits other corrective actions.

Furnish the North Carolina Hearne Straightedge(s) necessary to perform this work. Maintain responsibility for all costs relating to the procurement, handling, and maintenance of these devices. The Department has entered into a license agreement with a manufacturer to fabricate, sell, and distribute the N.C. Hearne Straightedge. The Department's Pavement Construction Section may be contacted for the name of the current manufacturer and the approximate price of the straightedge.

TYING PROPOSED CONCRETE PAVEMENT TO EXISTING CONCRETE PAVEMENT

7-1-95

DB7 R05

Tie proposed concrete pavement on this project to existing concrete pavement in accordance with the detail shown in the plans and the following provision:

1. Drill holes in the existing concrete pavement 1/8" greater than the diameter of the dowel bar. After drilling, blow the hole out with air and allow to dry.
2. Next, place the cement grout or epoxy resin in the back of the dowel hole. The placement of grout can be achieved by using a flexible tube with a long nose that places the material in the back of the dowel hole; the placement of epoxy-type materials can be achieved by using a cartridge with a long nozzle that dispenses the material to the rear of the dowel hole.
3. Insert the dowel into the hole with a slight twisting motion so that the material in the back of the hole is forced up and around the dowel bar to ensure a uniform coating of the anchoring material over the dowel bar.
4. Place a thin nylon or plastic grout retention disk, (1/16" minimum thickness) manufactured to slip tightly over the dowel over the dowel and against the slab face to prevent the anchoring material from flowing out of the hole, and to create an effective face at the entrance of the dowel hole.

CONCRETE PAVEMENTS AND SHOULDERS

(08-24-09)

DB7 R20

Revise the 2006 *Standard Specifications for Roads and Structures* as follows:

SECTION 700 GENERAL REQUIREMENT FOR PORTLAND CEMENT CONCRETE PAVING

Page 7-1, Article 700-3 Concrete Hauling Equipment, delete the fourth paragraph and substitute the following:

For concrete hauled in a transit mix (ready mix) truck, use Table 1000-2 to determine the maximum elapsed time. For concrete hauled in other equipment, minimize the elapsed time to be 60 minutes or less, unless otherwise approved. The elapsed time is defined as the period from first contact between mixing water and cement until the entire operation of placing and finishing up to micro-surfacing, including corrective measures if necessary, has been completed.

Page 7-2, Article 700-4 Preparation of Subgrade and Base, fourth paragraph, delete the 3rd and 4th sentence and substitute the following:

Set pins at a distance no farther than 50 feet apart. When located on a vertical curve, set pins no farther than 25 feet apart.

Page 7-3, Article 700-5 (A)(4), delete the 2nd paragraph and substitute the following:

Where additional pavement, aggregate or soil must be placed adjacent to new pavement by machine methods, do not place it until the concrete has attained a flexural strength of at least 450 psi.

Page 7-5, Article 700-7 Finishing, insert the following as the second sentence.

The use of excessive water for finishing will not be allowed

Page 7-5, Subarticle 700-8(C) Hot Weather, 1st sentence

Substitute 90°F for 80°F.

Page 7-7, 700-11(A) General, delete the fourth paragraph and substitute the following:

Immediately after sawing the joint to the dimensions shown on the plans, completely remove the resulting slurry from the joint. Immediately reapply curing membrane following the sawing operation to damaged areas in the vicinity of the joint.

(G) Verification of Dowel Bar Alignment

Use either properly secured dowel baskets or a dowel bar inserter, provided the ability to correctly locate and align the dowels at the joints is demonstrated as described below.

Provide a calibrated magnetic imaging device that will document dowel bar location and alignment. Utilize this device as a process control and make necessary adjustment to ensure the dowels are placed in the correct location.

Scan at least 25% percent of the joints in the initial placement or 1.0 mile of pavement, whichever is greater, at random intervals throughout the pavement each time the paving train is mobilized.

Scan all joints in this initial section if the dowel bars exhibit side shift, horizontal displacement, vertical displacement, horizontal misalignment, or vertical misalignment, above the allowable tolerances defined below. In addition, continue scanning 25% of the joints until it is established that the dowel bar inserter or secured dowel basket assemblies are consistently placing the dowel bars at the correct location (meeting the tolerances defined below). Once the engineer determines that consistency is established, the contractor may reduce the percentage of scanned joints to 10%. At any time, inconsistency in the placement of the dowel bars become evident, additional scanning may be required up to 100% of the joints.

If consistency of the proper dowel bar alignment cannot be established within a reasonable time frame, the Engineer will have the option of suspending the paving operation.

Provide a report of the scanned joints. The report should include the station and lane of the joint scanned, as well as the horizontal location, depth, horizontal and vertical misalignment, and lateral displacement (side shift) of each dowel bar in the joint. The joint score described below should also be provided in the report.

Side shift is defined as the position of the center of the dowel bar in relation to the sawed joint. The maximum allowable side shift is 2 inches.

Horizontal displacement is defined as difference in the actual dowel bar location from its theoretical position as detailed in the standard details. The maximum allowable horizontal displacement is 2 inches.

Vertical displacement (depth) is the difference in the actual dowel bar location from the theoretical midpoint of the slab. The maximum allowable vertical displacement depth is 1/2 inch.

Dowel bar misalignment is defined as the difference in position of the dowel bar ends with respect to each other. Vertical misalignment is measured in the vertical axis whereas horizontal misalignment is measured in the horizontal axis.

Determine a joint score for each joint scanned. The joint score is a measure of combined effects of horizontal and vertical misalignment. The joint score is determined by summing the product of the weight (shown in the table below) and the number of bars in each misalignment category and adding 1. The vertical and horizontal dowel misalignment should be evaluated and the greater misalignment shall be utilized in determining the joint score.

Misalignment Category, mm	Weight
$0 \leq d \leq 15$	0
$15 < d \leq 20$	2
$20 < d \leq 25$	4
$25 < d \leq 38$	5
$38 \leq d$	10

where d is the individual dowel bar misalignment.

A joint that has a joint score of 10 or greater will be considered locked.

Identify any scanned joints where the opposing horizontal or vertical misalignment of any two bars within the joint exceeds 1 inch. This situation will be considered a locked joint.

When a locked joint as defined above is discovered, scan the two joints immediately adjacent to the locked joint. If either of the adjacent joints are deemed to be locked, provide a written proposal to address the dowel misalignment for each locked joint. No corrective action should be performed without written approval.

Any and all corrective action necessitated by improper joint alignment shall be at no cost to the Department.

Page 7-11, Subarticle 700-15(F), Thickness, replace the first paragraph with the following:

The thickness of the pavement will be determined by measurement of cores in accordance with AASHTO T 148.

**SECTION 710
CONCRETE PAVEMENT**

Page 7-12, Article 710-1 Description, 1st sentence

Insert *verifying dowel bar alignment*; after the words *sealing joints*;

Page 7-13, Article 710-6 Finishing, insert the following at the end of the 6th paragraph.

Provide a textured surface with an average texture depth of 0.8 mm as tested in accordance with ASTM E 965 (*Test Method for Measuring Pavement Macrot texture Depth Using a Sand Volumetric Technique*) with no single test having a texture depth of 0.5 mm or less. Perform four randomly located tests in accordance with ASTM E 965 within the initial pavement lot of each mobilization and provide test results to the Engineer. A lot is defined in Article 710-4. If the average of the four tests does not meet the above criteria, make appropriate changes to the surface texture operations and test the next lot as detailed above. Once the surface texture process is established to meet minimum texture requirements, maintain consistency within the operation to provide the above minimum texture depth. Perform additional sand patch tests in accordance with ASTM E 965 when directed.

Should the surface texture become damaged or reduced by rain, grinding or any other action, reestablish or restore surface texture by an approved method.

Page 7-15, Article 710-9 Thickness Tolerances, delete the 4th and 5th paragraph and substitute with the following:

When the measurement of the core from a lot is not deficient more than 0.2" from the plan thickness, full payment will be made. When such measurement is deficient by more than 0.2" from the plan thickness, take 2 additional cores at random within the lot and determine the average of the 3 cores. In determining the average thickness of the pavement, the Engineer will use all 3 core measurements with the exception that measurements which are in excess of the plan thickness by more than 0.2" will be considered as the plan thickness plus 0.2" and measurements which are deficient of the plan thickness by more than 1.0" will be considered as the plan thickness minus 1.0 inch. Measurements which are less than the plan thickness by more than 1.0" will not be included in the average. If the average measurement of these 3 cores is not deficient more than 0.2" from the plan thickness, full payment will be made. If the average measurement of the 3 cores is deficient more than 0.2" but not more than 1.0" from the plan thickness, an adjusted unit price in accordance with Subarticle 710-10(B) will be paid for the lot represented.

When the measurement of any core is less than the plan thickness by more than 1.0", the actual thickness of the pavement in this area will be determined by taking additional cores at not less than 10 foot intervals parallel to the center line in each direction from the affected location until in each direction a core is found which is not deficient by more than 1.0 inch. Exploratory cores for deficient thickness will not be used in averages for adjusted unit price.

Patch all core holes within 72 hours of taking the core, using a Department approved nonshrink grout compatible with the pavement concrete. Areas found deficient in thickness by more than 1.0" will be removed full lane width and replaced with concrete of the thickness shown on the plans. Any full width repairs to the concrete pavement must be performed in accordance with the *North Carolina Department of Transportation Partial and Full Depth Repair Manual* and not be less than 1/2 of the panel length (7.5 feet).

Page 7-17, Article 710-10 (C) Measurement and Payment, Substitute the following equation for the pay factor calculation:

$$\text{Pay Factor (\%)} = 100 - [650 - \text{PSI}]$$

(pay factor rounded to nearest tenth of one percent)

Page 7-19, Subarticle 720-9, Thickness Tolerances, replace the first paragraph with the following:

The thickness of the shoulder will be determined by measurement of cores in accordance with AASHTO T 148.

SECTION 725

FIELD LABORATORY FOR PORTLAND CEMENT CONCRETE PAVEMENT

Page 7-21, Subarticle 725-2, General Requirements, replace with the following:

Furnish and maintain for the exclusive use of the Engineer a field office and laboratory in which to house and use all testing equipment needed. Provide a field office that is dust and water tight, floored, and has an adequate foundation so as to prevent excessive floor movement. Provide a field office that contains 6 or more 110 volt electrical double outlets properly grounded and spaced; a telephone; at least 2 windows, satisfactory locks on all doors and windows; adequate lighting, heating, and air conditioning; sink; running water to sink; and satisfactory exhaust fan. Provide a field office that meets the following approximate minimum requirements: 200 square feet of floor space; 10 feet interior width; 6 feet 6 inches interior height; 20 square feet of counter space, 2.5 to 3 feet high and 2 feet deep with cabinets or drawers below the counter top; and 6 square feet of desk space not enclosed with cabinets. Locate the office in a position that will permit full view of the plant from the interior of the office. At or near the office, furnish toilet facilities, with waste disposal, available for use of the Department personnel. Maintain these toilets in a neat and clean condition.

Provide a laboratory trailer adjacent to the field office that is at least 400 square feet in area, approximately 20 feet wide, 20 feet long, and 7 feet in height. Provide a laboratory trailer that contains 6 or more 110 volt electrical double outlets properly grounded and spaced; satisfactory locks on all doors and windows; adequate lighting, heating, and air conditioning; sink; running water to sink; and satisfactory exhaust fans. Provide two workbenches that are approximately 10 feet long, 2 feet wide, and 2.5 feet high. One workbench shall be installed inside the trailer and the other across the end of the trailer. Provide a shelter or roof over the outside workbench to provide protection from weather. Provide, in the laboratory, an adequate number of water

storage tanks to hold all acceptance beams and any additional beams made for the purpose of determining early strengths. Construct the water storage tanks of non-corroding materials and have requirements for automatic control of the water temperature. Maintain the water in the tank at a temperature of $73^{\circ}\text{ F} \pm 3^{\circ}\text{ F}$. Equip each tank with a recording thermometer with its bulb located in the water. Provide sufficient tank volume to maintain all beams, stored with the long axis vertical, in a fully submerged condition for the duration of the required curing period. Furnish a wooden mixing board at least 3/4 inch thick and approximately 4 feet wide and 4 feet long, that is covered on one side with sheet metal of at least 22 gage, at the shelter. Provide facilities to maintain the test beams at temperature between 60° F and 80° F during initial curing.

GUARDRAIL ANCHOR UNITS, TYPE M-350

(4/20/04)

DB8 R60

Description

Furnish and install guardrail anchor units in accordance with the details in the plans, the applicable requirements of Section 862 of the 2006 *Standard Specifications for Roads and Structures*, and at locations shown in the plans.

Materials

The Design Build Team may, at his option, furnish any one of the following guardrail anchor units.

The guardrail anchor unit (SRT-350) as manufactured by:

TRINITY INDUSTRIES, INC.
2525 N. STEMMONS FREEWAY
DALLAS, TEXAS 75207
TELEPHONE: 800 644-7976

The guardrail anchor unit (FLEAT) as manufactured by:

ROAD SYSTEMS, INC.
3616 OLD HOWARD COUNTY AIRPORT
BIG SPRINGS, TEXAS 79720
TELEPHONE: 915-263-2435

The guardrail anchor unit (REGENT) as manufactured by:

ENERGY ABSORPTION SYSTEMS, INC.
ONE EAST WACKER DRIVE
CHICAGO, ILLINOIS 60601-2076
TELEPHONE: 888-32-ENERGY

Prior to installation the Design Build Team shall submit to the Engineer:

1. FHWA acceptance letter for each guardrail anchor unit certifying it meets the requirements of NCHRP Report 350, Test Level 3, in accordance with Section 106-2 of the 2006 *Standard Specifications for Roads and Structures*.
2. Certified working drawings and assembling instructions from the manufacturer for each guardrail anchor unit in accordance with Section 105-2 of the 2006 *Standard Specifications for Roads and Structures*.

No modifications shall be made to the guardrail anchor unit without the express written permission from the manufacturer. Perform installation in accordance with the details in the plans, and details and assembling instructions furnished by the manufacturer.

Construction

Guardrail end delineation is required on all approach and trailing end sections for both temporary and permanent installations. Guardrail end delineation consists of yellow reflective sheeting applied to the entire end section of the guardrail in accordance with Section 1088-3 of the 2006 *Standard Specifications for Roads and Structures* and is incidental to the cost of the guardrail anchor unit.

GUARDRAIL ANCHOR UNITS, TYPE 350

(4/20/04)

DB8 R65

Description

Furnish and install guardrail anchor units in accordance with the details in the plans, the applicable requirements of Section 862 of the 2006 *Standard Specifications for Roads and Structures*, and at locations shown in the plans.

Materials

The Design-Build Team may at his option, furnish any one of the guardrail anchor units.

Guardrail anchor unit (ET-2000) as manufactured by:

TRINITY INDUSTRIES, INC.
2525 N. STEMMONS FREEWAY
DALLAS, TEXAS 75207
TELEPHONE: 800-644-7976

The guardrail anchor unit (SKT 350) as manufactured by:

ROAD SYSTEMS, INC.
3616 OLD HOWARD COUNTY AIRPORT
BIG SPRING, TEXAS 79720
TELEPHONE: 915 263-2435

Prior to installation the Design-Build Team shall submit to the Engineer:

1. FHWA acceptance letter for each guardrail anchor unit certifying it meets the requirements of NCHRP Report 350, Test Level 3, in accordance with Section 106-2 of 2006 *Standard Specifications for Roads and Structures*.
2. Certified working drawings and assembling instructions from the manufacturer for each guardrail anchor unit in accordance with Section 105-2 of the 2006 *Standard Specifications for Roads and Structures*.

No modifications shall be made to the guardrail anchor unit without the express written permission from the manufacturer. Perform installation in accordance with the details in the plans, and details and assembling instructions furnished by the manufacturer.

Construction

Guardrail end delineation is required on all approach and trailing end sections for both temporary and permanent installations. Guardrail end delineation consists of yellow reflective sheeting applied to the entire end section of the guardrail in accordance with Section 1088-3 of the 2006 *Standard Specifications for Roads and Structures* and is incidental to the cost of the guardrail anchor unit.

IMPACT ATTENUATOR UNITS, TYPE 350

(4/20/04) (Rev. 7-18-06)

DB8 R75

Description

Furnish and install impact attenuator units and any components necessary to connect the impact attenuator units in accordance with the manufacturer's requirement, the details in the plans and at locations shown in the plans.

Materials

NON-GATING IMPACT ATTENUATOR UNITS:

The impact attenuator unit (QUADGUARD) as manufactured by:

ENERGY ABSORPTION SYSTEMS, INC.
ONE EAST WACKER DRIVE
CHICAGO, ILLINOIS 60601-2076
TELEPHONE: 312-467-6750

The impact attenuator unit (TRACC) as manufactured by:

TRINITY INDUSTRIES, INC.
2525 N. STEMMONS FREEWAY
DALLAS, TEXAS 75207

TELEPHONE: 1-800-644-7976

GATING IMPACT ATTENUATOR UNITS:

The impact attenuator unit (BRAKEMASTER) as manufactured by:

ENERGY ABSORPTION SYSTEMS, INC.
ONE EAST WACKER DRIVE
CHICAGO, ILLINOIS 60601-2076
TELEPHONE: 312-467-6750

The impact attenuator unit (CAT) as manufactured by:

TRINITY INDUSTRIES, INC.
2525 N. STEMMONS FREEWAY
DALLAS, TEXAS 75207
TELEPHONE: 1-800-644-7976

Prior to installation the Design-Build Team shall submit to the Engineer:

1. FHWA acceptance letter for each impact attenuator unit certifying it meets the requirements of NCHRP Report 350, Test Level 3, in accordance with Section 106-2 of the 2006 *Standard Specifications for Roads and Structures*.
2. Certified working drawings and assembling instructions from the manufacturer for each impact attenuator unit in accordance with Section 105-2 of the 2006 *Standard Specifications for Roads and Structures*.

No modifications shall be made to the impact attenuator unit without the express written permission from the manufacturer. Perform installation in accordance with the details in the plans, and details and assembling instructions furnished by the manufacturer.

Construction Methods

If the median width is 40 feet or less, the Design-Build Team shall supply one of the NON-GATING Impact Attenuator Units listed in the Materials Section herein.

If the median width is greater than 40 feet, the Design-Build Team may use any of the GATING or NON-GATING Impact Attenuator Units listed in the Materials Section herein.

FENCE
(3-6-06)

DB8 R86

Revise the 2006 *Standard Specifications for Roads and Structures* as follows:

Page 8-54, Subarticle 866-3(A), second sentence,

Add *existing fencing* after stumps

PREFORMED SCOUR HOLE WITH LEVEL SPREADER APRON
(08-24-09)

DB8 R105

Description

Construct and maintain preformed scour holes with spreader aprons at the locations shown on the plans and in accordance with the details in the plans. Work includes excavation, shaping and maintaining the hole and apron, furnishing and placing filter fabric, rip rap (class as specified in the plans) and permanent soil reinforcement matting.

Materials

Item	Section
Plain rip rap	1042
Filter Fabric	1056

The permanent soil reinforcement matting shall be permanent erosion control reinforcement mat and shall be constructed of synthetic or a combination of coconut and synthetic fibers evenly distributed throughout the mat between a bottom UV stabilized netting and a heavy duty UV stabilized top net. The matting shall be stitched together with UV stabilized polypropylene thread to form a permanent three dimensional structure. The mat shall have the following minimum physical properties:

<i>Property</i>	<i>Test Method</i>	<i>Value Unit</i>
Light Penetration	ASTM D6567	9 %
Thickness	ASTM D6525	0.40 in
Mass Per Unit Area	ASTM D6566	0.55 lb/sy
Tensile Strength	ASTM D6818	385 lb/ft
Elongation (Maximum)	ASTM D6818	49 %
Resiliency	ASTM D1777	>70 %
UV Stability *	ASTM 4355	≥80 %
Porosity (Permanent Net)	ECTC Guidelines	≥85 %
Maximum Permissible Shear Stress (Vegetated)	Performance Bench Test	≥8.0 lb/ft ²
Maximum Allowable Velocity (Vegetated)	Performance Bench Test	≥16.0 ft/s

*ASTM D1682 Tensile Strength and % strength retention of material after 1000 hours of exposure.

A certification (Type 1, 2, or 3) from the manufacturer showing:

- (A) the chemical and physical properties of the mat used, and
- (B) conformance of the mat with this specification will be required.

Construction Methods

All areas to be protected with the mat shall be brought to final grade and seeded in accordance with Section 1660 of the *Standard Specifications*. The surface of the soil shall be smooth, firm, stable and free of rocks, clods, roots or other obstructions that would prevent the mat from lying in direct contact with the soil surface. Areas where the mat is to be placed will not need to be mulched.

STREET SIGNS AND MARKERS AND ROUTE MARKERS

(7-1-95)

DB9 R01

Move any existing street signs, markers, and route markers out of the construction limits of the project and install the street signs and markers and route markers so that they will be visible to the traveling public if there is sufficient right of way for these signs and markers outside of the construction limits.

Near the completion of the project and when so directed by the Engineer, move the signs and markers and install them in their proper location in regard to the finished pavement of the project.

Stockpile any signs or markers that cannot be relocated due to lack of right of way, or any signs and markers that will no longer be applicable after the construction of the project, at locations directed by the Engineer for removal by others.

The Design-Build Team shall be responsible to the owners for any damage to any street signs and markers or route markers during the above described operations.

STEEL U-CHANNEL POSTS

(7-18-06)

DB9 R02

Amend the 2006 *Standard Specifications for Roads and Structures* as follows:

Page 9-15 Subarticle 903-3(D) first paragraph, last sentence, delete the last sentence and add the following:

Use posts of sufficient length to permit the appropriate sign mounting height. Spliced posts are not permitted on new construction.

SHIPPING SIGNS

(5-15-07)

DB9 R03

Revise the 2006 *Standard Specifications for Roads and Structures* as follows:

Page 9-2, Section 901-3(A), General, add the following as the 7th paragraph:

Ship all multi-panel signs to the project intact, completely assembled and ready to be hung. Fabricate signs taller than 12 feet as 2 separate signs with a horizontal splice, ready to be spliced and hung. No assembly other than a horizontal splice will be permitted.

GALVANIZED HIGH STRENGTH BOLTS, NUTS AND WASHERS

(2-17-09)

DB10 R02

Revise the 2006 *Standard Specifications* as follows:

Page 10-126, Subarticle 1072-7(F)(3) Change the AASHTO reference to B 695 Class 55

Page 10-247, Table 1092-2, Steel Sign Materials, Change High Strength Bolts, Nuts & Washers ASTM Specifications for Galvanizing to B695 Class 55.

Page 10-259, Subarticle 1094-1(A) Breakaway or Simple Steel Beam Sign Supports, replace the third paragraph with the following:

Fabricate high strength bolts, nuts, and washers required for breakaway supports from steel in accordance with ASTM A325 and galvanize in accordance with AASHTO B 695 Class 55.

Page 10-261, Article 1096-2 Steel Overhead Sign Structures, replace the last sentence with the following:

The galvanizing shall meet the requirement of AASHTO B 695 Class 55 for fasteners and of ASTM A123 for other structural steel.

AGGREGATE PRODUCTION

(11-20-01)

DB10 R05

Provide aggregate from a producer who utilizes the new Aggregate Quality Control / Quality Assurance Program that is in effect at the time of shipment.

No price adjustment is allowed to Design-Build Team or producers who utilize the new program. Participation in the new program does not relieve the producer of the responsibility of complying with all requirements of the 2006 *Standard Specifications for Roads and Structures*. Copies of this procedure are available upon request from the Materials and Test Unit.

CONCRETE BRICK AND BLOCK PRODUCTION

(11-20-01)

DB10 R10

Provide concrete brick and block from a producer who utilizes the new Solid Concrete Masonry Brick / Unit Quality Control / Quality Assurance Program that is in effect on the date that material is received on the project.

No price adjustment is allowed to Design-Build Team or producers who utilize the new program. Participation in the new program does not relieve the producer of the responsibility of complying with all requirements of the 2006 *Standard Specifications for Roads and Structures*. Copies of this procedure are available upon request from the Materials and Test Unit.

PORTLAND CEMENT CONCRETE (Alkali-Silica Reaction)

(2-20-07)

DB10 R16

Revise the 2006 *Standard Specifications for Roads and Structures* as follows:

Article 1024-1(A), replace the 2nd paragraph with the following:

Certain combinations of cement and aggregate exhibit an adverse alkali-silica reaction. The alkalinity of any cement, expressed as sodium-oxide equivalent, shall not exceed 1.0 percent. For mix designs that contain non-reactive aggregates and cement with an alkali content less than 0.6%, straight cement or a combination of cement and fly ash, cement and ground granulated blast furnace slag or cement and microsilica may be used. The pozzolan quantity shall not exceed the amount shown in Table 1024-1. For mixes that contain cement with an alkali content between 0.6% and 1.0%, and for mixes that contain a reactive aggregate documented by the Department, regardless of the alkali content of the cement, use a pozzolan in the amount shown in Table 1024-1.

Obtain the list of reactive aggregates documented by the Department at:

<http://www.ncdot.org/doh/operations/materials/pdf/quarryasrprob.pdf>

<i>Pozzolan</i>	<i>Rate</i>
Class F Fly Ash	20% by weight of required cement content, with 1.2 lbs Class F fly ash per lb of cement replaced
Ground Granulated Blast Furnace Slag	35%-50% by weight of required cement content with 1 lb slag per lb of cement replaced
Microsilica	4%-8% by weight of required cement content, with 1 lb microsilica per lb of cement replaced

GLASS BEADS

(7-18-06)

DB10 R35

Revise the 2006 *Standard Specifications for Roads and Structures* as follows:

Page 10-223, 1087-4(C) Gradation & Roundness

Replace the second sentence of the first paragraph with the following:

All Drop-On and Intermixed Glass Beads shall be tested in accordance with ASTM D1155.

Delete the last paragraph.

ENGINEERING FABRICS TABLE 1056-1

(7-18-06)

DB10 R40

Revise the 2006 *Standard Specifications for Roads and Structures* as follows:

Page 10-100, Table 1056-1, replace the values for Trapezoidal Tear Strength with the following:

Physical Property	ASTM Test Method	Type 1	Type 2	Type 3		Type 4
				Class A	Class B	
Typical Applications		Shoulder Drain	Under Riprap	Temporary Silt Fence	Soil Stabilization	
Trapezoidal Tear Strength	D4533	45 lb	75 lb	--	--	75 lb

QUALIFICATION OF WELDS AND PROCEDURES

(6-3-09)

DB 10 R43

Page 10-143, Subarticle 1072-20(D) Qualification of Welds and Procedures, replace the third sentence of the first paragraph with the following:

For all prequalified field welds, submit Welding Procedure Specifications (WPS) for each joint configuration for approval at least 30 days prior to performing any welding. In lieu of this, use the WPS provided and preapproved by the Department. These preapproved WPS are available from the Materials and Tests Unit or at:

http://www.ncdot.org/doh/operations/materials/structural/appr_proc.html.

Use non-prequalified welds only if approved by the Engineer. Submit WPS for all non-prequalified welds to the Engineer for approval. At no cost to the Department, demonstrate their adequacy in accordance with the requirements of the Bridge Welding Code.

PAIN T SAMPLING AND TESTING

(8-15-06)

DB10 R 45

Revise the 2006 *Standard Specifications for Roads and Structures* as follows:

Page 10-190, Article 1080-4, Delete the first paragraph and replace with the following:

All paint will be sampled, either at the point of manufacture or at the point of destination. Inspection and sampling will be performed at the point of manufacture wherever possible. The Design-Build Team shall not begin painting until the analysis of the paint has been performed, and the paint has been accepted.

PORTABLE CONCRETE BARRIER

(2-20-07)

DB10 R50

The 2006 *Standard Specifications for Roads and Structures* is revised as follows:

Page 10-245, Article 1090-1(A) General, add the following after the first sentence:

The requirement for approved galvanized connectors will be waived if the barrier remains the property of the Design-Build Team.

TEMPORARY SHORING

(09/25/07)

DB11 R02

Description

Design and construct temporary shoring in accordance with the contract. Temporary shoring includes standard shoring, temporary mechanically stabilized earth (MSE) walls and non-anchored temporary shoring. Trench boxes are not considered temporary shoring. "Standard shoring" refers to *standard temporary shoring* and *standard temporary MSE walls*. Notes on plans may restrict the use of one or both types of standard shoring. Notes on plans may also require or prohibit temporary MSE walls.

Unless noted otherwise on the plans, temporary shoring is required as shown on the plans and to maintain traffic. Temporary shoring to maintain traffic is defined as shoring necessary to provide lateral support to the side of an excavation or embankment parallel to an open travelway when a theoretical 2:1 (H:V) slope from the bottom of the excavation or embankment intersects the existing ground line closer than 5 feet from the edge of pavement of the open travelway.

This provision is not applicable to anchored temporary shoring or the installation of pipes, drop inlets and utilities unless noted otherwise on the plans. Provide all shoring submittals before beginning work.

Materials

(A) Certifications, Storage and Handling

Provide Type 7 Contractor's Certifications in accordance with Article 106-3 of the 2006 *Standard Specifications for Roads and Structures* for all shoring materials used with the exception of reinforcing fabrics and geogrids. Furnish Type 2 Typical Certified Mill Test Reports in accordance with Article 106-3 of the 2006 *Standard Specifications for Roads and Structures* for all seam strengths and reinforcing fabric and geogrid properties. Provide minimum average roll values (MARV) in accordance with ASTM D4759 for test reports. For testing reinforcing fabric and geogrids, a lot is defined as a single day's production.

Load, transport, unload and store shoring materials such that they are kept clean and free of damage. Identify, store and handle all geogrids and geotextile fabrics in accordance with ASTM D4873. Geogrids and fabrics with defects, flaws, deterioration or damage will be rejected. Do not leave fabrics or geogrids uncovered for more than 7 days.

(B) Shoring Backfill

Use shoring backfill for the construction of all temporary shoring including backfilling behind non-anchored temporary shoring and in the reinforced zone for temporary MSE walls. Unless backfilling around culverts, use shoring backfill that meets the requirements of Class II Type I, Class III, Class V or Class VI select material in accordance with Section 1016 of the 2006 *Standard Specifications for Roads and Structures* or AASHTO M145 for soil classification A-2-4 with a maximum plasticity index (PI) of 6. For backfilling around culverts, use shoring backfill as defined herein except for A-2-4 soil.

(C) Non-anchored Temporary Shoring

Use steel shapes, plates and piles that meet the requirements of ASTM A36 and steel sheet piles that meet the requirements of Article 1084-2 of the 2006 *Standard Specifications for Roads and Structures*. Use timber lagging with a minimum allowable bending stress of 1000 psi that meets the requirements of Article 1082-1 of the 2006 *Standard Specifications for Roads and Structures*. For standard temporary shoring, use pile sections and lengths and lagging sizes as shown on the plans.

(D) Temporary MSE Walls

Use welded wire reinforcement forms, facings, mesh and mats that meet the requirements of AASHTO M55 or M221. Use connector bars and wires for welded wire wall components and support struts that meet the requirements of AASHTO M32. For standard temporary MSE walls, use wire gauges, strut sizes and welded wire components as shown on the plans.

(1) Geotextile Fabrics

Use geotextile fabrics that meet the requirements of Article 1056-1 of the 2006 *Standard Specifications for Roads and Structures*.

(a) Reinforcing Fabric

The reinforcement direction (RD) is defined as the direction perpendicular to the wall face and the cross-reinforcement direction (CRD) is defined as the direction parallel to the wall face.

Use woven polyester or polypropylene fabric that meets the following properties:

Property	Test Method	Requirement (MARV)
Wide Width Tensile Strength @ Ultimate (RD)	ASTM D4595	Varies – 200 lb/in min
Wide Width Tensile Strength @ Ultimate (CRD)	ASTM D4595	100 lb/in min
Trapezoidal Tear Strength	ASTM D4533	100 lb min
CBR Puncture Strength	ASTM D6241	600 lb min
UV Resistance after 500 hrs	ASTM D4355	70 %
Apparent Opening Size (AOS), US Sieve	ASTM D4751	20 min – 70 max
Permittivity	ASTM D4491	0.20 sec ⁻¹

For standard temporary MSE walls (temporary fabric wall) use reinforcing fabric wide width tensile strengths and lengths in the RD as shown on the plans.

(b) Retention Fabric

Retain shoring backfill at the face of temporary MSE walls with retention fabric. Use fabric that meets the requirements of Class 3 and the UV resistance, AOS and permittivity for separation geotextile in accordance with AASHTO M288.

(2) SierraScape Temporary Wall

Use uniaxial (UX) geogrids composed of high-density polyethylene (HDPE) manufactured by Tensar Earth Technologies. Test geogrids in accordance with ASTM D6637. Use connection rods manufactured by Tensar Earth Technologies to transfer the load between the facings and geogrids.

For standard temporary MSE walls (SierraScape temporary wall) use geogrid types and lengths as shown on the plans.

(3) Terratrel Temporary Wall

Use ribbed reinforcing steel strips manufactured by The Reinforced Earth Company that meet the requirements of ASTM A572, Grade 65. Use connector rods that meet the requirements of AASHTO M31, Grade 60 and hair pin connectors that meet the requirements of ASTM A1011, Grade 50. Use bolts, nuts and washers that meet the requirements of AASHTO M164.

For standard temporary MSE walls (Terratrel temporary wall) use ribbed steel strip size and lengths, rod lengths and diameters, hairpin connectors, bolts, nuts and washers as shown on the plans.

Embedment

“Embedment” is defined as the depth of shoring below the bottom of the excavation or the grade in front of the shoring. For cantilever shoring, embedment is the depth of the piling below the grade in front of the shoring. For temporary MSE walls, embedment is the difference between the grade elevation in front of the wall and the elevation of the bottom of the reinforced zone.

Portable Concrete Barriers

Provide portable concrete barriers in accordance with the plans and if shoring is located within the clear zone as defined in the *AASHTO Roadside Design Guide*. Use NCDOT portable concrete barriers (PCBs) in accordance with Roadway Standard Drawing No. 1170.01 and Section 1170 of the 2006 *Standard Specifications for Roads and Structures*. Use Oregon Tall F-Shape Concrete Barriers in accordance with detail drawing and special provision obtained from:

<http://www.ncdot.org/doh/preconstruct/wztc/DesRes/English/DesResEng.html>

The clear distance is defined as the horizontal distance from the back face of the barrier to the edge of pavement and the minimum required clear distance is shown on the traffic control plans. At the Contractor’s option or if the minimum required clear distance is not available, set an unanchored PCB against the traffic side of the shoring and design shoring for traffic impact or use the “surcharge case with traffic impact” for the standard temporary shoring. An anchored PCB or Oregon barrier is required for barriers above and behind temporary MSE walls.

Contractor Designed Shoring

“Contractor designed shoring” is defined as non-anchored temporary shoring or temporary MSE walls designed by the Contractor. Unless prohibited or required, Contractor designed shoring is optional. Contractor designed shoring is required when notes on plans prohibit the use of standard shoring. Non-anchored Contractor designed shoring is prohibited when notes on plans require the use of temporary MSE walls and Contractor designed temporary MSE walls are prohibited when notes on plans prohibit the use of temporary MSE walls.

Before beginning design, survey the shoring location to determine existing elevations and actual design heights. Submit design calculations and drawings including typical sections for review and acceptance showing details of the proposed design and construction sequence in accordance with Article 105-2 of the 2006 *Standard Specifications for Roads and Structures*. Have shoring designed, detailed and sealed by a Professional Engineer registered in the State of North Carolina. Submit 3 hard copies of design calculations and 10 hard copies of drawings and an electronic copy (pdf or jpeg format on CD or DVD) of both the calculations and drawings.

Design non-anchored temporary shoring in accordance with the *AASHTO Guide Design Specifications for Bridge Temporary Works* and temporary MSE walls in accordance with the *AASHTO Allowable Stress Design Standard Specifications for Highway Bridges*. Use the following soil parameters for shoring backfill in the reinforced zone.

Total Unit Weight = 120 pcf
Friction Angle = 30 degrees
Cohesion = 0 psf

Design temporary shoring in accordance with the in-situ assumed soil parameters shown on the plans. Design shoring for a 3-year design service life and a traffic surcharge equal to 240 psf. This surcharge is not applicable for construction traffic. If a construction surcharge will be present within a horizontal distance equal to the height of the shoring, design the shoring for the required construction surcharge. If the edge of pavement or a structure to be protected is within a horizontal distance equal to the height of the shoring, design shoring for a maximum deflection of 3". Otherwise, design shoring for a maximum deflection of 6".

For non-anchored temporary shoring, the top of shoring elevation is defined as the elevation where the grade intersects the back face of the shoring. For traffic impact, apply 2 kips / ft to the shoring 1.5 feet above the top of shoring elevation. When designing for traffic impact, extend shoring at least 32" above the top of shoring elevation. Otherwise, extend shoring at least 6" above the top of shoring elevation.

Standard Shoring

Unless notes on plans prohibit the use of one or both types of standard shoring, standard shoring is optional. Submit a "Standard Temporary MSE Wall Selection Form" for each standard temporary MSE wall location and a "Standard Temporary Shoring Selection Form" for up to three standard temporary shoring locations. Submit selection forms at least 14 days before beginning shoring construction. Obtain standard shoring selection forms from:

<http://www.ncdot.org/doh/preconstruct/highway/geotech/formdet/standards.html>

(A) Standard Temporary Shoring

Determine the shoring height, traffic impact, groundwater condition and slope or surcharge case for each standard temporary shoring location. Determine the minimum required extension, embedment and sheet pile section modulus or H pile section from the plans for each location.

(B) Standard Temporary MSE Walls

Choose a standard temporary MSE wall from the multiple temporary MSE wall options shown in the plans. Do not use more than one option per wall location.

Step bottom of reinforced zone in increments equal to vertical reinforcement spacing for the wall option chosen. Determine the wall height and slope or surcharge case for each section of standard temporary MSE wall. With the exception of either the first or last section of wall, use horizontal section lengths in increments equal to the following for the wall option chosen.

Standard Temporary MSE Wall Option	Increment
Temporary Fabric Wall	9 ft min (varies)
Hilfiker Temporary Wall	10 ft min (varies)
SierraScape Temporary Wall	18 ft – 7 ¼ in
Retained Earth Temporary Wall	24 ft
Terratrel Temporary Wall	19 ft – 8 in

Determine the appropriate facings and / or forms and reinforcement length, spacing, strength, type, density and / or size from the plans for each wall section.

Construction Methods

When using an anchored PCB, anchor the barrier in accordance with Roadway Standard Drawing 1170.01 and Section 1170 of the 2006 *Standard Specifications for Roads and Structures*. Control drainage during construction in the vicinity of temporary shoring. Collect and direct run off away from temporary MSE walls, shoring and shoring backfill.

(A) Non-anchored Temporary Shoring

Install and interlock sheet piling or install piles as shown on the plans or accepted submittals with a tolerance of 1/2 inch per foot from vertical. Contact the Engineer if the design embedment is not achieved. If piles are placed in drilled holes, perform pile excavation to the required elevations and backfill excavations with concrete and lean sand grout.

Remove grout as necessary to install timber lagging. Install timber lagging with a minimum bearing distance of 3” on each pile flange. Backfill voids behind lagging with shoring backfill.

Perform welding in accordance with the accepted submittals and Article 1072-20 of the 2006 *Standard Specifications for Roads and Structures*.

(1) Pile Excavation

Excavate a hole with a diameter that will result in at least 3” of clearance around the entire pile. Use equipment of adequate capacity and capable of drilling through soil and non-soil including rock, boulders, debris, man-made objects and any other materials encountered. Blasting is not permitted to advance excavations. Blasting for core removal is permitted only when approved by the Engineer. Dispose of drilling spoils in accordance with Section 802 of the 2006 *Standard Specifications for Roads and Structures*. Drilling spoils consist of all excavated material including water removed from excavations by either pumping or drilling tools.

If unstable, caving or sloughing soils are encountered, stabilize excavations with clean watertight steel casing. Steel casings may be either sectional type or one continuous corrugated or non-corrugated piece. Provide casings of ample strength to withstand handling and driving stresses and the pressures imposed by concrete, earth or backfill. Use steel casings with an outside diameter equal to the hole size and a minimum wall thickness of 1/4 inch.

Before placing concrete, check the water inflow rate in the excavation after any pumps have been removed. If the inflow rate is less than 6” per half-hour, remove any water and free fall the concrete into the excavation. Ensure that concrete flows completely around the pile. If the water inflow rate is greater than 6” per half-hour, propose and obtain approval of the concrete placement procedure before placing concrete.

Center the pile in the excavation and fill the excavation with Class A concrete in accordance with Section 1000 of the 2006 *Standard Specifications for Roads and Structures* except as modified herein. Provide concrete with a slump of 6 to 8 inches. Use an approved high-range water reducer to achieve this slump. Place concrete in a continuous manner to the bottom of shoring or the elevations shown on the accepted submittals. Fill the remainder of the excavation with a lean sand grout and remove all casings.

(B) Temporary MSE Walls

The Engineer may require a wall preconstruction meeting to discuss the construction and inspection of the temporary MSE walls. If required, conduct the meeting with the Site Superintendent, the Resident or Bridge Maintenance Engineer, the Bridge Construction Engineer and the Geotechnical Operations Engineer before beginning wall construction.

Perform all necessary clearing and grubbing in accordance with Section 200 of the 2006 *Standard Specifications for Roads and Structures*. Excavate as necessary as shown on the plans or accepted submittals. Notify the Engineer when foundation excavation is complete. Do not place shoring backfill or first reinforcement layer until obtaining approval of the excavation depth and foundation material.

If applicable, install foundations located within the reinforced zone in accordance with the plans or accepted submittals.

Erect and maintain facings and forms as shown on the plans or accepted submittals. Stagger vertical joints of facings and forms to create a running bond when possible unless shown otherwise on the plans or accepted submittals.

Place facings and forms as near to vertical as possible with no negative batter. Construct temporary MSE walls with a vertical and horizontal tolerance of 3" when measured with a 10-foot straight edge and an overall vertical plumbness (batter) and horizontal alignment of less than 6".

Place reinforcement at locations and elevations shown on the plans or accepted submittals and in slight tension free of kinks, folds, wrinkles or creases. Repair or replace any damaged reinforcement. Contact the Engineer when existing or future structures such as foundations, pavements, pipes, inlets or utilities will interfere with reinforcement. To avoid structures, deflect, skew and modify reinforcement.

Do not splice reinforcement in the reinforcement direction (RD), i.e., parallel to the wall face. Seams are allowed in the cross-reinforcement direction (CRD). Bond or sew adjacent reinforcing fabric together or overlap fabric a minimum of 18" with seams oriented perpendicular to the wall face.

Place shoring backfill in 8 to 10-inch thick lifts and compact in accordance with Subarticle 235-4(C) of the 2006 *Standard Specifications for Roads and Structures*. Use only hand operated compaction equipment within 3 ft of the wall face. Do not damage reinforcement when placing and compacting shoring backfill. End dumping directly on the reinforcement is not permitted. Do not operate heavy equipment on reinforcement until it is covered with at least 10" of shoring backfill. Do not use sheepfoot, grid rollers or other types of compaction equipment with feet.

Cover reinforcing and retention fabric with at least 3" of shoring backfill. Place top reinforcement layer between 4 and 24 inches below top of wall as shown on the plans or accepted submittals.

Bench temporary MSE walls into the sides of excavations where applicable. If the top of wall is within 5 feet of finished grade, remove top form or facing and incorporate the top reinforcement layer into the fill when placing fill in front of the wall. Temporary MSE walls remain in place permanently unless required otherwise.

CHANGEABLE MESSAGE SIGNS

(11-21-06)

DB11 R 11

Revise the 2006 *Standard Specifications for Roads and Structures* as follows:

Page 11-9, Article 1120-3, Replace the 3rd sentence with the following:

Sign operator will adjust flash rate so that no more than two messages will be displayed and be legible to a driver when approaching the sign at the posted speed.

PAVEMENT MARKING LINES

(11-21-06) (Rev. 9-18-07)

DB 12 R001

Revise the 2006 *Standard Specifications for Roads and Structures* as follows:

Page 12-2, 1205-3(D) Time Limitations for Replacement, add the following at the beginning of the chart:

Facility Type	Marking Type	Replacement Deadline
Full-control-of-access multi-lane roadway (4 or more total lanes) and ramps, including Interstates	All markings including symbols	By the end of each workday's operation if the lane is opened to traffic

EXCAVATION, TRENCHING, PIPE LAYING & BACKFILLING FOR UTILITIES

(2-17-09)

DB15 R001

Revise the 2006 *Standard Specifications for Roads and Structures* as follows:

Page 15-5, Article 1505-4 Repair of Pavements, Sidewalks and Driveways, first paragraph, add at the end of the first sentence

in accordance with Section 848.

ON-THE-JOB TRAINING

(10-16-07) (Rev 6-3-09)

Z-10

Description

The North Carolina Department of Transportation will administer a custom version of the Federal On-the-Job Training (OJT) Program, commonly referred to as the Alternate OJT Program. All contractors (existing and newcomers) will be automatically placed in the Alternate Program. Standard OJT requirements typically associated with individual projects will no longer be applied at the project level. Instead, these requirements will be applicable on an annual basis for each contractor administered by the OJT Program Manager.

On the Job Training shall meet the requirements of 23 CFR 230.107 (b), 23 USC – Section 140, this provision and the On-the-Job Training Program Manual.

The Alternate OJT Program will allow a contractor to train employees on Federal, State and privately funded projects located in North Carolina. However, priority must be given to training employees on NCDOT Federal-Aid funded projects.

Minorities and Women

Developing, training and upgrading of minorities and women toward journeymen level status is a primary objective of this special training provision. Accordingly, the Contractor shall make every effort to enroll minority and women as trainees to the extent that such persons are available within a reasonable area of recruitment. This training commitment is not intended, and shall not be used, to discriminate against any applicant for training, whether a member of a minority group or not.

Assessing Training Goals

The Department through the OJT Program Manager, will assign training goals for a calendar year based on the contractors' past three years' activity and the contractors' anticipated upcoming year's activity with the Department. At the beginning of each year, all contractors eligible will be contacted by the Department to determine the number of trainees that will be assigned for the upcoming calendar year. At that time, the Contractor shall enter into an agreement with the Department to provide a self-imposed on-the-job training program for the calendar year. This agreement will include a specific number of annual training goals agreed to by both parties. The number of training assignments may range from 1 to 15 per contractor per calendar year. The Contractor shall sign an agreement to fulfill their annual goal for the year. A sample agreement is available at www.ncdot.org/business/ocs/ojt/.

Training Classifications

The Contractor shall provide on-the-job training aimed at developing full journeyman level workers in the construction craft / operator positions. Preference shall be given to providing training in the following skilled work classifications:

Equipment Operators	Office Engineers
Truck Drivers	Estimators
Carpenters	Iron / Reinforcing Steel Workers
Concrete Finishers	Mechanics
Pipe Layers	Welders

The Department has established common training classifications and their respective training requirements that may be used by the contractors. However, the classifications established are not all-inclusive. Where the training is oriented toward construction applications, training will be allowed in lower-level management positions such as office engineers and estimators. Contractors shall submit new classifications for specific job functions that their employees are

performing. The Department will review and recommend for acceptance to FHWA the new classifications proposed by contractors, if applicable. New classifications shall meet the following requirements:

Proposed training classifications are reasonable and realistic based on the job skill classification needs, and

The number of training hours specified in the training classification is consistent with common practices and provides enough time for the trainee to obtain journeyman level status.

The Contractor may allow trainees to be trained by a subcontractor provided that the Contractor retains primary responsibility for meeting the training and this provision is made applicable to the subcontract. However, only the Contractor will receive credit towards the annual goal for the trainee.

Where feasible, 25 percent of apprentices or trainees in each occupation shall be in their first year of apprenticeship or training. The number of trainees shall be distributed among the work classifications on the basis of the contractor's needs and the availability of journeymen in the various classifications within a reasonable area of recruitment.

No employee shall be employed as a trainee in any classification in which they have successfully completed a training course leading to journeyman level status or in which they have been employed as a journeyman.

Records and Reports

The Contractor shall maintain enrollment, monthly and completion reports documenting company compliance under these contract documents. These documents and any other information, as requested, shall be submitted to the OJT Program Manager.

Upon completion and graduation of the program, the Contractor shall provide each trainee with a certification Certificate showing the type and length of training satisfactorily completed.

Trainee Interviews

All trainees enrolled in the program shall receive an initial and Trainee / Post graduate interview conducted by the OJT program staff.

Trainee Wages

Contractors shall compensate trainees on a graduating pay scale based upon a percentage of the prevailing minimum journeyman wages (Davis-Bacon Act). Minimum pay shall be as follows:

- | | |
|------------|---|
| 60 percent | of the journeyman wage for the first half of the training period |
| 75 percent | of the journeyman wage for the third quarter of the training period |
| 90 percent | of the journeyman wage for the last quarter of the training period |

In no instance shall a trainee be paid less than the local minimum wage. The Contractor shall adhere to the minimum hourly wage rate that will satisfy both the NCDOL and the Department.

Achieving or Failing to Meet Training Goals

The Contractor will be credited for each trainee employed by him on the contract work who is currently enrolled or becomes enrolled in an approved program and who receives training for at least 50 percent of the specific program requirement. Trainees will be allowed to be transferred between projects if required by the Contractor's scheduled workload to meet training goals.

If a contractor fails to attain their training assignments for the calendar year, they may be taken off the NCDOT's Bidders List.

Measurement and Payment

No compensation will be made for providing required training in accordance with these contract documents.

STANDARD SPECIAL PROVISION

AVAILABILITY OF FUNDS – TERMINATION OF CONTRACTS

(05-20-08)

Z-2

General Statute 143C-6-11. (h) Highway Appropriation is hereby incorporated verbatim in this contract as follows:

“(h) Amounts Encumbered – Transportation project appropriations may be encumbered in the amount of allotments made to the Department of Transportation by the Director for the estimated payments for transportation project contract work to be performed in the appropriation fiscal year. The allotments shall be multiyear allotments and shall be based on estimated revenues and shall be subject to the maximum contract authority contained in *General Statute 143C-6-11(c)*. Payment for transportation project work performed pursuant to contract in any fiscal year other than the current fiscal year is subject to appropriations by the General Assembly. Transportation project contracts shall contain a schedule of estimated completion progress, and any acceleration of this progress shall be subject to the approval of the Department of Transportation provided funds are available. The State reserves the right to terminate or suspend any transportation project contract, and any transportation project contract shall be so terminated or suspended if funds will not be available for payment of the work to be performed during that fiscal year pursuant to the contract. In the event of termination of any contract, the contractor shall be given a written notice of termination at least 60 days before completion of scheduled work for which funds are available. In the event of termination, the contractor shall be paid for the work already performed in accordance with the contract specifications.”

Payment will be made on any contract terminated pursuant to the special provision in accordance with Article 108-13(E), of the *North Carolina Department of Transportation Standard Specifications for Roads and Structures*, dated July 1, 2006.

***** STANDARD SPECIAL PROVISIONS *****

NCDOT GENERAL SEED SPECIFICATIONS FOR SEED QUALITY

(11-18-08)

Z-3

Seed shall be sampled and tested by the North Carolina Department of Agriculture and Consumer Services, Seed Testing Laboratory. When said samples are collected, the vendor shall supply an independent laboratory report for each lot to be tested. Results from seed so sampled shall be final. Seed not meeting the specifications shall be rejected by the Department of Transportation and shall not be delivered to North Carolina Department of Transportation warehouses. If seed has been delivered it shall be available for pickup and replacement at the supplier's expense.

Any re-labeling required by the North Carolina Department of Agriculture and Consumer Services, Seed Testing Laboratory, that would cause the label to reflect as otherwise specified herein shall be rejected by the North Carolina Department of Transportation.

Seed shall be free from seeds of the noxious weeds Johnsongrass, Balloonvine, Jimsonweed, Witchweed, Itchgrass, Serrated Tussock, Showy Crotalaria, Smooth Crotalaria, Sicklepod, Sandbur, Wild Onion, and Wild Garlic. Seed shall not be labeled with the above weed species on the seed analysis label. Tolerances as applied by the Association of Official Seed Analysts will NOT be allowed for the above noxious weeds except for Wild Onion and Wild Garlic.

Tolerances established by the Association of Official Seed Analysts will generally be recognized. However, for the purpose of figuring pure live seed, the found pure seed and found germination percentages as reported by the North Carolina Department of Agriculture and Consumer Services, Seed Testing Laboratory will be used. Allowances, as established by the NCDOT, will be recognized for minimum pure live seed as listed on the following pages.

The specifications for restricted noxious weed seed refers to the number per pound as follows:

<u>Restricted Noxious Weed</u>	<u>Limitations per Lb. Of Seed</u>	<u>Restricted Noxious Weed</u>	<u>Limitations per Lb. of Seed</u>
Blessed Thistle	4 seeds	Cornflower (Ragged Robin)	27 seeds
Cocklebur	4 seeds	Texas Panicum	27 seeds
Spurred Anoda	4 seeds	Bracted Plantain	54 seeds
Velvetleaf	4 seeds	Buckhorn Plantain	54 seeds
Morning-glory	8 seeds	Broadleaf Dock	54 seeds
Corn Cockle	10 seeds	Curly Dock	54 seeds
Wild Radish	12 seeds	Dodder	54 seeds
Purple Nutsedge	27 seeds	Giant Foxtail	54 seeds
Yellow Nutsedge	27 seeds	Horsenettle	54 seeds
Canada Thistle	27 seeds	Quackgrass	54 seeds
Field Bindweed	27 seeds	Wild Mustard	54 seeds
Hedge Bindweed	27 seeds		

Seed of Pensacola Bahiagrass shall not contain more than 7% inert matter, Kentucky Bluegrass, Centipede and Fine or Hard Fescue shall not contain more than 5% inert matter whereas a maximum of 2% inert matter will be allowed on all other kinds of seed. In addition, all seed

shall not contain more than 2% other crop seed nor more than 1% total weed seed. The germination rate as tested by the North Carolina Department of Agriculture shall not fall below 70%, which includes both dormant and hard seed. Seed shall be labeled with not more than 7%, 5% or 2% inert matter (according to above specifications), 2% other crop seed and 1% total weed seed.

Exceptions may be made for minimum pure live seed allowances when cases of seed variety shortages are verified. Pure live seed percentages will be applied in a verified shortage situation. Those purchase orders of deficient seed lots will be credited with the percentage that the seed is deficient.

FURTHER SPECIFICATIONS FOR EACH SEED GROUP ARE GIVEN BELOW:

Minimum 85% pure live seed; maximum 1% total weed seed; maximum 2% total other crop seed; maximum 144 restricted noxious weed seed per pound. Seed less than 83% pure live seed will not be approved.

Sericea Lespedeza
Oats (seeds)

Minimum 80% pure live seed; maximum 1% total weed seed; maximum 2% total other crop; maximum 144 restricted noxious weed seed per pound. Seed less than 78% pure live seed will not be approved.

Tall Fescue (all approved varieties)	Bermudagrass
Kobe Lespedeza	Browntop Millet
Korean Lespedeza	German Millet - Strain R
Weeping Lovegrass	Clover - Red/White/Crimson
Carpetgrass	

Minimum 78% pure live seed; maximum 1% total weed seed; maximum 2% total other crop seed; maximum 144 restricted noxious weed seed per pound. Seed less than 76% pure live seed will not be approved.

Common or Sweet Sundangrass

Minimum 76% pure live seed; maximum 1% total weed seed; maximum 2% total other crop seed; maximum 144 restricted noxious weed seed per pound. Seed less than 74% pure live seed will not be approved.

Rye (grain; all varieties)
Kentucky Bluegrass (all approved varieties)
Hard Fescue (all approved varieties)
Shrub (bicolor) Lespedeza

Minimum 70% pure live seed; maximum 1% total weed seed; maximum 2% total other crop seed; maximum 144 restricted noxious weed seed per pound. Seed less than 70% pure live seed will not be approved.

Centipedegrass
Crownvetch
Pensacola Bahiagrass

Japanese Millet
Reed Canary Grass
Zoysia

Minimum 70% pure live seed; maximum 1% total weed seed; maximum 2% total other crop seed; maximum 5% inert matter; maximum 144 restricted noxious weed seed per pound.

Barnyard Grass
Big Bluestem
Little Bluestem
Bristly Locust
Birdsfoot Trefoil
Indiangrass
Orchardgrass
Switchgrass
Yellow Blossom Sweet Clover

*** STANDARD SPECIAL PROVISIONS ***

ERRATA

(07-21-09)

Z-4

Revise the *Standard Specifications for Roads and Structures July 2006* on all projects as follows:

Division 1

- Page 1-1, replace AREA - American Railway Engineering Association with ***American Railway Engineering and Maintenance of Way Association.***
- Page 1-7, remove **-L-** in middle of page after INVITATION TO BID and before LABORATORY.
- Page 1-25, 102-16(R), move 2nd paragraph to left margin. It is not a part of this subarticle, but part of the entire article.

Division 2

- Page 2-9, Subarticle 225-1(C), 1st paragraph, 2nd line, last word, add a “d” to make the word grade become **graded**
- Page 2-15, Subarticle 226-3, 5th paragraph, first line, replace the word *in* with the word ***is***.
- Page 2-23, Subarticle 235-4(B)(9), at the end of the sentence, replace finished greater with finished ***grade***.
- Page 2-28, Article 260-3, First paragraph, second line, remove the word *foot*.

Division 3

- Page 3-13, Article 340-4, Second paragraph, change Flowable Backfill to Flowable ***Fill***

Division 4

- Page 4-29, Article 420-13(A) Description, change reference from Section 1082 to ***Article 1081-6***.
- Page 4-40, Subarticle 420-17(F) first line, change Subarticle 420-17(B) to ***(B) herein***.
- Page 4-70, 442-13(B) Second sentence, change SSPC Guide 6I to SSPC Guide **6**.
- Pages 4-72, 4-74, 4-76, at the top of the page, substitute the heading Section 452 with Section ***450***.
- Page 4-79, at the top of the page, substitute the heading Section 450 with Section ***452***
- Page 4-80, change 452-7 to 452-**6** at the top of the page.
- Page 4-80, change Pay Item ___Steel Pile Retaining Walls, to ***Sheet*** Pile Retaining Walls.
- Page 4-88, 462-4, Title, Replace last word Measurement with the word ***PAYMENT***

Division 5

- Page 5-8, Article 501-15 Measurement and Payment, delete the 4th paragraph that begins The quantity of lime, measured as provided ...

- Page 5-14, Article 520-11 Measurement and Payment, first paragraph, second line, delete *will be*.

Division 6

- Page 6-3, Article 600-9, 2nd Paragraph on this page, replace 818-5 with 818-4.
- Pages 6-30 and 31, Subarticle 610-3(A)(13) Move 2 paragraphs from the margin to the right under the number (13).
- Page 6-43, Article 610-8, 4th paragraph, remove the first *the*
- Page 6-44, 2nd full paragraph, 1st sentence, delete the first *and* and add *transverse* just before cross-slope control.
- Page 6-51, at the top of the page, add **610-14** on the same line, and just before the heading MAINTENANCE.
- Page 6-53, Article 620-4 sixth paragraph, second line; the word that should be *which*.
- Page 6-66, title, Replace EXISTNG with **EXISTING**
- Page 6-66, Article 657-1, Description, first sentence, replace PS/AR (hot-poured rubber asphalt with *hot applied joint sealer*.
- Page 6-66, Article 657-2, replace PS/AR (Hot-Poured Rubber Asphalt with the following:

Item	Section
<i>Hot Applied Joint Sealer</i>	<i>1028-2</i>

- Page 6-67, at the top of the page, substitute the heading Section 654 with Section **657**.
- Page 6-67, Article 657-3 Construction Methods, 2nd paragraph, replace PS/AR sealant with *hot applied joint sealer*.
- Page 6-67, at the top of the page, substitute the heading Section 654 with Section **657**.
- Page 6-71, 660-9(B)(1), Replace the first sentence of the first paragraph with the following:

Using the quantities shown in *Table 660-1*, apply asphalt material to the existing surface followed by an application of No. 78 M or lightweight aggregate.

- Page 6-89, Add a period at the end of the last sentence at the bottom of the page.
- Page 6-90, Article 663-5, first paragraph, first sentence, change 50oF to **50°F**; third paragraph, fourth sentence change 325oF to **325°F**.

Division 7

- Page 7-12, at the top of the page, substitute the heading Section 710 with Section **700**.
- Page 7-15, Article 710-9, 4th paragraph, last line, change 710-11(B) to 710-10(B).

Division 8

- Page 8-13, Article 808-3, 4th Paragraph, third line, replace the word Eexcavation with the word **Excavation**
- Page 8-35, Article 848-2, Item: Replace Cncrete with **Concrete**

Division 9

- Page 9-2, add **901-3** just before CONSTRUCTION METHODS

Division 10

- Page 10-12, near bottom of page add (C) before Proportioning and Mixing of Modified Compositions, which should be bold type.
- Page 10-28, at the top of the page, substitute Section 1006 for 1005.
- Page 10-54, Subarticle 1018-2A), First line, substitute (B) for II, third line, substitute (B)(2) for II-b.
- Pages 10-56, 10-58, 10-60 at the top of the page, substitute Section 1018 with Section **1020**.
- Page 10-84, Table 1042-1, Class 2, Maximum, change from 23r to **23**.
- Page 10-84, Article 1042-2 Testing, last sentence, replace the word alterations with the word **cycles**.
- Page 10-100, Table 1056-1, replace on the line for Trapezoidal Tear Strength:

Type 1	Type 2	Type 3		Type 4
		Class A	Class B	Soil Stabilization
45 lb	75 lb	--	--	75 lb

- Page 10-116, Subarticle 1070-10, first paragraph, second sentence, add **or** just before cold-forged sleeve.
- Pages 10-136 through 10-147, at the top of the page, substitute Section 1074 with Section **1072**.
- Page 10-157, Article 1077-11, first paragraph, change the reference from Subarticle 420-18(B) to Subarticle 420-**17**(B).
- Page 10-200, Subarticle 1080-14(B), change reference to ASTM D3359
- Page 10-211, at the top of the page, substitute Section 1081 with Section **1082**.
- Page 10-229, add **1088-6 BLANK** on the line above 1088-7 TUBULAR MARKERS.
- Page 10-244, add **1089-10 BLANK** and **1089-11 BLANK** on the lines just above 1089-12 FLAGGER.
- Page 10-272, delete Article 1098-6 in its entirety. Renumber Articles 1098-7 through 1098-17 as Articles 1098-6 through 1098-16 consecutively.

Division 12

- Page 12-21 Add **1266-2** just before the heading MATERIALS.

Division 14

- Page 14-33, Article 1413-6, first paragraph, first sentence, first line, replace the word made with the words *paid for*.

Division 15

- Page 15-2 add **1500-4** just before the heading WEEKEND, NIGHT AND HOLIDAY WORK.
- Page 15-4, Subarticle 1505-3(A)(2), replace the 2nd line with the following: *Provide shielding or shoring as required under Section 150 or as required elsewhere in the contract.*
- Page 15-5, add **1505-6** on the same line and just before the heading MEASUREMENT AND PAYMENT. (Remove the period after PAYMENT.)
- Page 15-6, Article 1505-6(3), delete *in Section 1175* and replace it with *elsewhere in the contract*.
- Page 15-8, add **1510-4** on the same line and just before the heading MEASUREMENT AND PAYMENT.
- Page 15-10, substitute **BLANK** for CONSTRUCTION REQUIREMENTS on the same line and just before 1515-4.
- Page 15-10, substitute **CONSTRUCTION REQUIREMENTS** for General Requirements
- Page 15-10, Article 1515-4, add (**D**) just before the bolded Fire Hydrants.
- Page 15-13, Article 1520-3, 8th paragraph, add *pipe* after diameter.
- Page 15-22, add **1540-3** on the same line and just before the heading CONSTRUCTION REQUIREMENTS
- Page 15-28, Replace 1550-6 METHOD OF MEASUREMENT with **MEASUREMENT AND PAYMENT**.

Division 16

- Page 16-12, Subarticle 1632-1(C) ¼ Inch hardware cloth, change the minimum width from 24 inches to **48** inches.

Division 17

- Page 17-19, Subarticle 1725-2 Material, Second paragraph, change Article 1098-7 to 1098-8
- Page 17-20, Subarticle 1726-2 Material, Second paragraph, change Article 1098-8 to 1098-9

END

***** STANDARD SPECIAL PROVISIONS *****

AWARD OF CONTRACT

(6-28-77)

Z-6

“The North Carolina Department of Transportation, in accordance with the provisions of *Title VI of the Civil Rights Act of 1964* (78 Stat. 252) and the Regulations of the Department of Transportation (*49 C.F.R., Part 21*), issued pursuant to such act, hereby notifies all bidders that it will affirmatively insure that the contract entered into pursuant to this advertisement will be awarded to the lowest responsible bidder without discrimination on the ground of race, color, or national origin”.

***** STANDARD SPECIAL PROVISIONS *****

MINORITY AND FEMALE EMPLOYMENT REQUIREMENTS

(12-18-07)

Z-7

NOTICE OF REQUIREMENTS FOR AFFIRMATIVE ACTION TO ENSURE EQUAL EMPLOYMENT OPPORTUNITY (*EXECUTIVE NUMBER 11246*)

1. The goals and timetables for minority and female participation, expressed in percentage terms for the Contractor's aggregate workforce in each trade on all construction work in the covered area, see as shown on the attached sheet entitled "Employment Goals for Minority and Female Participation".

These goals are applicable to all the Contractor's construction work (whether or not it is Federal or federally assisted) performed in the covered area. If the Contractor performs construction work in a geographical area located outside of the covered area, it shall apply the goals established for such geographical area where the work is actually performed. With regard to this second area, the Contractor also is subject to the goals for both its federally involved and nonfederally involved construction.

The Contractor's compliance with the Executive Order and the regulations in *41 CFR Part 60-4* shall be based on its implementation of the Equal Opportunity Clause, specific affirmative action obligations required by the specifications set forth in *41 CFR 60-4.3(a)*, and its effort to meet the goals. The hours of minority and female employment and training must be substantially uniform throughout the length of the contract, and in each trade and the Contractor shall make a good faith effort to employ minorities and women evenly on each of its projects. The transfer of minority or female employees or trainees from Contractor to Contractor or from project to project or the sole purpose of meeting the Contractor's goals shall be a violation of the contract, the executive Order and the regulations in *41 CFR Part 60-4*. Compliance with the goals will be measured against the total work hours performed.

2. As used in this Notice and in the contract resulting from this solicitation, the "covered area" is the county or counties shown on the cover sheet of the proposal form and contract.

**EMPLOYMENT GOALS FOR MINORITY
AND FEMALE PARTICIPATION**

Economic Areas

Area 023 29.7%

Bertie County
Camden County
Chowan County
Gates County
Hertford County
Pasquotank County
Perquimans County

Area 024 31.7%

Beaufort County
Carteret County
Craven County
Dare County
Edgecombe County
Green County
Halifax County
Hyde County
Jones County
Lenoir County
Martin County
Nash County
Northampton County
Pamlico County
Pitt County
Tyrrell County
Washington County
Wayne County
Wilson County

Area 025 23.5%

Columbus County
Duplin County
Onslow County
Pender County

Area 026 33.5%

Bladen County
Hoke County
Richmond County
Robeson County
Sampson County
Scotland County

Area 027 24.7%

Chatham County
Franklin County
Granville County
Harnett County
Johnston County
Lee County
Person County
Vance County
Warren County

Area 028 15.5%

Alleghany County
Ashe County
Caswell County
Davie County
Montgomery County
Moore County
Rockingham County
Surry County
Watauga County
Wilkes County

Area 029 15.7%

Alexander County
Anson County
Burke County
Cabarrus County
Caldwell County
Catawba County
Cleveland County
Iredell County
Lincoln County
Polk County
Rowan County
Rutherford County
Stanly County

Area 0480 8.5%

Buncombe County
Madison County

Area 030 6.3%

Avery County
Cherokee County
Clay County
Graham County
Haywood County
Henderson County
Jackson County
McDowell County
Macon County
Mitchell County
Swain County
Transylvania County
Yancey County

SMSA Areas

Area 5720 26.6%

Currituck County

Area 9200 20.7%

Brunswick County

New Hanover County

Area 2560 24.2%

Cumberland County

Area 6640 22.8%

Durham County

Orange County

Wake County

Area 1300 16.2%

Alamance County

Area 3120 16.4%

Davidson County

Forsyth County

Guilford County

Randolph County

Stokes County

Yadkin County

Area 1520 18.3%

Gaston County

Mecklenburg County

Union County

Goals for Female

Participation in Each Trade

(Statewide) 6.9%

***** STANDARD SPECIAL PROVISIONS *****

REQUIRED CONTRACT PROVISIONS FEDERAL-AID CONSTRUCTION CONTRACTS (FHWA-1273)

- I. General
- II. Nondiscrimination
- III. Nonsegregated Facilities
- IV. Payment of Predetermined Minimum Wage
- V. Statements and Payrolls
- VI. Record of Materials, Supplies, and Labor
- VII. Subletting or Assigning the Contract
- VIII. Safety: Accident Prevention
- IX. False Statements Concerning Highway Projects
- X. Implementation of Clean Air Act and Federal Water Pollution Control Act
- XI. Certification Regarding Debarment, Suspension Ineligibility, and Voluntary Exclusion
- XII. Certification Regarding Use of Contract Funds for Lobbying

I. GENERAL

- 1. These contract provisions shall apply to all work performed on the contract by the contractor's own organization and with the assistance of workers under the contractor's immediate superintendence and to all work performed on the contract by piecework, station work, or by subcontract.
- 2. Except as otherwise provided for in each section, the contractor shall insert in each subcontract all of the stipulations contained in these Required Contract Provisions, and further require their inclusion in any lower tier subcontract or purchase order that may in turn be made. The Required Contract Provisions shall not be incorporated by reference in any case. The prime contractor shall be responsible for compliance by any subcontractor or lower tier subcontractor with these Required Contract Provisions.
- 3. A breach of any of the stipulations contained in these Required Contract Provisions shall be sufficient grounds for termination of the contract.
- 4. A breach of the following clauses of the Required Contract Provisions may also be grounds for debarment as provided in 29 CFR 5.12:
 - Section I, paragraph 2;
 - Section IV, paragraphs 1, 2, 3, 4, and 7;
 - Section V, paragraphs 1 and 2a through 2g.
- 5. Disputes arising out of the labor standards provisions of Section IV (except paragraph 5) and Section V of these Required Contract Provisions shall not be subject to the general disputes clause of this contract. Such disputes shall be resolved in accordance with the procedures of the U.S. Department of Labor (DOL) as set forth in 29 CFR 5, 6, and 7. Disputes within the meaning of this clause include disputes between the contractor (or any of its subcontractors) and the contracting agency, the DOL, or the contractor's employees or their representatives.
- 6. **Selection of Labor:** During the performance of this contract, the contractor shall not:
 - a. discriminate against labor from any other State, possession, or territory of the United States (except for employment preference for Appalachian contracts, when applicable, as specified in Attachment A), or
 - b. employ convict labor for any purpose within the limits of the project unless it is labor performed by convicts who are on parole, supervised release, or probation.

II. NONDISCRIMINATION

(Applicable to all Federal-aid construction contracts and to all related subcontracts of \$10,000 or more.)

- 1. **Equal Employment Opportunity:** Equal employment opportunity (EEO) requirements not to discriminate and to take affirmative action to assure equal opportunity as set forth under laws, executive orders, rules, regulations (28 CFR 35, 29 CFR 1630 and 41 CFR 60) and orders of the Secretary of Labor as modified by the provisions prescribed herein, and imposed pursuant to 23 U.S.C. 140 shall constitute the EEO and specific affirmative action standards for the contractor's project activities under this contract. The Equal Opportunity Construction Contract Specifications set forth under 41 CFR 60-4.3 and the provisions of the American Disabilities Act of 1990 (42 U.S.C. 12101 *et seq.*) set forth under 28 CFR 35 and 29 CFR 1630 are incorporated by reference in this contract. In the execution of this contract, the contractor agrees to comply with the following minimum specific requirement activities of EEO:
 - a. The contractor will work with the State highway agency (SHA) and the Federal Government in carrying out EEO obligations and in their review of his/her activities under the contract.

- b. The contractor will accept as his operating policy the following statement:
- "It is the policy of this Company to assure that applicants are employed, and that employees are treated during employment, without regard to their race, religion, sex, color, national origin, age or disability. Such action shall include: employment, upgrading, demotion, or transfer; recruitment or recruitment advertising; layoff or termination; rates of pay or other forms of compensation; and selection for training, including apprenticeship, preapprenticeship, and/or on-the-job training."
2. **EEO Officer:** The contractor will designate and make known to the SHA contracting officers an EEO Officer who will have the responsibility for and must be capable of effectively administering and promoting an active contractor program of EEO and who must be assigned adequate authority and responsibility to do so.
 3. **Dissemination of Policy:** All members of the contractor's staff who are authorized to hire, supervise, promote, and discharge employees, or who recommend such action, or who are substantially involved in such action, will be made fully cognizant of, and will implement, the contractor's EEO policy and contractual responsibilities to provide EEO in each grade and classification of employment. To ensure that the above agreement will be met, the following actions will be taken as a minimum:
 - a. Periodic meetings of supervisory and personnel office employees will be conducted before the start of work and then not less often than once every six months, at which time the contractor's EEO policy and its implementation will be reviewed and explained. The meetings will be conducted by the EEO Officer.
 - b. All new supervisory or personnel office employees will be given a thorough indoctrination by the EEO Officer, covering all major aspects of the contractor's EEO obligations within thirty days following their reporting for duty with the contractor.
 - c. All personnel who are engaged in direct recruitment for the project will be instructed by the EEO Officer in the contractor's procedures for locating and hiring minority group employees.
 - d. Notices and posters setting forth the contractor's EEO policy will be placed in areas readily accessible to employees, applicants for employment and potential employees.
 - e. The contractor's EEO policy and the procedures to implement such policy will be brought to the attention of employees by means of meetings, employee handbooks, or other appropriate means.
 4. **Recruitment:** When advertising for employees, the contractor will include in all advertisements for employees the notation: "An Equal Opportunity Employer." All such advertisements will be placed in publications having a large circulation among minority groups in the area from which the project work force would normally be derived.
 - a. The contractor will, unless precluded by a valid bargaining agreement, conduct systematic and direct recruitment through public and private employee referral sources likely to yield qualified minority group applicants. To meet this requirement, the contractor will identify sources of potential minority group employees, and establish with such identified sources procedures whereby minority group applicants may be referred to the contractor for employment consideration.
 - b. In the event the contractor has a valid bargaining agreement providing for exclusive hiring hall referrals, he is expected to observe the provisions of that agreement to the extent that the system permits the contractor's compliance with EEO contract provisions. (The DOL has held that where implementation of such agreements have the effect of discriminating against minorities or women, or obligates the contractor to do the same, such implementation violates Executive Order 11246, as amended.)
 - c. The contractor will encourage his present employees to refer minority group applicants for employment. Information and procedures with regard to referring minority group applicants will be discussed with employees.
 5. **Personnel Actions:** Wages, working conditions, and employee benefits shall be established and administered, and personnel actions of every type, including hiring, upgrading, promotion, transfer, demotion, layoff, and termination, shall be taken without regard to race, color, religion, sex, national origin, age or disability. The following procedures shall be followed:
 - a. The contractor will conduct periodic inspections of project sites to insure that working conditions and employee facilities do not indicate discriminatory treatment of project site personnel.
 - b. The contractor will periodically evaluate the spread of wages paid within each classification to determine any evidence of discriminatory wage practices.
 - c. The contractor will periodically review selected personnel actions in depth to determine whether there is evidence of discrimination. Where evidence is found, the contractor will promptly take corrective action. If the review indicates that the discrimination may extend beyond the actions reviewed, such corrective action shall include all affected persons.
 - d. The contractor will promptly investigate all complaints of alleged discrimination made to the contractor in connection with his obligations under this contract, will attempt to resolve such complaints, and will take appropriate corrective action within a reasonable time. If the investigation indicates that the discrimination may affect persons other than the complainant, such corrective action shall include such other persons. Upon completion of each investigation, the contractor will inform every complainant of all of his avenues of appeal.
 6. **Training and Promotion:**
 - a. The contractor will assist in locating, qualifying, and increasing the skills of minority group and women employees, and applicants for employment.
 - b. Consistent with the contractor's work force requirements and as permissible under Federal and State regulations, the contractor shall make full use of training programs, i.e., apprenticeship, and on-the-job training programs for the geographical area of contract performance. Where feasible, 25 percent of apprentices or trainees in each occupation shall be in their first year of apprenticeship or training. In the event a special provision for training is provided under this contract, this subparagraph will be superseded as indicated in the special provision.

- c. The contractor will advise employees and applicants for employment of available training programs and entrance requirements for each.
 - d. The contractor will periodically review the training and promotion potential of minority group and women employees and will encourage eligible employees to apply for such training and promotion.
7. **Unions:** If the contractor relies in whole or in part upon unions as a source of employees, the contractor will use his/her best efforts to obtain the cooperation of such unions to increase opportunities for minority groups and women within the unions, and to effect referrals by such unions of minority and female employees. Actions by the contractor either directly or through a contractor's association acting as agent will include the procedures set forth below:
- a. The contractor will use best efforts to develop, in cooperation with the unions, joint training programs aimed toward qualifying more minority group members and women for membership in the unions and increasing the skills of minority group employees and women so that they may qualify for higher paying employment.
 - b. The contractor will use best efforts to incorporate an EEO clause into each union agreement to the end that such union will be contractually bound to refer applicants without regard to their race, color, religion, sex, national origin, age or disability.
 - c. The contractor is to obtain information as to the referral practices and policies of the labor union except that to the extent such information is within the exclusive possession of the labor union and such labor union refuses to furnish such information to the contractor, the contractor shall so certify to the SHA and shall set forth what efforts have been made to obtain such information.
 - d. In the event the union is unable to provide the contractor with a reasonable flow of minority and women referrals within the time limit set forth in the collective bargaining agreement, the contractor will, through independent recruitment efforts, fill the employment vacancies without regard to race, color, religion, sex, national origin, age or disability; making full efforts to obtain qualified and/or qualifiable minority group persons and women. (The DOL has held that it shall be no excuse that the union with which the contractor has a collective bargaining agreement providing for exclusive referral failed to refer minority employees.) In the event the union referral practice prevents the contractor from meeting the obligations pursuant to Executive Order 11246, as amended, and these special provisions, such contractor shall immediately notify the SHA.
8. **Selection of Subcontractors, Procurement of Materials and Leasing of Equipment:** The contractor shall not discriminate on the grounds of race, color, religion, sex, national origin, age or disability in the selection and retention of subcontractors, including procurement of materials and leases of equipment.
- a. The contractor shall notify all potential subcontractors and suppliers of his/her EEO obligations under this contract.
 - b. Disadvantaged business enterprises (DBE), as defined in 49 CFR 23, shall have equal opportunity to compete for and perform subcontracts which the contractor enters into pursuant to this contract. The contractor will use his best efforts to solicit bids from and to utilize DBE subcontractors or subcontractors with meaningful minority group and female representation among their employees. Contractors shall obtain lists of DBE construction firms from SHA personnel.
 - c. The contractor will use his best efforts to ensure subcontractor compliance with their EEO obligations.
9. **Records and Reports:** The contractor shall keep such records as necessary to document compliance with the EEO requirements. Such records shall be retained for a period of three years following completion of the contract work and shall be available at reasonable times and places for inspection by authorized representatives of the SHA and the FHWA.
- a. The records kept by the contractor shall document the following:
 - 1. The number of minority and non-minority group members and women employed in each work classification on the project;
 - 2. The progress and efforts being made in cooperation with unions, when applicable, to increase employment opportunities for minorities and women;
 - 3. The progress and efforts being made in locating, hiring, training, qualifying, and upgrading minority and female employees; and
 - 4. The progress and efforts being made in securing the services of DBE subcontractors or subcontractors with meaningful minority and female representation among their employees.
 - b. The contractors will submit an annual report to the SHA each July for the duration of the project, indicating the number of minority, women, and non-minority group employees currently engaged in each work classification required by the contract work. This information is to be reported on Form FHWA-1391. If on-the-job training is being required by special provision, the contractor will be required to collect and report training data.

III. NONSEGREGATED FACILITIES

(Applicable to all Federal-aid construction contracts and to all related subcontracts of \$10,000 or more.)

- a. By submission of this bid, the execution of this contract or subcontract, or the consummation of this material supply agreement or purchase order, as appropriate, the bidder, Federal-aid construction contractor, subcontractor, material supplier, or vendor, as appropriate, certifies that the firm does not maintain or provide for its employees any segregated facilities at any of its establishments, and that the firm does not permit its employees to perform their services at any location, under its control, where segregated facilities are maintained. The firm agrees that a breach of this certification is a violation of the EEO provisions of this contract. The firm further certifies that no employee will be denied access to adequate facilities on the basis of sex or disability.
- b. As used in this certification, the term "segregated facilities" means any waiting rooms, work areas, restrooms and washrooms, restaurants and other eating areas, timeclocks, locker rooms, and other storage or dressing areas, parking lots, drinking fountains, recreation or entertainment areas, transportation, and housing facilities provided for employees which are segregated by explicit directive, or are, in fact, segregated on the basis of race, color, religion, national origin, age or disability, because of habit, local custom, or otherwise. The only exception will be for the disabled when the demands for accessibility override (e.g. disabled parking).

- c. The contractor agrees that it has obtained or will obtain identical certification from proposed subcontractors or material suppliers prior to award of subcontracts or consummation of material supply agreements of \$10,000 or more and that it will retain such certifications in its files.

IV. PAYMENT OF PREDETERMINED MINIMUM WAGE

(Applicable to all Federal-aid construction contracts exceeding \$2,000 and to all related subcontracts, except for projects located on roadways classified as local roads or rural minor collectors, which are exempt.)

1. General:

- a. All mechanics and laborers employed or working upon the site of the work will be paid unconditionally and not less often than once a week and without subsequent deduction or rebate on any account [except such payroll deductions as are permitted by regulations (29 CFR 3) issued by the Secretary of Labor under the Copeland Act (40 U.S.C. 276c)] the full amounts of wages and bona fide fringe benefits (or cash equivalents thereof) due at time of payment. The payment shall be computed at wage rates not less than those contained in the wage determination of the Secretary of Labor (hereinafter "the wage determination") which is attached hereto and made a part hereof, regardless of any contractual relationship which may be alleged to exist between the contractor or its subcontractors and such laborers and mechanics. The wage determination (including any additional classifications and wage rates conformed under paragraph 2 of this Section IV and the DOL poster (WH-1321) or Form FHWA-1495) shall be posted at all times by the contractor and its subcontractors at the site of the work in a prominent and accessible place where it can be easily seen by the workers. For the purpose of this Section, contributions made or costs reasonably anticipated for bona fide fringe benefits under Section 1(b)(2) of the Davis-Bacon Act (40 U.S.C. 276a) on behalf of laborers or mechanics are considered wages paid to such laborers or mechanics, subject to the provisions of Section IV, paragraph 3b, hereof. Also, for the purpose of this Section, regular contributions made or costs incurred for more than a weekly period (but not less often than quarterly) under plans, funds, or programs, which cover the particular weekly period, are deemed to be constructively made or incurred during such weekly period. Such laborers and mechanics shall be paid the appropriate wage rate and fringe benefits on the wage determination for the classification of work actually performed, without regard to skill, except as provided in paragraphs 4 and 5 of this Section IV.
- b. Laborers or mechanics performing work in more than one classification may be compensated at the rate specified for each classification for the time actually worked therein, provided, that the employer's payroll records accurately set forth the time spent in each classification in which work is performed.
- c. All rulings and interpretations of the Davis-Bacon Act and related acts contained in 29 CFR 1, 3, and 5 are herein incorporated by reference in this contract.

2. Classification:

- a. The SHA contracting officer shall require that any class of laborers or mechanics employed under the contract, which is not listed in the wage determination, shall be classified in conformance with the wage determination.
- b. The contracting officer shall approve an additional classification, wage rate and fringe benefits only when the following criteria have been met:
 - 1. the work to be performed by the additional classification requested is not performed by a classification in the wage determination;
 - 2. the additional classification is utilized in the area by the construction industry;
 - 3. the proposed wage rate, including any bona fide fringe benefits, bears a reasonable relationship to the wage rates contained in the wage determination; and
 - 4. with respect to helpers, when such a classification prevails in the area in which the work is performed.
- c. If the contractor or subcontractors, as appropriate, the laborers and mechanics (if known) to be employed in the additional classification or their representatives, and the contracting officer agree on the classification and wage rate (including the amount designated for fringe benefits where appropriate), a report of the action taken shall be sent by the contracting officer to the DOL, Administrator of the Wage and Hour Division, Employment Standards Administration, Washington, D.C. 20210. The Wage and Hour Administrator, or an authorized representative, will approve, modify, or disapprove every additional classification action within 30 days of receipt and so advise the contracting officer or will notify the contracting officer within the 30-day period that additional time is necessary.
- d. In the event the contractor or subcontractors, as appropriate, the laborers or mechanics to be employed in the additional classification or their representatives, and the contracting officer do not agree on the proposed classification and wage rate (including the amount designated for fringe benefits, where appropriate), the contracting officer shall refer the questions, including the views of all interested parties and the recommendation of the contracting officer, to the Wage and Hour Administrator for determination. Said Administrator, or an authorized representative, will issue a determination within 30 days of receipt and so advise the contracting officer or will notify the contracting officer within the 30-day period that additional time is necessary.
- e. The wage rate (including fringe benefits where appropriate) determined pursuant to paragraph 2c or 2d of this Section IV shall be paid to all workers performing work in the additional classification from the first day on which work is performed in the classification.

3. Payment of Fringe Benefits:

- a. Whenever the minimum wage rate prescribed in the contract for a class of laborers or mechanics includes a fringe benefit which is not expressed as an hourly rate, the contractor or subcontractors, as appropriate, shall either pay the benefit as stated in the wage determination or shall pay another bona fide fringe benefit or an hourly case equivalent thereof.

- b. If the contractor or subcontractor, as appropriate, does not make payments to a trustee or other third person, he/she may consider as a part of the wages of any laborer or mechanic the amount of any costs reasonably anticipated in providing bona fide fringe benefits under a plan or program, provided, that the Secretary of Labor has found, upon the written request of the contractor, that the applicable standards of the Davis-Bacon Act have been met. The Secretary of Labor may require the contractor to set aside in a separate account assets for the meeting of obligations under the plan or program.

4. Apprentices and Trainees (Programs of the U.S. DOL) and Helpers:

a. Apprentices:

1. Apprentices will be permitted to work at less than the predetermined rate for the work they performed when they are employed pursuant to and individually registered in a bona fide apprenticeship program registered with the DOL, Employment and Training Administration, Bureau of Apprenticeship and Training, or with a State apprenticeship agency recognized by the Bureau, or if a person is employed in his/her first 90 days of probationary employment as an apprentice in such an apprenticeship program, who is not individually registered in the program, but who has been certified by the Bureau of Apprenticeship and Training or a State apprenticeship agency (where appropriate) to be eligible for probationary employment as an apprentice.
2. The allowable ratio of apprentices to journeyman-level employees on the job site in any craft classification shall not be greater than the ratio permitted to the contractor as to the entire work force under the registered program. Any employee listed on a payroll at an apprentice wage rate, who is not registered or otherwise employed as stated above, shall be paid not less than the applicable wage rate listed in the wage determination for the classification of work actually performed. In addition, any apprentice performing work on the job site in excess of the ratio permitted under the registered program shall be paid not less than the applicable wage rate on the wage determination for the work actually performed. Where a contractor or subcontractor is performing construction on a project in a locality other than that in which its program is registered, the ratios and wage rates (expressed in percentages of the journeyman-level hourly rate) specified in the contractor's or subcontractor's registered program shall be observed.
3. Every apprentice must be paid at not less than the rate specified in the registered program for the apprentice's level of progress, expressed as a percentage of the journeyman-level hourly rate specified in the applicable wage determination. Apprentices shall be paid fringe benefits in accordance with the provisions of the apprenticeship program. If the apprenticeship program does not specify fringe benefits, apprentices must be paid the full amount of fringe benefits listed on the wage determination for the applicable classification. If the Administrator for the Wage and Hour Division determines that a different practice prevails for the applicable apprentice classification, fringes shall be paid in accordance with that determination.
4. In the event the Bureau of Apprenticeship and Training, or a State apprenticeship agency recognized by the Bureau, withdraws approval of an apprenticeship program, the contractor or subcontractor will no longer be permitted to utilize apprentices at less than the applicable predetermined rate for the comparable work performed by regular employees until an acceptable program is approved.

b. Trainees:

1. Except as provided in 29 CFR 5.16, trainees will not be permitted to work at less than the predetermined rate for the work performed unless they are employed pursuant to and individually registered in a program which has received prior approval, evidenced by formal certification by the DOL, Employment and Training Administration.
2. The ratio of trainees to journeyman-level employees on the job site shall not be greater than permitted under the plan approved by the Employment and Training Administration. Any employee listed on the payroll at a trainee rate who is not registered and participating in a training plan approved by the Employment and Training Administration shall be paid not less than the applicable wage rate on the wage determination for the classification of work actually performed. In addition, any trainee performing work on the job site in excess of the ratio permitted under the registered program shall be paid not less than the applicable wage rate on the wage determination for the work actually performed.
3. Every trainee must be paid at not less than the rate specified in the approved program for his/her level of progress, expressed as a percentage of the journeyman-level hourly rate specified in the applicable wage determination. Trainees shall be paid fringe benefits in accordance with the provisions of the trainee program. If the trainee program does not mention fringe benefits, trainees shall be paid the full amount of fringe benefits listed on the wage determination unless the Administrator of the Wage and Hour Division determines that there is an apprenticeship program associated with the corresponding journeyman-level wage rate on the wage determination which provides for less than full fringe benefits for apprentices, in which case such trainees shall receive the same fringe benefits as apprentices.
4. In the event the Employment and Training Administration withdraws approval of a training program, the contractor or subcontractor will no longer be permitted to utilize trainees at less than the applicable predetermined rate for the work performed until an acceptable program is approved.

c. Helpers:

Helpers will be permitted to work on a project if the helper classification is specified and defined on the applicable wage determination or is approved pursuant to the conformance procedure set forth in Section IV.2. Any worker listed on a payroll at a helper wage rate, who is not a helper under an approved definition, shall be paid not less than the applicable wage rate on the wage determination for the classification of work actually performed.

5. Apprentices and Trainees (Programs of the U.S. DOT):

Apprentices and trainees working under apprenticeship and skill training programs which have been certified by the Secretary of Transportation as promoting EEO in connection with Federal-aid highway construction programs are not subject to the requirements

of paragraph 4 of this Section IV. The straight time hourly wage rates for apprentices and trainees under such programs will be established by the particular programs. The ratio of apprentices and trainees to journeymen shall not be greater than permitted by the terms of the particular program.

6. **Withholding:**

The SHA shall upon its own action or upon written request of an authorized representative of the DOL withhold, or cause to be withheld, from the contractor or subcontractor under this contract or any other Federal contract with the same prime contractor, or any other Federally-assisted contract subject to Davis-Bacon prevailing wage requirements which is held by the same prime contractor, as much of the accrued payments or advances as may be considered necessary to pay laborers and mechanics, including apprentices, trainees, and helpers, employed by the contractor or any subcontractor the full amount of wages required by the contract. In the event of failure to pay any laborer or mechanic, including any apprentice, trainee, or helper, employed or working on the site of the work, all or part of the wages required by the contract, the SHA contracting officer may, after written notice to the contractor, take such action as may be necessary to cause the suspension of any further payment, advance, or guarantee of funds until such violations have ceased.

7. **Overtime Requirements:**

No contractor or subcontractor contracting for any part of the contract work which may require or involve the employment of laborers, mechanics, watchmen, or guards (including apprentices, trainees, and helpers described in paragraphs 4 and 5 above) shall require or permit any laborer, mechanic, watchman, or guard in any workweek in which he/she is employed on such work, to work in excess of 40 hours in such workweek unless such laborer, mechanic, watchman, or guard receives compensation at a rate not less than one-and-one-half times his/her basic rate of pay for all hours worked in excess of 40 hours in such workweek.

8. **Violation:**

Liability for Unpaid Wages; Liquidated Damages: In the event of any violation of the clause set forth in paragraph 7 above, the contractor and any subcontractor responsible thereof shall be liable to the affected employee for his/her unpaid wages. In addition, such contractor and subcontractor shall be liable to the United States (in the case of work done under contract for the District of Columbia or a territory, to such District or to such territory) for liquidated damages. Such liquidated damages shall be computed with respect to each individual laborer, mechanic, watchman, or guard employed in violation of the clause set forth in paragraph 7, in the sum of \$10 for each calendar day on which such employee was required or permitted to work in excess of the standard work week of 40 hours without payment of the overtime wages required by the clause set forth in paragraph 7.

9. **Withholding for Unpaid Wages and Liquidated Damages:**

The SHA shall upon its own action or upon written request of any authorized representative of the DOL withhold, or cause to be withheld, from any monies payable on account of work performed by the contractor or subcontractor under any such contract or any other Federal contract with the same prime contractor, or any other Federally-assisted contract subject to the Contract Work Hours and Safety Standards Act, which is held by the same prime contractor, such sums as may be determined to be necessary to satisfy any liabilities of such contractor or subcontractor for unpaid wages and liquidated damages as provided in the clause set forth in paragraph 8 above.

V. **STATEMENTS AND PAYROLLS**

(Applicable to all Federal-aid construction contracts exceeding \$2,000 and to all related subcontracts, except for projects located on roadways classified as local roads or rural collectors, which are exempt.)

1. **Compliance with Copeland Regulations (29 CFR 3):**

The contractor shall comply with the Copeland Regulations of the Secretary of Labor which are herein incorporated by reference.

2. **Payrolls and Payroll Records:**

- a. Payrolls and basic records relating thereto shall be maintained by the contractor and each subcontractor during the course of the work and preserved for a period of 3 years from the date of completion of the contract for all laborers, mechanics, apprentices, trainees, watchmen, helpers, and guards working at the site of the work.
- b. The payroll records shall contain the name, social security number, and address of each such employee; his or her correct classification; hourly rates of wages paid (including rates of contributions or costs anticipated for bona fide fringe benefits or cash equivalent thereof of the types described in Section 1(b)(2)(B) of the Davis Bacon Act); daily and weekly number of hours worked; deductions made; and actual wages paid. In addition, for Appalachian contracts, the payroll records shall contain a notation indicating whether the employee does, or does not, normally reside in the labor area as defined in Attachment A, paragraph 1. Whenever the Secretary of Labor, pursuant to Section IV, paragraph 3b, has found that the wages of any laborer or mechanic include the amount of any costs reasonably anticipated in providing benefits under a plan or program described in Section 1(b)(2)(B) of the Davis Bacon Act, the contractor and each subcontractor shall maintain records which show that the commitment to provide such benefits is enforceable, that the plan or program is financially responsible, that the plan or program has been communicated in writing to the laborers or mechanics affected, and show the cost anticipated or the actual cost incurred in providing benefits. Contractors or subcontractors employing apprentices or trainees under approved programs shall maintain written evidence of the registration of apprentices and trainees, and ratios and wage rates prescribed in the applicable programs.
- c. Each contractor and subcontractor shall furnish, each week in which any contract work is performed, to the SHA resident engineer a payroll of wages paid each of its employees (including apprentices, trainees, and helpers, described in Section IV, paragraphs 4 and 5, and watchmen and guards engaged on work during the preceding weekly payroll period). The payroll submitted shall set out accurately and completely all of the information required to be maintained under paragraph 2b of this Section V. This information may be submitted in any form desired. Optional Form WH-347 is available for this purpose and may be purchased from the Superintendent of Documents (Federal stock number 029-005-0014-1), U.S. Government Printing

Office, Washington, D.C. 20402. The prime contractor is responsible for the submission of copies of payrolls by all subcontractors.

- d. Each payroll submitted shall be accompanied by a "Statement of Compliance," signed by the contractor or subcontractor or his/her agent who pays or supervises the payment of the persons employed under the contract and shall certify the following:
 1. that the payroll for the payroll period contains the information required to be maintained under paragraph 2b of this Section V and that such information is correct and complete;
 2. that such laborer or mechanic (including each helper, apprentice, and trainee) employed on the contract during the payroll period has been paid the full weekly wages earned, without rebate, either directly or indirectly, and that no deductions have been made either directly or indirectly from the full wages earned, other than permissible deductions as set forth in the Regulations, 29 CFR 3;
 3. that each laborer or mechanic has been paid not less than the applicable wage rate and fringe benefits or cash equivalent for the classification of work performed, as specified in the applicable wage determination incorporated into the contract.
- e. The weekly submission of a properly executed certification set forth on the reverse side of Optional Form WH-347 shall satisfy the requirement for submission of the "Statement of Compliance" required by paragraph 2d of this Section V.
- f. The falsification of any of the above certifications may subject the contractor to civil or criminal prosecution under 18 U.S.C. 1001 and 31 U.S.C. 231.
- g. The contractor or subcontractor shall make the records required under paragraph 2b of this Section V available for inspection, copying, or transcription by authorized representatives of the SHA, the FHWA, or the DOL, and shall permit such representatives to interview employees during working hours on the job. If the contractor or subcontractor fails to submit the required records or to make them available, the SHA, the FHWA, the DOL, or all may, after written notice to the contractor, sponsor, applicant, or owner, take such actions as may be necessary to cause the suspension of any further payment, advance, or guarantee of funds. Furthermore, failure to submit the required records upon request or to make such records available may be grounds for debarment action pursuant to 29 CFR 5.12.

VI. RECORD OF MATERIALS, SUPPLIES, AND LABOR THIS SECTION DELETED JUNE 4, 2007.

VII. SUBLETTING OR ASSIGNING THE CONTRACT

1. The contractor shall perform with its own organization contract work amounting to not less than 30 percent (or a greater percentage if specified elsewhere in the contract) of the total original contract price, excluding any specialty items designated by the State. Specialty items may be performed by subcontract and the amount of any such specialty items performed may be deducted from the total original contract price before computing the amount of work required to be performed by the contractor's own organization (23 CFR 635).
 - a. "Its own organization" shall be construed to include only workers employed and paid directly by the prime contractor and equipment owned or rented by the prime contractor, with or without operators. Such term does not include employees or equipment of a subcontractor, assignee, or agent of the prime contractor.
 - b. "Specialty Items" shall be construed to be limited to work that requires highly specialized knowledge, abilities, or equipment not ordinarily available in the type of contracting organizations qualified and expected to bid on the contract as a whole and in general are to be limited to minor components of the overall contract.
2. The contract amount upon which the requirements set forth in paragraph 1 of Section VII is computed includes the cost of material and manufactured products which are to be purchased or produced by the contractor under the contract provisions.
3. The contractor shall furnish (a) a competent superintendent or supervisor who is employed by the firm, has full authority to direct performance of the work in accordance with the contract requirements, and is in charge of all construction operations (regardless of who performs the work) and (b) such other of its own organizational resources (supervision, management, and engineering services) as the SHA contracting officer determines is necessary to assure the performance of the contract.
4. No portion of the contract shall be sublet, assigned or otherwise disposed of except with the written consent of the SHA contracting officer, or authorized representative, and such consent when given shall not be construed to relieve the contractor of any responsibility for the fulfillment of the contract. Written consent will be given only after the SHA has assured that each subcontract is evidenced in writing and that it contains all pertinent provisions and requirements of the prime contract.

VIII. SAFETY: ACCIDENT PREVENTION

1. In the performance of this contract the contractor shall comply with all applicable Federal, State, and local laws governing safety, health, and sanitation (23 CFR 635). The contractor shall provide all safeguards, safety devices and protective equipment and take any other needed actions as it determines, or as the SHA contracting officer may determine, to be reasonably necessary to protect the life and health of employees on the job and the safety of the public and to protect property in connection with the performance of the work covered by the contract.
2. It is a condition of this contract, and shall be made a condition of each subcontract, which the contractor enters into pursuant to this contract, that the contractor and any subcontractor shall not permit any employee, in performance of the contract, to work in surroundings or under conditions which are unsanitary, hazardous or dangerous to his/her health or safety, as determined under construction safety and health standards (29 CFR 1926) promulgated by the Secretary of Labor, in accordance with Section 107 of the Contract Work Hours and Safety Standards Act (40 U.S.C. 333).
3. Pursuant to 29 CFR 1926.3, it is a condition of this contract that the Secretary of Labor or authorized representative thereof, shall have right of entry to any site of contract performance to inspect or investigate the matter of compliance with the construction safety

and health standards and to carry out the duties of the Secretary under Section 107 of the Contract Work Hours and Safety Standards Act (40 U.S.C. 333).

IX. FALSE STATEMENTS CONCERNING HIGHWAY PROJECTS

In order to assure high quality and durable construction in conformity with approved plans and specifications and a high degree of reliability on statements and representations made by engineers, contractors, suppliers, and workers on Federal-aid highway projects, it is essential that all persons concerned with the project perform their functions as carefully, thoroughly, and honestly as possible. Willful falsification, distortion, or misrepresentation with respect to any facts related to the project is a violation of Federal law. To prevent any misunderstanding regarding the seriousness of these and similar acts, the following notice shall be posted on each Federal-aid highway project (23 CFR 635) in one or more places where it is readily available to all persons concerned with the project:

NOTICE TO ALL PERSONNEL ENGAGED ON FEDERAL-AID HIGHWAY PROJECTS

18 U.S.C. 1020 reads as follows:

"Whoever, being an officer, agent, or employee of the United States, or of any State or Territory, or whoever, whether a person, association, firm, or corporation, knowingly makes any false statement, false representation, or false report as to the character, quality, quantity, or cost of the material used or to be used, or the quantity or quality of the work performed or to be performed, or the cost thereof in connection with the submission of plans, maps, specifications, contracts, or costs of construction on any highway or related project submitted for approval to the Secretary of Transportation; or

Whoever knowingly makes any false statement, false representation, false report or false claim with respect to the character, quality, quantity, or cost of any work performed or to be performed, or materials furnished or to be furnished, in connection with the construction of any highway or related project approved by the Secretary of Transportation; or

Whoever knowingly makes any false statement or false representation as to material fact in any statement, certificate, or report submitted pursuant to provisions of the Federal-aid Roads Act approved July 1, 1916, (39 Stat. 355), as amended and supplemented;

Shall be fined not more than \$10,000 or imprisoned not more than 5 years or both."

X. IMPLEMENTATION OF CLEAN AIR ACT AND FEDERAL WATER POLLUTION CONTROL ACT

(Applicable to all Federal-aid construction contracts and to all related subcontracts of \$100,000 or more.)

By submission of this bid or the execution of this contract, or subcontract, as appropriate, the bidder, Federal-aid construction contractor, or subcontractor, as appropriate, will be deemed to have stipulated as follows:

1. That any facility that is or will be utilized in the performance of this contract, unless such contract is exempt under the Clean Air Act, as amended (42 U.S.C. 1857 *et seq.*, as amended by Pub.L. 91-604), and under the Federal Water Pollution Control Act, as amended (33 U.S.C. 1251 *et seq.*, as amended by Pub.L. 92-500), Executive Order 11738, and regulations in implementation thereof (40 CFR 15) is not listed, on the date of contract award, on the U.S. Environmental Protection Agency (EPA) List of Violating Facilities pursuant to 40 CFR 15.20.
2. That the firm agrees to comply and remain in compliance with all the requirements of Section 114 of the Clean Air Act and Section 308 of the Federal Water Pollution Control Act and all regulations and guidelines listed thereunder.
3. That the firm shall promptly notify the SHA of the receipt of any communication from the Director, Office of Federal Activities, EPA, indicating that a facility that is or will be utilized for the contract is under consideration to be listed on the EPA List of Violating Facilities.
4. That the firm agrees to include or cause to be included the requirements of paragraph 1 through 4 of this Section X in every nonexempt subcontract, and further agrees to take such action as the government may direct as a means of enforcing such requirements.

XI. CERTIFICATION REGARDING DEBARMENT, SUSPENSION, INELIGIBILITY AND VOLUNTARY EXCLUSION

1. Instructions for Certification - Primary Covered Transactions:

(Applicable to all Federal-aid contracts - 49 CFR 29)

- a. By signing and submitting this proposal, the prospective primary participant is providing the certification set out below.
- b. The inability of a person to provide the certification set out below will not necessarily result in denial of participation in this covered transaction. The prospective participant shall submit an explanation of why it cannot provide the certification set out below. The certification or explanation will be considered in connection with the department or agency's determination whether to enter into this transaction. However, failure of the prospective primary participant to furnish a certification or an explanation shall disqualify such a person from participation in this transaction.
- c. The certification in this clause is a material representation of fact upon which reliance was placed when the department or agency determined to enter into this transaction. If it is later determined that the prospective primary participant knowingly rendered an erroneous certification, in addition to other remedies available to the Federal Government, the department or agency may terminate this transaction for cause of default.
- d. The prospective primary participant shall provide immediate written notice to the department or agency to whom this proposal is submitted if any time the prospective primary participant learns that its certification was erroneous when submitted or has become erroneous by reason of changed circumstances.
- e. The terms "covered transaction," "debarred," "suspended," "ineligible," "lower tier covered transaction," "participant," "person," "primary covered transaction," "principal," "proposal," and "voluntarily excluded," as used in this clause, have the meanings set out in the Definitions and Coverage sections of rules implementing Executive Order 12549. You may contact the department or agency to which this proposal is submitted for assistance in obtaining a copy of those regulations.

- f. The prospective primary participant agrees by submitting this proposal that, should the proposed covered transaction be entered into, it shall not knowingly enter into any lower tier covered transaction with a person who is debarred, suspended, declared ineligible, or voluntarily excluded from participation in this covered transaction, unless authorized by the department or agency entering into this transaction.
- g. The prospective primary participant further agrees by submitting this proposal that it will include the clause titled "Certification Regarding Debarment, Suspension, Ineligibility and Voluntary Exclusion-Lower Tier Covered Transaction," provided by the department or agency entering into this covered transaction, without modification, in all lower tier covered transactions and in all solicitations for lower tier covered transactions.
- h. A participant in a covered transaction may rely upon a certification of a prospective participant in a lower tier covered transaction that is not debarred, suspended, ineligible, or voluntarily excluded from the covered transaction, unless it knows that the certification is erroneous. A participant may decide the method and frequency by which it determines the eligibility of its principals. Each participant may, but is not required to, check the nonprocurement portion of the "Lists of Parties Excluded From Federal Procurement or Nonprocurement Programs" (Nonprocurement List) which is compiled by the General Services Administration.
- i. Nothing contained in the foregoing shall be construed to require establishment of a system of records in order to render in good faith the certification required by this clause. The knowledge and information of participant is not required to exceed that which is normally possessed by a prudent person in the ordinary course of business dealings.
- j. Except for transactions authorized under paragraph f of these instructions, if a participant in a covered transaction knowingly enters into a lower tier covered transaction with a person who is suspended, debarred, ineligible, or voluntarily excluded from participation in this transaction, in addition to other remedies available to the Federal Government, the department or agency may terminate this transaction for cause or default.

Certification Regarding Debarment, Suspension, Ineligibility and Voluntary Exclusion--Primary Covered Transactions

- 1. The prospective primary participant certifies to the best of its knowledge and belief, that it and its principals:
 - a. Are not presently debarred, suspended, proposed for debarment, declared ineligible, or voluntarily excluded from covered transactions by any Federal department or agency;
 - b. Have not within a 3-year period preceding this proposal been convicted of or had a civil judgement rendered against them for commission of fraud or a criminal offense in connection with obtaining, attempting to obtain, or performing a public (Federal, State or local) transaction or contract under a public transaction; violation of Federal or State antitrust statutes or commission of embezzlement, theft, forgery, bribery, falsification or destruction of records, making false statements, or receiving stolen property;
 - c. Are not presently indicted for or otherwise criminally or civilly charged by a governmental entity (Federal, State or local) with commission of any of the offenses enumerated in paragraph 1b of this certification; and
 - d. Have not within a 3-year period preceding this application/proposal had one or more public transactions (Federal, State or local) terminated for cause or default.
- 2. Where the prospective primary participant is unable to certify to any of the statements in this certification, such prospective participant shall attach an explanation to this proposal.

2. Instructions for Certification - Lower Tier Covered Transactions:

(Applicable to all subcontracts, purchase orders and other lower tier transactions of \$25,000 or more - 49 CFR 29)

- a. By signing and submitting this proposal, the prospective lower tier is providing the certification set out below.
- b. The certification in this clause is a material representation of fact upon which reliance was placed when this transaction was entered into. If it is later determined that the prospective lower tier participant knowingly rendered an erroneous certification, in addition to other remedies available to the Federal Government, the department, or agency with which this transaction originated may pursue available remedies, including suspension and/or debarment.
- c. The prospective lower tier participant shall provide immediate written notice to the person to which this proposal is submitted if at any time the prospective lower tier participant learns that its certification was erroneous by reason of changed circumstances.
- d. The terms "covered transaction," "debarred," "suspended," "ineligible," "primary covered transaction," "participant," "person," "principal," "proposal," and "voluntarily excluded," as used in this clause, have the meanings set out in the Definitions and Coverage sections of rules implementing Executive Order 12549. You may contact the person to which this proposal is submitted for assistance in obtaining a copy of those regulations.
- e. The prospective lower tier participant agrees by submitting this proposal that, should the proposed covered transaction be entered into, it shall not knowingly enter into any lower tier covered transaction with a person who is debarred, suspended, declared ineligible, or voluntarily excluded from participation in this covered transaction, unless authorized by the department or agency with which this transaction originated.
- f. The prospective lower tier participant further agrees by submitting this proposal that it will include this clause titled "Certification Regarding Debarment, Suspension, Ineligibility and Voluntary Exclusion-Lower Tier Covered Transaction," without modification, in all lower tier covered transactions and in all solicitations for lower tier covered transactions.

- g. A participant in a covered transaction may rely upon a certification of a prospective participant in a lower tier covered transaction that is not debarred, suspended, ineligible, or voluntarily excluded from the covered transaction, unless it knows that the certification is erroneous. A participant may decide the method and frequency by which it determines the eligibility of its principals. Each participant may, but is not required to, check the Nonprocurement List.
- h. Nothing contained in the foregoing shall be construed to require establishment of a system of records in order to render in good faith the certification required by this clause. The knowledge and information of participant is not required to exceed that which is normally possessed by a prudent person in the ordinary course of business dealings.
- i. Except for transactions authorized under paragraph e of these instructions, if a participant in a covered transaction knowingly enters into a lower tier covered transaction with a person who is suspended, debarred, ineligible, or voluntarily excluded from participation in this transaction, in addition to other remedies available to the Federal Government, the department or agency with which this transaction originated may pursue available remedies, including suspension and/or debarment.

* * * * *

Certification Regarding Debarment, Suspension, Ineligibility and Voluntary Exclusion--Lower Tier Covered Transactions:

- 1. The prospective lower tier participant certifies, by submission of this proposal, that neither it nor its principals is presently debarred, suspended, proposed for debarment, declared ineligible, or voluntarily excluded from participation in this transaction by any Federal department or agency.
- 2. Where the prospective lower tier participant is unable to certify to any of the statements in this certification, such prospective participant shall attach an explanation to this proposal.

* * * * *

XII. CERTIFICATION REGARDING USE OF CONTRACT FUNDS FOR LOBBYING

(Applicable to all Federal-aid construction contracts and to all related subcontracts which exceed \$100,000 - 49 CFR 20)

- 1. The prospective participant certifies, by signing and submitting this bid or proposal, to the best of his or her knowledge and belief, that:
 - a. No Federal appropriated funds have been paid or will be paid, by or on behalf of the undersigned, to any person for influencing or attempting to influence an officer or employee of any Federal agency, a Member of Congress, an officer or employee of Congress, or an employee of a Member of Congress in connection with the awarding of any Federal contract, the making of any Federal grant, the making of any Federal loan, the entering into of any cooperative agreement, and the extension, continuation, renewal, amendment, or modification of any Federal contract, grant, loan, or cooperative agreement.
 - b. If any funds other than Federal appropriated funds have been paid or will be paid to any person for influencing or attempting to influence an officer or employee of any Federal agency, a Member of Congress, an officer or employee of Congress, or an employee of a Member of Congress in connection with this Federal contract, grant, loan, or cooperative agreement, the undersigned shall complete and submit Standard Form-LLL, "Disclosure Form to Report Lobbying," in accordance with its instructions.
- 2. This certification is a material representation of fact upon which reliance was placed when this transaction was made or entered into. Submission of this certification is a prerequisite for making or entering into this transaction imposed by 31 U.S.C. 1352. Any person who fails to file the required certification shall be subject to a civil penalty of not less than \$10,000 and not more than \$100,000 for each such failure.
- 3. The prospective participant also agrees by submitting his or her bid or proposal that he or she shall require that the language of this certification be included in all lower tier subcontracts, which exceed \$100,000 and that all such recipients shall certify and disclose accordingly.

GENERAL DECISION NC20080011 NC11

Z-12

Date: October 23, 2009

General Decision Number NC20080011 10/23/2009

Superseded General Decision No. NC20070011

State: North Carolina

Construction Type: HIGHWAY

COUNTIES:

Alamance	Durham	Orange
Alexander	Forsyth	Randolph
Buncombe	Franklin	Rowan
Burke	Gaston	Stokes
Cabarrus	Guilford	Union
Catawba	Lincoln	Wake
Cumberland	Mecklenburg	Yadkin
Davidson	New Hanover	
Davie	Onslow	

HIGHWAY CONSTRUCTION PROJECTS (does not include tunnels, building structures in rest area projects, railroad construction, and, bascule, suspension and spandrel arch bridges, bridges designed for commercial navigation, and bridges involving marine construction, and other major bridges).

Modification Number	Publication Date
0	02/08/2008
1	07/25/2008
2	07/24/2009
3	10/23/2009

	Rates	Fringes
CARPENTER	7.63	
CONCRETE FINISHER	7.52	
ELECTRICIAN	10.26	
IRONWORKERS (reinforcing)	9.76	
LABORER		
General	7.25	
Asphalt Lay Down Man	7.25	
Asphalt Raker	7.25	
Form Setter (road)	8.57	
Mason (brick, block, stone)	7.44	
Pipe Layer	7.25	
Power Tool Operator	8.28	
POWER EQUIPMENT OPERATORS		
Asphalt Distributor	7.25	
Asphalt Paver	7.47	
Bulldozer	7.33	
Bulldozer (utility)	7.25	
Concrete Curb Machine	7.25	
Concrete Finishing Machine	7.85	
Concrete Paver	7.25	
Crane, Backhoe, Shovel & Dragline (over 1 yd)	8.16	
Crane, Backhoe, Shovel & Dragline (1 yd and under)	7.25	
Drill Operator	7.34	
Grade Checker	7.25	
Gradeall	8.38	
Grease Person	7.25	
Loader	7.25	
Mechanic	8.47	
Motor Grader (Fine Grade)	8.04	
Motor Grader (Rough Grade)	7.68	
Oiler	7.25	
Roller (Finisher)	7.25	
Roller (Rough)	7.25	
Scraper	7.25	
Screed Asphalt	7.25	
Stone Spreader	7.25	
Stripping Machine Operator	7.25	
Subgrade Machine	7.25	
Sweeper	7.25	
Tractor (Utility)	7.25	
TRUCK DRIVERS		
Trucks – Single Rear Axle	7.25	
Trucks – Multi Rear Axle	7.25	
Trucks – Heavy Duty	9.47	

WELDERS – Receive rate prescribed for craft performing operation to which welding is incidental.

Unlisted classifications needed for work not included within the scope of the classifications listed may be added after award only as provided in the labor standards contract clauses (29 CFR 5.5(a)(1)(ii)).

In the listing above, the "SU" designation means that rates listed under that identifier do not reflect collectively bargained wage and fringe benefit rates. Other designations indicate unions whose rates have been determined to be prevailing.

WAGE DETERMINATION APPEALS PROCESS

1.) Has there been an initial decision in the matter? This can be:

- * an existing published wage determination
- * a survey underlying a wage determination
- * a Wage and Hour Division letter setting forth a position on a wage determination matter
- * a conformance (additional classification and rate) ruling

On survey related matters, initial contact, including requests for summaries of surveys, should be with the Wage and Hour Regional Office for the area in which the survey was conducted because those Regional Offices have responsibility for the Davis-Bacon survey program. If the response from this initial contact is not satisfactory, then the process described in 2.) and 3.) should be followed.

With regard to any other matter not yet ripe for the formal process described here, initial contact should be with the Branch of Construction Wage Determinations. Write to:

Branch of Construction Wage Determinations
Wage and Hour Division
U. S. Department of Labor
200 Constitution Avenue, N.W.
Washington, D.C. 20210

2.) If the answer to the question in 1.) is yes, then an interested party (those affected by the action) can request review and reconsideration from the Wage and Hour Administrator (See 29 CFR Part 1.8 and 29 CFR Part 7). Write to:

Wage and Hour Administrator
U.S. Department of Labor
200 Constitution Avenue, N.W.
Washington, D.C. 20210

The request should be accompanied by a full statement of the interested party's position and by any information (wage payment data, project description, area practice material, etc.) that the requestor considers relevant to the issue.

3.) If the decision of the Administrator is not favorable, an interested party may appeal directly to the Administrative Review Board (formerly the Wage Appeals Board). Write to:

Administrative Review Board
U. S. Department of Labor
200 Constitution Avenue, N.W.
Washington, D.C. 20210

4.) All decisions by the Administrative Review Board are final.

END OF GENERAL DECISION

***** STANDARD SPECIAL PROVISIONS *****

(12-18-07)

DIVISION ONE OF STANDARD SPECIFICATIONS

Division One of the 2006 NCDOT Standard Specifications for Roads and Structures (Standard Specifications) shall apply except as follows:

Definitions: Throughout Division One of the *Standard Specifications*, the term “Contractor” is replaced with “Design-Build Team”, the term “Bidder” is replaced with “Proposer,” the term “Bid” is replaced by “Price Proposal,” and the phrase “lowest Responsible Bidder” is replaced with “responsible Proposer with the lowest adjusted price.” The replacement of “Contractor” with “Design-Build Team” does not apply to Article 102-2. The replacement of the above terms also does not apply when the terms are part of a phrase (e.g. bid bond, prime contractor, total amount bid, etc.)

Deletions: Articles 102-4, 102-10(C)(2), 102-11(A), 103-2(B), 103-4(B), 104-13, and 108-2 of the *Standard Specifications* are deleted from Design-Build Contracts.

Modifications: The remainder of this Standard Special Provision includes modifications to Division One of the *Standard Specifications*.

**SECTION 101
DEFINITION OF TERMS**

Page 1-2, Article 101-3, replace and add certain definitions as follows:

ADDITIONAL WORK

Additional work is that which results from a change or alteration in the contract and for which there are contract unit prices in the original contract or an executed supplemental agreement.

ADVERTISEMENT

The public advertisement inviting Statements of Qualifications for the design and construction of specific projects.

AWARD

The decision of the Board of Transportation to accept the proposal of the selected Design-Build Team for work which is subject to the furnishing of payment and performance bonds, and such other conditions as may be otherwise provided by law, the Request for Proposals, and the *Standard Specifications*.

CONTRACT

The executed agreement between the Department of Transportation and the successful proposer, covering the performance of the work and the compensation therefor.

The term contract is all inclusive with reference to all written agreements affecting a contractual relationship and all documents referred to therein. The contract shall specifically

include, but not be limited to, the Request for Proposals, the Technical Proposal, the Price Proposal, the printed contract form and all attachments thereto, the contract bonds, the plans and associated special provisions prepared by the Design-Build Team, the standard specifications and all supplemental specifications thereto, the standard special provisions and the project special provisions contained in the Request for Proposals, and all executed supplemental agreements, all of which shall constitute one instrument.

DATE OF AVAILABILITY

That date set forth in the Request for Proposals, by which it is anticipated that the Contract will be executed and sufficient design efforts or work sites within the project limits will be available for the Design-Build Team to begin his controlling operations or design.

DESIGN-BUILD

A form of contracting in which the successful proposer undertakes responsibility for both the design and construction of a project.

DESIGN-BUILD TEAM

An individual, partnership, joint venture, corporation or other legal entity that furnishes the necessary design and construction services, whether by itself or through subcontracts.

DESIGN-BUILD PROPOSAL

A proposal to contract consisting of a separately sealed Technical Proposal and a separately sealed Price Proposal submitted in response to a Request for Proposals on a Design-Build project.

PLANS

The project plans, Standard Drawings, working drawings and supplemental drawings, or reproductions thereof, accepted by the Engineer, which show the location, character, dimensions and details of the work to be performed.

(A) Standard Drawings:

Drawings approved for repetitive use, showing details to be used where appropriate. All Standard Drawings approved by the Department plus subsequent revisions and additions. Standard Drawings are available for purchase from:

Randy A. Garris, PE
State Contract Officer
1591 Mail Service Center
Raleigh, NC 27699-1591

(B) Preliminary Plans:

Department-furnished drawings included along with a Request for Proposals, or as developed by the Design-Build Team.

(C) Project Plans:

Construction drawings prepared, sealed and completed by the Design-Build Team, or as provided by the Department, that contain specific details and dimensions peculiar to the work.

(D) Working Drawings and Supplemental Drawings:

Supplemental design sheets, shop drawings, or similar data which the Design-Build Team is required to submit to the Engineer.

(E) As-Constructed Drawings:

Final drawings prepared by the Design-Build Team, documenting the details and dimensions of the completed work.

PRICE PROPOSAL

The offer of a Proposer, submitted on the prescribed forms, to perform the work and furnish the labor and materials at the price quoted.

PROPOSAL (OR REQUEST FOR PROPOSALS)

The paper document provided by the Department that the proposer uses to develop his paper offer to perform the work at designated bid prices.

PROPOSER

An individual, partnership, firm, corporation, LLC, or joint venture formally submitting a Technical Proposal and Price Proposal in response to a Request for Proposals.

RIGHT OF WAY

The land area shown on the plans as right of way within which the project is to be constructed.

SCHEDULE OF VALUES

A schedule of work items necessary to complete work, along with the progress of each work item, primarily for the purpose of partial payments.

TABLE OF QUANTITIES

A listing of work items (corresponding to the items in the Trns*port pay item list) that contributes to a project completion. The table shall include estimated quantities for each work item.

TECHNICAL PROPOSAL

A submittal from a proposer, in accordance with requirements of the Request for Proposals, for the purpose of final selection.

SECTION 102 PROPOSAL REQUIREMENTS AND CONDITIONS

Page 1-11, delete Article 102-1 and replace with the following:

102-1 INVITATION TO BID

After the advertisement has been made, an invitation to bid will be mailed to known prequalified contractors and any other contracting firms, material suppliers, and other interested parties who have requested they be placed on the invitation to bid mailing list informing them that bids will be received for the construction of specific projects. Such invitation will indicate the contract identification number, length, locations, and descriptions; a general summary of the items of work to be performed; and information on how to receive a Request for Qualifications.

All projects will be advertised in daily newspapers throughout the state prior to the bid opening.

Page 1-15, delete Article 102-3 and replace with the following:

102-3 CONTENTS OF REQUEST FOR PROPOSALS

A Request for Proposals will be furnished by the Department to the selected proposers from among the respondents to the Request for Qualifications. Each Request for Proposals will be marked on the front cover by the Department with an identifier of the Proposer to whom it is being furnished. This Request for Proposals will state the location of the project and will show a schedule of contract items for which Technical and Price Proposals are invited. It will set forth the date and time Technical and Price Proposals are to be submitted and will be opened. The Request for Proposals will also include any special provisions or requirements that vary from or are not contained in any preliminary design information or standard specifications.

The Request for Proposals will also include the printed contract forms and signature sheets for execution by both parties to the contract. In the event the Proposer is awarded the contract, execution of the Request for Proposals by the Proposer is considered the same as execution of the contract.

Standard specifications, sealed plans specifically identified as the Department's responsibility and other documents designated in the Request for Proposals shall be considered a part of the Request for Proposals whether or not they are attached thereto. All papers bound with the proposal are necessary parts thereof and shall not be detached, taken apart, or altered.

The names and identity of each prospective Proposer that receives a copy of the Request for Qualifications for the purposes of submitting a Statement of Qualifications shall be made public, except that a potential Proposer who obtains a Request for Qualifications may, at the time of ordering, request that his name remain confidential.

Up to three copies of the Request for Proposals will be furnished to each prospective Proposer. Additional copies may be purchased for the sum of \$25 each. The copy marked with the Proposer's name and prequalification number shall be returned to the Department.

Page 1-16, Article 102-6, replace the first paragraph with the following:

The Proposer shall examine carefully the site of the work contemplated, the preliminary plans and specifications, and the Request for Proposals. The submission of a Technical Proposal and a Price Proposal shall be conclusive evidence that the Proposer has investigated and is satisfied as to the conditions to be encountered; as to the character, quality, and scope of work to be performed; the quantities of materials to be furnished; and as to the conditions and requirements of the proposed contract.

Page 1-17, delete Article 102-7 and replace with following:

102-7 SUBSURFACE INVESTIGATION REPORT

The Subsurface Investigation and report was made for the purpose of information only.

If a subsurface investigation report is available on this project, a copy may be obtained by the prospective proposers upon request.

The subsurface investigation on which the report is based was made for the purpose of information only. The various field boring logs, rock cores, and soil test data available may be reviewed or inspected in Raleigh at the office of the Geotechnical Unit. Neither the subsurface investigation report nor the field boring logs, rock cores, or soil test data is part of the contract.

General soil and rock strata descriptions and indicated boundaries are based on a geotechnical interpretation of all available subsurface data and may not necessarily reflect the actual subsurface conditions between borings or between sampled strata within the borehole. The laboratory sample data and the in situ (in-place) test data can be relied on only to the degree of reliability inherent in the standard test method. The observed water levels or soil moisture conditions indicated in the subsurface investigations are as recorded at the time of the investigation. These water levels or soil moisture conditions may vary considerably with time according to climatic conditions including temperature, precipitation, and wind, as well as other nonclimatic factors.

The Proposer is cautioned that details shown in the subsurface investigation report are preliminary only. The Department does not warrant or guarantee the sufficiency or accuracy of the investigation made, nor the interpretations made or opinions of the Department as to the type of materials and conditions that may be encountered. The proposer is cautioned to make such independent subsurface investigations, as he deems necessary to satisfy himself as to conditions to be encountered on this project. The Design-Build Team shall have no claim for additional compensation or for an extension of time for any reason resulting from the actual conditions encountered at the site differing from those indicated in the subsurface investigation.

Pages 1-17, delete Article 102-8 and replace with the following:

102-8 PREPARATION AND SUBMISSION OF BIDS

All Price Proposals shall be prepared and submitted in accordance with the following requirements:

1. The Request for Proposals provided by the Department shall be used and shall not be taken apart or altered. The Price Proposal shall be submitted on the same form, which has

been furnished to the Proposer by the Department as identified by the Proposer's name marked on the front cover by the Department.

2. All entries including signatures shall be written in ink.
3. The Proposer shall submit a lump sum or unit price for every item in the Price Proposal. The lump sum or unit prices bid for the various contract items shall be written in figures.
4. An amount bid shall be entered in the Request for Proposals for every item and the price shall be written in figures in the "Amount Bid" column in the Request for Proposals.
5. The total amount bid shall be written in figures in the proper place in the Request for Proposals. The total amount bid shall be determined by adding the amounts bid for each lump sum item.
6. Changes in any entry shall be made by marking through the entry in ink and making the correct entry adjacent thereto in ink. A representative of the Proposer shall initial the change in ink.
7. The Price Proposal shall be properly executed. In order to constitute proper execution, the Price Proposal shall be executed in strict compliance with the following:
 - a. If a Price Proposal is by an individual, it shall show the name of the individual and shall be signed by the individual with the word "Individually" appearing under the signature. If the individual operates under a firm name, the bid shall be signed in the name of the individual doing business under the firm name.
 - b. If the Price Proposal is by a corporation, it shall be executed in the name of the corporation by the President, Vice President, or Assistant Vice President. It shall be attested by the Secretary or Assistant Secretary. The seal of the corporation shall be affixed. If the Price Proposal is executed on behalf of a corporation in any other manner than as above, a certified copy of the minutes of the Board of Directors of said corporation authorizing the manner and style of execution and the authority of the person executing shall be attached to the Price Proposal or shall be on file with the Department.
 - c. If the Price Proposal is made by a partnership, it shall be executed in the name of the partnership by one of the general partners.
 - d. If the Price Proposal is made by a Limited Liability Company (LLC), it shall be signed by the manager and notarized.
 - e. If the Price Proposal is made by a joint venture, it shall be executed by each of the joint venturers in the appropriate manner set out above. In addition, the execution by the joint venturers shall appear below their names.
 - f. The Price Proposal execution shall be notarized by a notary public whose commission is in effect on the date of execution. Such notarization shall be applicable both to the Price Proposal and to the non-collusion affidavit which is part of the signature sheets.
8. The Price Proposal shall not contain any unauthorized additions, deletions, or conditional bids.

9. The Proposer shall not add any provision reserving the right to accept or reject an award, or to enter into a contract pursuant to an award.
10. The Price Proposal shall be accompanied by a bid bond on the form furnished by the Department or by a bid deposit. The bid bond shall be completely and properly executed in accordance with the requirements of Article 102-11. The bid deposit shall be a certified check or cashier check in accordance with Article 102-11.
11. The Price Proposal shall be placed in a sealed envelope and shall have been delivered to and received by the Department prior to the time specified in the Request for Proposals.

Page 1-22, delete Article 102-12 and replace with the following:

102-12 DELIVERY OF BIDS

All Price Proposals shall be placed in a sealed envelope having the name and address of the Proposer, and the statement " Price Proposal for the Design/Build of State Highway Project No. _____ in _____County(ies)" on the outside of the envelope. If delivered by mail, the sealed envelope shall be placed in another sealed envelope and the outer envelope addressed to the Contract Officer as stated in the Request for Proposals. The outer envelope shall also bear the statement "Price Proposal for the Design/Build of State Highway Project No. _____". All Technical Proposals shall be placed in a sealed envelope having the name and address of the Proposer, and the statement "Technical Proposal for the Design/Build of State Highway Project No. _____ in _____County(ies)" on the outside of the envelope. If delivered by mail, the sealed envelope shall be placed in another sealed envelope and the outer envelope addressed to the Contract Officer as stated in the Request for Proposal. The outer envelope shall also bear the statement "Technical Proposal for the Design/Build of State Highway Project No. _____". If delivered in person on or before the due date, the sealed envelope shall be delivered to the office of the Contract Officer as indicated in the Request for Proposals. Price Proposals and Technical Proposals shall be submitted in accordance with the project special provision "Submittal of Proposals" contained elsewhere in this Request for Proposals.

All Price Proposals and Technical Proposals shall be delivered prior to the time specified in the Request for Proposals. Price proposals and Technical Proposals received after such time will not be accepted and will be returned to the Proposer unopened.

Pages 1-22, delete Article 102-13 and replace with the following:

102-13 WITHDRAWAL OR REVISION OF BIDS

A Design-Build Team will not be permitted to withdraw its Technical and Price Proposals after they have been submitted to the Department, unless allowed under Article 103-3 or unless otherwise approved by the State Highway Administrator.

Page 1-23, delete Article 102-14 and replace with the following:

102-14 RECEIPT AND OPENING OF BIDS

Price Proposals will be opened and read publicly at the time and place indicated in the Request for Proposals. The scores of the previously conducted evaluation of the Technical Proposals will also be read publicly in accordance with the procedures outlined in the Request

for Proposals. Proposers, their authorized agents, and other interested parties are invited to be present.

Page 1-23, Article 102-15, Replace the 1st paragraph with the following:

102-15 REJECTION OF BIDS

Any Price Proposal submitted which fails to comply with any of the requirements of Articles 102-8, 102-10 or 102-11, or with the requirements of the project scope and functional specifications shall be considered irregular and may be rejected. A Price Proposal that does not contain costs for all proposal items shall be considered irregular and may be rejected.

**SECTION 103
AWARD AND EXECUTION OF CONTRACT**

Page 1-25, delete Article 103-1 and replace with the following:

103-1 CONSIDERATION OF PRICE PROPOSALS

After the Price Proposals are opened and read, they will be tabulated. The Price Proposal and score of the Technical Proposal will be made available in accordance with procedures outlined in the Request for Proposals. In the event of errors, omissions, or discrepancies in the costs, corrections to the Price Proposal will be made in accordance with the provisions of Article 103-2. Such corrected costs will be used to determine the lowest adjusted price.

After the reading of the Price Proposals and technical scores, the Department will calculate the lowest adjusted price as described in the “Selection Procedure” section of the Request for Proposals.

The right is reserved to reject any or all Price Proposals, to waive technicalities, to request the Proposer with the lowest adjusted price to submit an up-to-date financial and operating statement, to advertise for new proposals, or to proceed to do the work otherwise, if in the judgment of the Board, the best interests of the State will be promoted thereby.

Page 1-26, Subarticle 103-2(A), add items (7) and (8) as follows:

- (7) Discrepancy in the “Total Amount Bid” and the addition of the “Amount Bid” for each line Item**

In the case of the Total Amount Bid does not equal the summation of each Amount Bid for the line items, the summation of each Amount Bid for the line items shall be deemed to be the correct total for the entire project.

- (8) Omitted Total Amount Bid –Amount Bid Completed**

If the Total Amount Bid is not completed and the Amount Bid for all line items is completed the Total Amount Bid shall be the summation of the Amount Bid for all line items.

Page 1-29, delete Article 103-6 and replace with the following:

103-6 RETURN OF BID BOND OR BID DEPOSIT

Checks that have been furnished as a bid deposit will be retained until after the contract bonds have been furnished by the successful proposer, at which time Department of Transportation warrants in the equivalent amount of checks that were furnished as a bid deposit will be issued.

Paper bid bonds will be retained by the Department until the contract bonds are furnished by the successful proposer, after which all such bid bonds will be destroyed unless the individual bid bond form contains a note requesting that it be returned to the proposer or the Surety.

Page 1-30, delete Article 103-9 and replace with the following:

103-9 FAILURE TO FURNISH CONTRACT BONDS

The successful proposer's failure to file acceptable bonds within 14 calendar days after the notice of award is received by him shall be just cause for the forfeiture of the bid bond or bid deposit and rescinding the award of the contract. Award may then be made to the responsible proposer with the next lowest adjusted price or the work may be readvertised and constructed under contract or otherwise, as the Board of Transportation may decide.

**SECTION 104
SCOPE OF WORK**

Page 1-30, delete Article 104-1 and replace with the following:

104-1 INTENT OF CONTRACT

The intent of the contract is to prescribe the work or improvements that the Design-Build Team undertakes to perform, in full compliance with the contract. In case the method or character of any part of the work is not covered by the contract, this section shall apply. The Design-Build Team shall perform all work in accordance with the contract or as may be modified by written orders, and shall do such special, additional, extra, and incidental work as may be considered necessary to complete the work to the full intent of the contract. Unless otherwise provided elsewhere in the contract, the Design-Build Team shall furnish all implements, machinery, equipment, tools, materials, supplies, transportation, and labor necessary for the design, prosecution and completion of the work.

Page 1-31, Article 104-3, replace “plans or details of construction” with “contract” in all instances within this Article.

Page 1-40, Article 104-10, replace the first paragraph with the following:

104-10 MAINTENANCE OF THE PROJECT

The Design-Build Team shall maintain the project from the date of beginning construction on the project until the project is finally accepted. All existing and constructed guardrail / guiderail

within the project limits shall be included in this maintenance. This maintenance shall be continuous and effective and shall be prosecuted with adequate equipment and forces to the end that all work covered by the contract is kept in satisfactory and acceptable conditions at all times. The Design-Build Team shall perform weekly inspections of guardrail and guiderail and shall report damages to the Engineer on the same day of the weekly inspection. Where damaged guardrail or guiderail is repaired or replaced as a result of maintaining the project in accordance with this Article, such repair or replacement shall be performed within 7 consecutive calendar days of such inspection report.

Page 1-41, Article 104-10, add the following after the last paragraph:

The Design-Build Team will not be compensated for performance of weekly inspections and damage reports for the guardrail / guiderail. Other maintenance activities for existing guardrail / guiderail will be handled in accordance with Articles 104-7 and 104-8.

SECTION 105 CONTROL OF WORK

Pages 1-46, delete Article 105-2 and replace with the following:

105-2 PLANS AND WORKING DRAWINGS

All plans shall be supplemented by such approved working drawings as are necessary to adequately control the work. Working drawings furnished by the Design-Build Team and approved by the Engineer shall consist of such detailed drawings as may be required to adequately control the work. They may include stress sheets, shop drawings, erection drawings, falsework drawings, cofferdam drawings, bending diagrams for reinforcing steel, catalog cuts, or any other supplementary drawings or similar data required of the Design-Build Team. When working drawings are approved by the Engineer, such approval shall not operate to relieve the Design-Build Team of any of his responsibility under the contract for the successful completion of the work.

Changes on shop drawings after approval and/or distribution shall be subject to the approval of the Engineer and he shall be furnished a record of such changes.

Page 1-47, Article 105-3, add the following after the 3rd paragraph:

The Design-Build Team shall bear all the costs of providing the burden of proof that the nonconforming work is reasonable and adequately addresses the design purpose. The Design-Build Team shall bear all risk for continuing with nonconforming work in question until it is accepted.

The Engineer may impose conditions for acceptance of the nonconforming work. The Design-Build Team shall bear all costs for fulfilling the conditions.

The decisions whether the product satisfies the design purpose, whether the nonconforming work is reasonably acceptable and the conditions for acceptance are at the sole discretion of the Engineer.

Pages 1-47, delete Article 105-4 and replace with the following:

105-4 COORDINATION OF PLANS, SPECIFICATIONS, SUPPLEMENTAL SPECIFICATIONS, AND SPECIAL PROVISIONS

The Request for Proposals, all Plans, the Standard Specifications, and all supplementary documents are essential parts of the contract and a requirement occurring in one is as binding as though occurring in all. They are intended to be complementary and to describe and provide for a complete work.

In case of discrepancy or conflict, the order in which they govern shall be as follows:

- (A) Request for Proposals
- (B) Technical Proposal from the Design-Build Team
- (C) Accepted Plans and Details from the Design-Build Team, or sealed plans provided by the Department, as applicable
- (D) Standard Drawings
- (E) Standard Specifications

Where dimensions on the plans are given or can be computed from other given dimensions they shall govern over scaled dimensions.

The Design-Build Team shall take no advantage of any error or omission in the plans, estimated quantities, or specifications. In the event the Design-Build Team discovers an error or omission, he shall immediately notify the Engineer.

Page 1-50, delete Article 105-9 and replace with the following:

105-9 CONSTRUCTION STAKES, LINES, AND GRADES

The Design-Build Team shall be responsible for any surveying, construction staking and layout required in the performance of the work. He will be responsible for the accuracy of lines, slopes, grades and other engineering work which he provides under this contract. Unless otherwise specified in the Request for Proposals, no measurement or direct payment will be made for this work. The cost shall be considered as included in other contract items.

**SECTION 106
CONTROL OF MATERIAL**

Page 1-56, Article 106-2, add the following after the second paragraph:

Prior to beginning construction, the Design-Build Team shall provide a Table of Quantities as described in Article 101-3 of these specifications.

The Table of Quantities Work Items shall correspond to Pay Items as defined in the Standard Specifications. These Work Items have associated Materials and Conversion Factors. For non-standard Work Items, a Generic Work Item with the correct Unit of Measure and in an appropriate category will be used. For example, "GENERIC TRAFFIC CONTROL ITEM – EA" or "GENERIC RETAINING WALL ITEM – LF". For these Generic Work Items, Materials must be defined and appropriate conversion factors submitted.

An initial Table of Quantities shall be submitted no later than 30 calendar days after the date of award. The Table of Quantities shall be updated and resubmitted within 14 days of when a set of Plans is sealed as Release for Construction (RFC) Plans, and whenever there are substantial changes to the Quantities on previously incorporated RFC Plans.

Page 1-58, Article 106-6, replace “specifications” with “contract” as the last word of the 1st paragraph.

Page 1-58, Article 106-6(C), replace the 2nd paragraph with the following:

Where the Department agrees to inspect or test materials during their production or at the source of supply, the Design-Build Team shall bear the cost of testing performed on materials ordered by him but not incorporated into the project. For items normally pretested by the Department, the Design-Build Team shall provide a minimum of 30 days notice prior to the beginning of production of the items for this project along with final approved shop drawings.

SECTION 107 LEGAL RELATIONS AND RESPONSIBILITY TO PUBLIC

Page 1-69, Article 107-18, in the last sentence of the first paragraph, replace the word “legally” with the word “contractually”.

Page 1-69, delete Article 107-19 and replace with the following:

107-19 FURNISHING RIGHT OF WAY

The responsibility for coordinating the securing of all necessary rights of way is as outlined in the Request for Proposals.

SECTION 108 PROSECUTION AND PROGRESS

Page 1-71, Article 108-1, add the following sentence to the end of the 1st paragraph:

The Design-Build Team shall not commence work prior to execution of the contract by both the Department and the Design-Build Team.

Page 1-72, delete Article 108-3 and replace with the following:

108-3 PRECONSTRUCTION AND PRE-DESIGN CONFERENCES

The selected Design-Build Team shall meet with the Engineer for a pre-design conference concerning the design phase of the work. This conference shall be held prior to the commencement of work, as it is determined according to Article 108-1, and will be scheduled by the Engineer. At the predesign conference, the Design-Build Team shall furnish authorized signature forms and a list of any proposed subcontractors associated with the design of the project.

A preconstruction conference shall be held at least 10 working days before construction activity begins. This second conference, concerning the construction phase, shall also be scheduled by the Engineer. The Design-Build Team shall give the Engineer a minimum of 45 days notice before he plans to begin construction activities. This will allow the Engineer time for any environmental agency representatives involved in the permitting process, as well as any other pertinent entities, to be scheduled to attend the preconstruction conference. If the Design-Build Team is responsible for utilities in accordance with Article 105-8 and the Request for Proposals, he shall be responsible for coordinating with the Engineer in scheduling their attendance and for notifying them. The Design-Build Team shall also be responsible for coordinating with the Engineer in scheduling the attendance of subcontractors and others deemed appropriate, and for notifying them.

At the preconstruction conference, a list of any proposed subcontractors and major material suppliers associated with the construction of the project will be submitted.

If the contract has a DBE requirement, the Design-Build Team shall submit copies of completed and signed DBE subcontracts, purchase orders, or invoices to the Department.

The Design-Build Team shall submit a traffic control plan in accordance with Article 1101-5 and the Request for Proposals. The Design-Build Team shall designate an employee who is competent and experienced in traffic control to implement and monitor the traffic control plan. The qualifications of the designated employee must be satisfactory to the Engineer.

The Design-Build Team shall submit a safety plan and designate an employee as Safety Supervisor.

Both plans shall be submitted at the preconstruction conference and must be satisfactory to the Engineer. Should the design plan include activities that would place personnel on the work site, traffic control and safety plans for those activities shall be submitted at the predesign conference.

During the preconstruction conference, the Engineer will designate a Department employee or employees who will be responsible to see that the traffic control plans and any alterations thereto are implemented and monitored to the end that traffic is carried through the work in an effective manner. If approved by the Engineer, the Design-Build Team may designate one employee to be responsible for both the traffic control and safety plans. The Design-Build Team shall not designate its superintendent as the responsible person for either the traffic control plan or the safety plan, unless approved by the Engineer.

If the project requires that Design-Build Team or State personnel work from falsework, within shoring, or in any other hazardous area the Design-Build Team shall submit, as part of the Design-Build Team's safety plan, specific measures it will use to ensure worker safety.

The Design-Build Team shall also submit a program for erosion control and pollution prevention on all projects involving clearing and grubbing, earthwork, structural work, or other construction, when such work is likely to create erosion or pollution problems.

If the Design-Build Team fails to provide the required submissions, the Engineer may order the preconstruction conference suspended until such time as they are furnished. Work shall not begin until the preconstruction conference has been concluded and the safety plan has been approved, unless authorized by the Engineer. The Design-Build Team shall not be entitled to

additional compensation or an extension of contract time resulting from any delays due to such a suspension.

The Design-Build Team shall designate a qualified employee as Quality Control Manager. The Quality Control Manager shall be responsible for implementing and monitoring the quality control requirements of the project.

Page 1-72, Article 108-4, add the following sentence to the end of this article:

The Design-Build Team shall record the proceedings of these conferences and distribute the final minutes of the conferences to all attendees.

Page 1-74, Article 108-6, replace “40 percent” with “30 percent” in the 1st paragraph.

Page 1-74, Article 108-6, delete the second paragraph and replace with the following:

In any event, the Contractor shall perform with his own organization work amounting to not less than 25% of the difference between the total amount bid and the value of specialty items that have been sublet.

Pages 1-75, delete Article 108-8 and replace with the following:

108-8 FAILURE TO MAINTAIN SATISFACTORY PROGRESS

The Engineer will check the Design-Build Team’s progress at the time each partial pay request is received. The Design-Build Team’s progress may be considered as unsatisfactory if, according to the Progress schedule, the projected finish date for all work exceeds the scheduled finish date by more than 10%.

When the Design-Build Team's progress is found to be unsatisfactory as described above, the Engineer may make written demand of the Design-Build Team to state in writing the reason for the unsatisfactory progress and produce such supporting data as the Engineer may require or the Design-Build Team may desire to submit. The Engineer will consider the justifications submitted by the Design-Build Team and extensions of the completion date that have or may be allowed in accordance with Article 108-10(B).

When the Design-Build Team cannot satisfactorily justify the unsatisfactory progress the Engineer may invoke one or more of the following sanctions:

1. Withhold anticipated liquidated damages from amounts currently due or which become due.
2. Remove the Design-Build Team and individual managing firms of the Design-Build Team and/or prequalified design firms from the Department’s Prequalified Bidders List.

When any of the above sanctions have been invoked, they shall remain in effect until rescinded by the Engineer.

Page 1-79, Article 108-10(B), add the following as the first paragraph:

Only delays to activities which affect the completion date or intermediate contract date will be considered for an extension of contract time. No extensions will be granted until a delay

occurs which impacts the project's critical path and extends the work beyond the contract completion date or intermediate completion date. Any extension to the completion date or intermediate contract date will be based on the number of calendar days the completion date or intermediate completion date is impacted as determined by the Engineer's analysis.

Pages 1-79, delete Subarticle 108-10(B)(1) in its entirety.

Page 1-83, Article 108-13, delete bullet (E)(2) in its entirety.

SECTION 109 MEASUREMENT AND PAYMENT

Page 1-85, Article 109-2, delete the last sentence of the 1st paragraph and replace with the following:

Payment to the Design-Build Team will be made only for the work completed, certified and accepted in accordance with the terms of the contract.

Pages 1-90, delete Article 109-4(A) and replace with the following:

109-4 PARTIAL PAYMENTS

(A) General:

Partial payments will be based upon progress estimates prepared by the Engineer at least once each month on the date established by the Engineer. Partial payments may be made twice each month if in the judgment of the Engineer the amount of work performed is sufficient to warrant such payment. No partial payment will be made when the total value of work performed since the last partial payment amounts to less than \$10,000.00. Partial payments will be approximate only and will be subject to correction in the final estimate and payment.

When the contract includes one lump sum price for the entire work required by the contract, partial payments for the lump sum design-build price shall be based on a certified Schedule of Values submitted by the successful Design-Build Team and approved by the Engineer. The certification shall indicate the Design-Build Team has reviewed the information submitted and the information accurately represents the work performed for which payment is requested. The certified Schedule of Values shall be submitted no later than 30 calendar days after the date of award. Each item on the certified Schedule of Values shall be assigned a cost and quantity and shall be identified as an activity on the progress schedule. A revised certified Schedule of Values shall be submitted with each update of the Progress schedule as described in Article 108-2 or when requested by the Engineer. A certified copy of the Table of Quantities shall also be submitted with each payment request. The certification of the Table of Quantities shall indicate the Design-Build Team has reviewed the information submitted and the information accurately represent the materials for the work performed for which payment is requested.

When the contract includes lump sum items for portions of the work required by the contract, and the applicable section of the Specifications or Request for Proposals specify the means by which the total amount bid be included in the partial pay estimates, the Engineer will determine amounts due on the partial pay estimate in accordance with the applicable portion of the Specifications or Request for Proposals.

The Engineer will withhold an amount sufficient to cover anticipated liquidated damages as determined by the Engineer.

Page 1-92, Subarticle 109-5(D), delete the 4th and 5th paragraphs and replace with the following:

Partial payments will not be made on seed or any living or perishable plant materials.

Partial payment requests shall not be submitted by the Design-Build Team until those items requested have corresponding signed and sealed RFC plans accepted by the Department.

Pages 1-94, Article 109-10, add the following as bullets (E) and (F) under the 1st paragraph.

- (E) As-constructed plans or other submittals as required by the Contract.
- (G) Documents or guarantees to support any warranty provided by the Design Build Team.

ITEMIZED PROPOSAL FOR CONTRACT No. C 202383

Jun 08, 2009 10:17 am

Page 1 of 1

County: Rowan, Davidson

Line #	Item Number #	Sec #	Description	Quantity	Unit Cost	Amount
ROADWAY ITEMS						
0001	0000900000-N	SP	GENERIC MISCELLANEOUS ITEM DESIGN AND CONSTRUCTION	Lump Sum	L.S.	

1017/Jun08/Q1.0/D 900000 /E1

Total Amount Of Bid For Entire Project: _____

FUEL USAGE FACTOR CHART AND ESTIMATE OF QUANTITIES

Description of Work	Units	Fuel Usage Factor Diesel #2	Estimate of Quantities
Unclassified Excavation	Gal / CY	0.29	_____ CY
Borrow Excavation	Gal / CY	0.29	_____ CY
Aggregate Base Course Aggregate for Cement Treated Base Course Portland Cement for Cement Treated Base Course	Gal / Ton	0.55	_____ Tons
Asphalt Concrete Base Course Asphalt Concrete Intermediate Course Asphalt Concrete Surface Course Open-Graded Asphalt Friction Course Sand Asphalt Surface Course, Type F-1	Gal / Ton	2.90	_____ Tons
Portland Cement Concrete Pavement Structural Concrete (cast-in-place only) Concrete Shoulders Adjacent to Pavement	Gal / CY	0.98	_____ CY

The above quantities represent a reasonable estimate of the total quantities anticipated, for each item, as pertaining to fuel price adjustments, and is representative of the design proposed in the Technical Proposal submitted under separate cover.

Or

The Design-Build Team elects not to pursue reimbursement for Fuel Price Adjustments on this project.

The information submitted on this sheet is claimed as a “Trade Secret” in accordance with the requirements of G.S. 66-152(3) until such time as the Price Proposal is opened.

Signature, Title

Dated

Print Name, Title

(Submit a copy of this sheet in a separate sealed package with the outer wrapping clearly marked “Fuel Price Adjustment” and deliver with the Technical and Cost Proposal.)

LISTING OF DBE SUBCONTRACTORS

Sheet ____ of ____

FIRM NAME AND ADDRESS	ITEM NO.	ITEM DESCRIPTION	(*) AGREED UPON UNIT PRICE	DOLLAR VOLUME OF SUBLET ITEM
CONTRACT NO. _____		COUNTY _____		FIRM _____

THIS FORM MUST BE COMPLETED IN ORDER FOR THE BID TO BE CONSIDERED RESPONSIVE AND BE PUBLICLY READ.
 BIDDERS WITH NO DBE PARTICIPATION MUST SO INDICATE THIS ON THE FORM BY ENTERING THE WORD OR NUMBER ZERO.

LISTING OF DBE SUBCONTRACTORS

Sheet ____ of ____

FIRM NAME AND ADDRESS	ITEM NO.	ITEM DESCRIPTION	(*) AGREED UPON UNIT PRICE	DOLLAR VOLUME OF SUBLET ITEM
CONTRACT NO. _____		COUNTY _____		FIRM _____

LISTING OF DBE SUBCONTRACTORS

Sheet ____ of ____

FIRM NAME AND ADDRESS	ITEM NO.	ITEM DESCRIPTION	(*) AGREED UPON UNIT PRICE	DOLLAR VOLUME OF SUBLET ITEM
CONTRACT NO. _____		COUNTY _____	FIRM _____	

**EXECUTION OF BID
NON-COLLUSION AFFIDAVIT, DEBARMENT CERTIFICATION AND GIFT BAN CERTIFICATION**

CORPORATION

The person executing the bid, on behalf of the Bidder, being duly sworn, solemnly swears (or affirms) that neither he, nor any official, agent or employee of the bidder has entered into any agreement, participated in any collusion, or otherwise taken any action which is in restraint of free competitive bidding in connection with any bid or contract, and that the Bidder intends to do the work with its own bonafide employees or subcontractors and is not bidding for the benefit of another contractor.

In addition, execution of this bid in the proper manner also constitutes the Bidder's certification of status under penalty of perjury under the laws of the United States in accordance with the Debarment Certification attached, provided that the Debarment Certification also includes any required statements concerning exceptions that are applicable.

N.C.G.S. § 133-32 and Executive Order 24 prohibit the offer to, or acceptance by, any State Employee of any gift from anyone with a contract with the State, or from any person seeking to do business with the State. By execution of any response in this procurement, you attest, for your entire organization and its employees or agents, that you are not aware that any such gift has been offered, accepted, or promised by any employees of your organization.

SIGNATURE OF CONTRACTOR

_____ Full name of Corporation

_____ Address as prequalified

Attest _____
Secretary/Assistant Secretary
Select appropriate title

By _____
President/Vice President/Assistant Vice President
Select appropriate title

_____ Print or type Signer's name

_____ Print or type Signer's name

CORPORATE SEAL

AFFIDAVIT MUST BE NOTARIZED

NOTARY SEAL

Subscribed and sworn to before me this the
_____ day of _____, 20_____

_____ Signature of Notary Public

Of _____ County

State of _____

My Commission Expires _____

**EXECUTION OF BID
NON-COLLUSION AFFIDAVIT, DEBARMENT CERTIFICATION AND GIFT BAN CERTIFICATION**

PARTNERSHIP

The person executing the bid, on behalf of the Bidder, being duly sworn, solemnly swears (or affirms) that neither he, nor any official, agent or employee of the bidder has entered into any agreement, participated in any collusion, or otherwise taken any action which is in restraint of free competitive bidding in connection with any bid or contract, and that the Bidder intends to do the work with its own bonafide employees or subcontractors and is not bidding for the benefit of another contractor.

In addition, execution of this bid in the proper manner also constitutes the Bidder's certification of status under penalty of perjury under the laws of the United States in accordance with the Debarment Certification attached, provided that the Debarment Certification also includes any required statements concerning exceptions that are applicable.

N.C.G.S. § 133-32 and Executive Order 24 prohibit the offer to, or acceptance by, any State Employee of any gift from anyone with a contract with the State, or from any person seeking to do business with the State. By execution of any response in this procurement, you attest, for your entire organization and its employees or agents, that you are not aware that any such gift has been offered, accepted, or promised by any employees of your organization.

SIGNATURE OF CONTRACTOR

_____ Full Name of Partnership

_____ Address as Prequalified

_____ By _____
Signature of Witness Signature of Partner

_____ Print or type Signer's name _____ Print or type Signer's name

AFFIDAVIT MUST BE NOTARIZED

Subscribed and sworn to before me this the
day of _____ 20_____.

NOTARY SEAL

_____ Signature of Notary Public

of _____ County

State of _____

My Commission Expires: _____

**EXECUTION OF BID
NON-COLLUSION AFFIDAVIT, DEBARMENT CERTIFICATION AND GIFT BAN CERTIFICATION
LIMITED LIABILITY COMPANY**

The person executing the bid, on behalf of the Bidder, being duly sworn, solemnly swears (or affirms) that neither he, nor any official, agent or employee of the bidder has entered into any agreement, participated in any collusion, or otherwise taken any action which is in restraint of free competitive bidding in connection with any bid or contract, and that the Bidder intends to do the work with its own bonafide employees or subcontractors and is not bidding for the benefit of another contractor.

In addition, execution of this bid in the proper manner also constitutes the Bidder's certification of status under penalty of perjury under the laws of the United States in accordance with the Debarment Certification attached, provided that the Debarment Certification also includes any required statements concerning exceptions that are applicable.

N.C.G.S. § 133-32 and Executive Order 24 prohibit the offer to, or acceptance by, any State Employee of any gift from anyone with a contract with the State, or from any person seeking to do business with the State. By execution of any response in this procurement, you attest, for your entire organization and its employees or agents, that you are not aware that any such gift has been offered, accepted, or promised by any employees of your organization.

SIGNATURE OF CONTRACTOR

Full Name of Firm

Address as Prequalified

Signature of Manager

Signature of Witness

Individually

Print or type Signer's name

Print or type Signer's Name

AFFIDAVIT MUST BE NOTARIZED

Subscribed and sworn to before me this the

NOTARY SEAL

_____ day of _____ 20__.

Signature of Notary Public

of _____ County

State of _____

My Commission Expires: _____

EXECUTION OF BID
NON-COLLUSION AFFIDAVIT, DEBARMENT CERTIFICATION AND GIFT BAN CERTIFICATION
JOINT VENTURE (2) or (3)

The person executing the bid, on behalf of the Bidder, being duly sworn, solemnly swears (or affirms) that neither he, nor any official, agent or employee of the bidder has entered into any agreement, participated in any collusion, or otherwise taken any action which is in restraint of free competitive bidding in connection with any bid or contract, and that the Bidder intends to do the work with its own bonafide employees or subcontractors and is not bidding for the benefit of another contractor.

In addition, execution of this bid in the proper manner also constitutes the Bidder's certification of status under penalty of perjury under the laws of the United States in accordance with the Debarment Certification attached, provided that the Debarment Certification also includes any required statements concerning exceptions that are applicable.

N.C.G.S. § 133-32 and Executive Order 24 prohibit the offer to, or acceptance by, any State Employee of any gift from anyone with a contract with the State, or from any person seeking to do business with the State. By execution of any response in this procurement, you attest, for your entire organization and its employees or agents, that you are not aware that any such gift has been offered, accepted, or promised by any employees of your organization.

SIGNATURE OF CONTRACTOR

Instructions: 2 Joint Venturers Fill in lines (1), (2) and (3) and execute. 3 Joint Venturers Fill in lines (1), (2), (3) and (4) and execute. On Line (1), fill in the name of the Joint Venture Company. On Line (2), fill in the name of one of the joint venturers and execute below in the appropriate manner. On Line (3), print or type the name of the other joint venturer and execute below in the appropriate manner. On Line (4), fill in the name of the third joint venturer, if applicable and execute below in the appropriate manner.

(1) Name of Joint Venture

(2) Name of Contractor

Address as prequalified

Signature of Witness or Attest By Signature of Contractor
Print or type Signer's name Print or type Signer's name

If Corporation, affix Corporate Seal and

(3) Name of Contractor

Address as prequalified

Signature of Witness or Attest By Signature of Contractor
Print or type Signer's name Print or type Signer's name

If Corporation, affix Corporate Seal and

(4) Name of Contractor (for 3 Joint Venture only)

Address as prequalified

Signature of Witness or Attest By Signature of Contractor
Print or type Signer's name Print or type Signer's name

If Corporation, affix Corporate Seal

NOTARY SEAL
Affidavit must be notarized for Line (2)
Subscribed and sworn to before me this
day of 20
Signature of Notary Public
of County
State of
My Commission Expires:

NOTARY SEAL
Affidavit must be notarized for Line (3)
Subscribed and sworn to before me this
day of 20
Signature of Notary Public
of County
State of
My Commission Expires:

NOTARY SEAL
Affidavit must be notarized for Line (4)
Subscribed and sworn to before me this
day of 20
Signature of Notary Public
of County
State of
My Commission Expires:

**EXECUTION OF BID
NON-COLLUSION AFFIDAVIT, DEBARMENT CERTIFICATION AND GIFT BAN CERTIFICATION
INDIVIDUAL DOING BUSINESS UNDER A FIRM NAME**

The person executing the bid, on behalf of the Bidder, being duly sworn, solemnly swears (or affirms) that neither he, nor any official, agent or employee of the bidder has entered into any agreement, participated in any collusion, or otherwise taken any action which is in restraint of free competitive bidding in connection with any bid or contract, and that the Bidder intends to do the work with its own bonafide employees or subcontractors and is not bidding for the benefit of another contractor.

In addition, execution of this bid in the proper manner also constitutes the Bidder's certification of status under penalty of perjury under the laws of the United States in accordance with the Debarment Certification attached, provided that the Debarment Certification also includes any required statements concerning exceptions that are applicable.

N.C.G.S. § 133-32 and Executive Order 24 prohibit the offer to, or acceptance by, any State Employee of any gift from anyone with a contract with the State, or from any person seeking to do business with the State. By execution of any response in this procurement, you attest, for your entire organization and its employees or agents, that you are not aware that any such gift has been offered, accepted, or promised by any employees of your organization.

SIGNATURE OF CONTRACTOR

Name of Contractor

_____ Individual name

Trading and doing business as

_____ Full name of Firm

_____ Address as Prequalified

_____ Signature of Witness

_____ Signature of Contractor, Individually

_____ Print or type Signer's name

_____ Print or type Signer's name

AFFIDAVIT MUST BE NOTARIZED

Subscribed and sworn to before me this the

NOTARY SEAL

_____ day of _____ 20__.

_____ Signature of Notary Public

of _____ County

State of _____

My Commission Expires: _____

**EXECUTION OF BID
NON-COLLUSION AFFIDAVIT, DEBARMENT CERTIFICATION AND GIFT BAN CERTIFICATION
INDIVIDUAL DOING BUSINESS IN HIS OWN NAME**

The person executing the bid, on behalf of the Bidder, being duly sworn, solemnly swears (or affirms) that neither he, nor any official, agent or employee of the bidder has entered into any agreement, participated in any collusion, or otherwise taken any action which is in restraint of free competitive bidding in connection with any bid or contract, and that the Bidder intends to do the work with its own bonafide employees or subcontractors and is not bidding for the benefit of another contractor.

In addition, execution of this bid in the proper manner also constitutes the Bidder's certification of status under penalty of perjury under the laws of the United States in accordance with the Debarment Certification attached, provided that the Debarment Certification also includes any required statements concerning exceptions that are applicable.

N.C.G.S. § 133-32 and Executive Order 24 prohibit the offer to, or acceptance by, any State Employee of any gift from anyone with a contract with the State, or from any person seeking to do business with the State. By execution of any response in this procurement, you attest, for your entire organization and its employees or agents, that you are not aware that any such gift has been offered, accepted, or promised by any employees of your organization.

SIGNATURE OF CONTRACTOR

Name of Contractor _____
Print or type Individual name

Address as Prequalified

Signature of Contractor, Individually

Print or type Signer's Name

Signature of Witness

Print or type Signer's name

AFFIDAVIT MUST BE NOTARIZED

Subscribed and sworn to before me this the
_____ day of _____ 20__.

NOTARY SEAL

Signature of Notary Public

of _____ County

State of _____

My Commission Expires: _____

DEBARMENT CERTIFICATION

Conditions for certification:

1. The prequalified bidder shall provide immediate written notice to the Department if at any time the bidder learns that his certification was erroneous when he submitted his debarment certification or explanation that is file with the Department, or has become erroneous because of changed circumstances.
2. The terms *covered transaction, debarred, suspended, ineligible, lower tier covered transaction, participant, person, primary covered transaction, principal, proposal, and voluntarily excluded*, as used in this provision, have the meanings set out in the Definitions and Coverage sections of the rules implementing Executive Order 12549. A copy of the Federal Rules requiring this certification and detailing the definitions and coverages may be obtained from the Contract Officer of the Department.
3. The prequalified bidder agrees by submitting this form, that he will not knowingly enter into any lower tier covered transaction with a person who is debarred, suspended, declared ineligible, or voluntarily excluded from participation in NCDOT contracts, unless authorized by the Department.
4. For Federal Aid projects, the prequalified bidder further agrees that by submitting this form he will include the Federal-Aid Provision titled *Required Contract Provisions Federal-Aid Construction Contract (Form FHWA PR 1273)* provided by the Department, without subsequent modification, in all lower tier covered transactions.
5. The prequalified bidder may rely upon a certification of a participant in a lower tier covered transaction that he is not debarred, suspended, ineligible, or voluntarily excluded from the covered transaction, unless he knows that the certification is erroneous. The bidder may decide the method and frequency by which he will determine the eligibility of his subcontractors.
6. Nothing contained in the foregoing shall be construed to require establishment of a system of records in order to render in good faith the certification required by this provision. The knowledge and information of a participant is not required to exceed that which is normally possessed by a prudent person in the ordinary course of business dealings.
7. Except as authorized in paragraph 6 herein, the Department may terminate any contract if the bidder knowingly enters into a lower tier covered transaction with a person who is suspended, debarred, ineligible, or voluntarily excluded from participation in this transaction, in addition to other remedies available by the Federal Government.

DEBARMENT CERTIFICATION

The prequalified bidder certifies to the best of his knowledge and belief, that he and his principals:

- a. Are not presently debarred, suspended, proposed for debarment, declared ineligible, or voluntarily excluded from covered transactions by any Federal department or agency;
- b. Have not within a three-year period preceding this proposal been convicted of or had a civil judgment rendered against them for commission of fraud or a criminal offense in connection with obtaining, attempting to obtain, or performing a public (Federal, State or local) transaction or contract under a public transaction; violation of Federal or State antitrust statutes or commission of embezzlement, theft, forgery, bribery, falsification or destruction of records; making false statements; or receiving stolen property;
- c. Are not presently indicted for or otherwise criminally or civilly charged by a governmental entity (Federal, State or local) with commission of any of the offenses enumerated in paragraph b. of this certification; and
- d. Have not within a three-year period preceding this proposal had one or more public transactions (Federal, State or local) terminated for cause or default.
- e. Will submit a revised Debarment Certification immediately if his status changes and will show in his bid proposal an explanation for the change in status.

If the prequalified bidder cannot certify that he is not debarred, he shall provide an explanation with this submittal. An explanation will not necessarily result in denial of participation in a contract.

Failure to submit a non-collusion affidavit and debarment certification will result in the prequalified bidder's bid being considered non-responsive.

Check here if an explanation is attached to this certification.

Contract No **C 202383**

County (ies): **Rowan and Davidson**

ACCEPTED BY THE
DEPARTMENT OF TRANSPORTATION

Contract Officer

Date

Execution of Contract and Bonds
Approved as to Form:

Attorney General